

RESIDENTIAL COMMERCIAL

MONO & MULTI R32

VRF SYSTEMS

**HEAT PUMP
HEAT RECOVERY**



mitsubishi
HEAVY INDUSTRIES

www.mitsubishi-termal.it





ECOLOGICAL TECHNOLOGY & INNOVATIVE DESIGN FOR A BETTER WORLD

9	RESIDENTIAL	■
51	COMMERCIAL	■
93	VRF SYSTEM	■
171	CONTROLS	■
188	ICON LEGEND	

The passion of Mitsubishi Heavy Industries leads to the development of products with a green soul, the most advanced technology today for a better future tomorrow.



R32, MORE PERFORMANCE, LOWER ENVIRONMENTAL IMPACT

ADVANTAGES OF R32

Nowadays, environmental protection is considered of primary importance by both the user and the professional.

Choosing an air conditioner with the new R32 refrigerant allows you to obtain excellent comfort in both cooling and heating, reducing polluting emissions.

The most relevant aspect of R32 gas is its GWP value, equal to 675, which allows the creation of systems containing up to 7.4 kg of gas without exceeding the threshold which requires leak control, keeping of the equipment register, a threshold which for an R410A gas is already exceeded by 2.4 kg of gas.

R32 REFRIGERANT

- it is ecological;
- it is not harmful and does not present risks for ozone;
- it is slightly flammable;
- it is very efficient.

WARNING FOR USE OF R32 GAS

R32 REFRIGERANT GAS

The specific name of R32 gas is difluoromethane. It is currently present among the fluorinated gases with a low GWP value, equal to 675, and used in air conditioning devices intended for residential use.

There is no obligation to replace the current R410A gas, which therefore remains regularly on the market, except in monosplit applications with refrigerant < 3 kg where, from 2025, the use of gas with GWP < 750 will be mandatory for new installations.

There are some limitations in particular conditions of use which must be considered in accordance with the regulations in force.

When storing units containing R32, it may be necessary, based on the quantities stored, to review the Fire Prevention Certificate (Presidential Decree 151/2011) to guarantee the validity of your insurance guarantee. The transport of dangerous goods is regulated by Legislative Decree 35/2010. R32 has been classified as slightly flammable by ISO 817 and as such has no stringent limitations in road transport (ADR in force), maintaining strict regulations in maritime transport (IMDG in force) and aeronautical (IATA in force).

THE REGULATION

The EN 378:2016 standard also regulates the applications of appliances that use R32 gas; the maximum gas concentration limits must always be verified in residential applications with particular regard to multi-split systems which can potentially concentrate (in the event of leaks) high quantities of refrigerant in small environments. R32 gas is heavier than air and in the event of a leak it accumulates at the bottom; the internal units therefore follow different regulatory parameters depending on the type of application.

Installation in public buildings is regulated by specific regulations relating to the application of appliances with flammable gases, such as: hotels Ministerial Decree 04/09/1994, shopping centers Ministerial Decree 07/27/2010, entertainment buildings Ministerial Decree 08/19/1996, hospitals Ministerial Decree 18/09/2012, schools Ministerial Decree 26/08/1992, offices Ministerial Decree 22/02/2006, games for children Ministerial Decree 16/07/2014, airports Ministerial Decree 07/07/2014, interports Ministerial Decree 18/07/2014.

DESIGN, INSTALLATION AND MAINTENANCE

The design, installation and maintenance of R32 gas appliances are regulated by the following regulations: Ministerial Decree 37/2008, provisions regarding the installation of systems inside buildings; DGLS 81/2008, text on health and safety at work; F-gas 517/2014, regulation of fluorinated gases; Presidential Decree 151/2011, regulation of procedures relating to fire prevention; EN 378:2016, refrigeration systems and heat pumps (system safety requirements).

With the Ministerial Decree of 10 March 2020 and the subsequent Circular DCPREV 9833 of 22 July 2020 by the Fire Brigade, the technical provisions are updated allowing the possibility of using, in air conditioning and air conditioning systems, machines equipped with refrigerants classified A1 or A2L, thus overcoming the constraint of using only non-toxic or non-flammable fluids.

However, it is recommended to scrupulously check the regulations in force when using equipment containing R32 gas. Failure to comply with these regulations makes designers and installers of equipment with R32 assume their direct legal responsibility for the application of the equipment itself.

R32 THE LOW GWP GAS

Mitsubishi Heavy Industries has always looked to the future and anticipated the times by offering innovative products in terms of environmental impact and efficiency. The entire range uses the eco-friendly R32 refrigerant. This gas has a low environmental impact and improves energy efficiency.

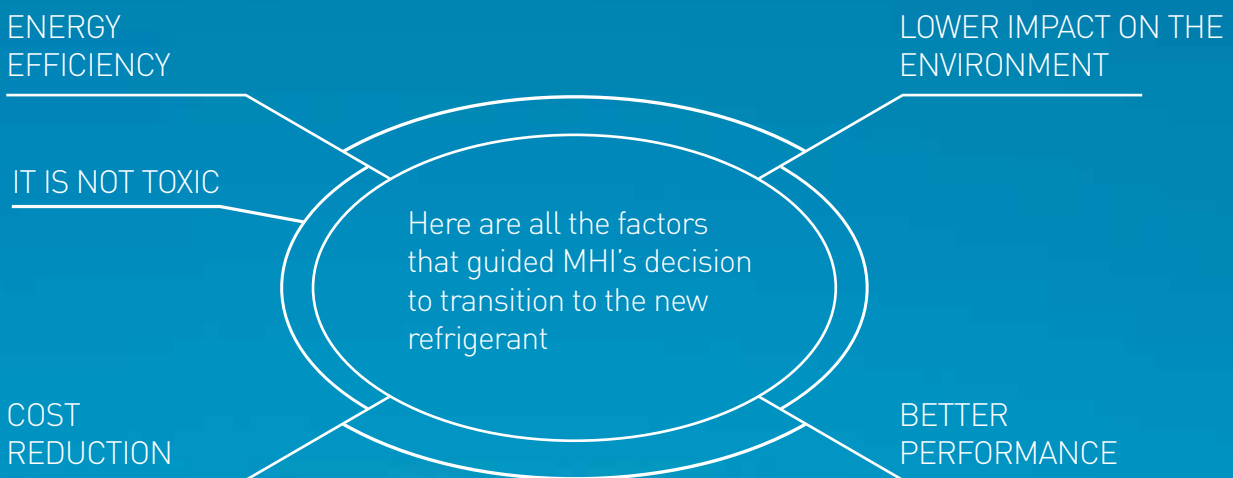

LOW GLOBAL WARMING POTENTIAL

Global warming potential is reduced by a third.

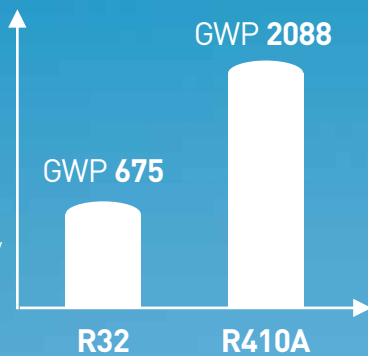

SUSTAINABILITY & SOCIAL RESPONSIBILITY

Also in 2022, Mitsubishi Heavy Industries (MHI) received a Silver rating (in the categories of environment, labor and human rights, ethics and sustainability) from EcoVadis, the independent platform that regularly evaluates Corporate Social Responsibility and sustainable purchasing.



NEW

RESIDENTIAL MONOSPLIT

NEW WALL MONOSPLIT

Introduction of 3 new capacities into the range.

KIREIA Ice



SRK 20-25-35 ZTX-WA

Heating up to -25°C outdoor.
Optimized yield and power output
for very harsh climates.

RESIDENTIAL COMMERCIAL

NEW MULTILINGUAL DESIGN CONTROL RC-ES1



Luxury Design: Compact and frameless.
Wired control with color LCD display and
touch buttons.
Connection to smartphone via Bluetooth.

RESIDENTIAL MONOSPLIT / MULTISPLIT

NEW CAPACITIES SRR

2 new capacities of 5.00 and 6.00 kW
ducted low static pressure.



SRR 25-35-50-60 ZS-W

VRF SYSTEMS

NEW HI-COP SYSTEMS IN HEAT PUMP & HEAT RECOVERY

KXZ2

KXZXE2



FDC 560~1120 KXZXE2 (20~40HP)

KXZRXE2



FDC 450~1000 KXZRXE2 (16~36HP)



RESIDENTIAL
LIGHT COMMERCIAL
R32



RESIDENTIAL & LIGHT COMMERCIAL

MONOSPLIT & MULTISPLIT RANGE



10	MONOSPLIT/MULTISPLIT R32 FEATURES
23	LINE-UP R32
24	MONOSPLIT R32
32	LIGHT COMMERCIAL R32
39	LINE-UP MULTISPLIT R32
40	MULTISPLIT R32
191	PERFORMANCE TABLES MULTISPLIT R32

Choosing the air conditioner best suited to your lifestyle is the first step to obtaining the best performance and comfort.

The air treatment, the level of silence achieved, the guaranteed energy savings are factors that make the MHI residential range the most suitable choice for every home.

HEALTH

Allergen Clear Filter, effective against Covid-19

The Allergen Clear air filter, made by MHI, is capable of capturing a wide range of germs, allergens and even viruses linked to important health complications, including the risk of Coronavirus infection.

MHI's air purification technology contains an enzyme-urea compound that suppresses pollen, mold, bacteria and allergens.

Tests* conducted by the Japan Textile Products Quality and Technology Center **confirmed that this technology is also effective for inactivating SARS-CoV-2, the virus that causes COVID-19.**

*Test conducted according to the ISO 18184 standard; number 21KB-080059-2.



PURIFICATION DEVICE PRESENT ON



1. ELISA colorimetric test method Laboratory: National Independent Hospital Agency Sagamihara Hospital, No. 1536.
 2. ELISA colorimetric test method/ELISA fluorescent method - Laboratory: National Independent Hospital Agency Sagamihara Hospital, No. 1536. 3. TCID test method (infection value 50%) Laboratory: Kitazato Environmental Science Center Foundation Japan, no. 15-0145.

TEST

The quantity of SARS-CoV-2, present on a sample of infected material, after one hour of exposure to the Allergen Clear filter, **is reduced by 99.998%.**

The virus is deactivated by MHI's urea-enzyme technology.

Sample before being exposed to the filter Sample after one hour in contact with the Allergen Clear filter

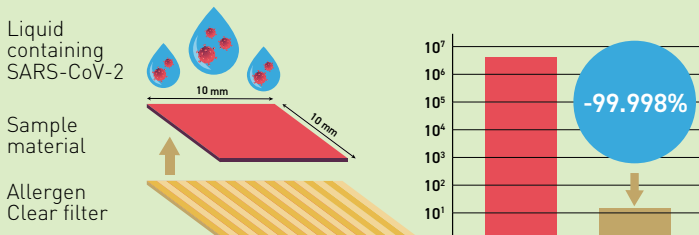

The continuous operation of the internal fan and the consequent filtration of the air reduces the presence of viruses in the environment and helps limit the risk of infections and allergies.



EFFICIENCY IN CLASS A+++

In order to improve energy efficiency and protect the environment, several design and engineering changes have been made. The entire residential and light commercial range from Mitsubishi Heavy Industries stands out for its high energy performance.

Significant energy savings in both cooling and heating have been achieved thanks to the DC PAM Inverter technology and the DC Twin Rotary compressor.



INVERTER DC PAM

The inverter-driven system has a number of performance advantages over a conventional system. For example, compressor outputs can ensure rapid warm-up on startup and reach the set temperature more quickly.

The air conditioner then slows down the speed of the compressor to save energy while maintaining comfortable conditions.

DC TWIN ROTARY COMPRESSOR

The recently developed compressor has high-level performance at both low and high speeds.

In addition to low vibrations, low noise emissions and high efficiency were achieved by optimizing the dimensions of the mechanical parts and applying the neodymium motor.

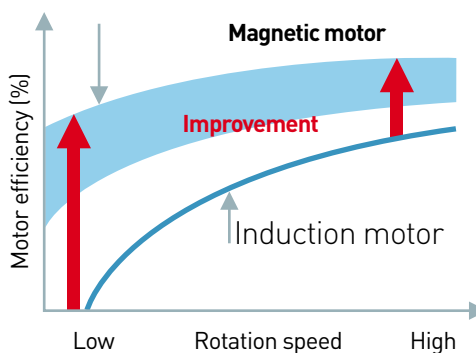
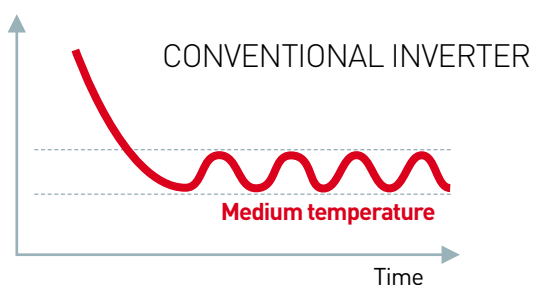
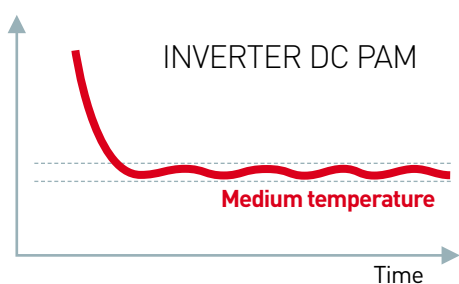

Compared to the conventional inverter, the DC PAM optimizes temperature control, making it more stable over time.

HIGH TECHNOLOGY FOR OUTDOOR UNITS

MHI outdoor units are well-finished and robust and can be easily installed on a roof or terrace, or simply against an external wall. The design and materials of the body are the result of the careful work of MHI engineers; Japanese technology for maximum efficiency.

HELICAL FAN

Optimization of the combination of the helical fan with the fan motor: the same power as the previous model is maintained, with lower electricity consumption.

The synergy with the leaf-shaped grill increases efficiency by 5%, with attenuation of the sound level.



Serrated fan

LEAF-SHAPED GRILLE

The radial-shaped grille was developed to allow efficient airflow to escape. Reducing the load on the motor and axial fan leads to greater energy efficiency, also contributing to a quieter sound level.

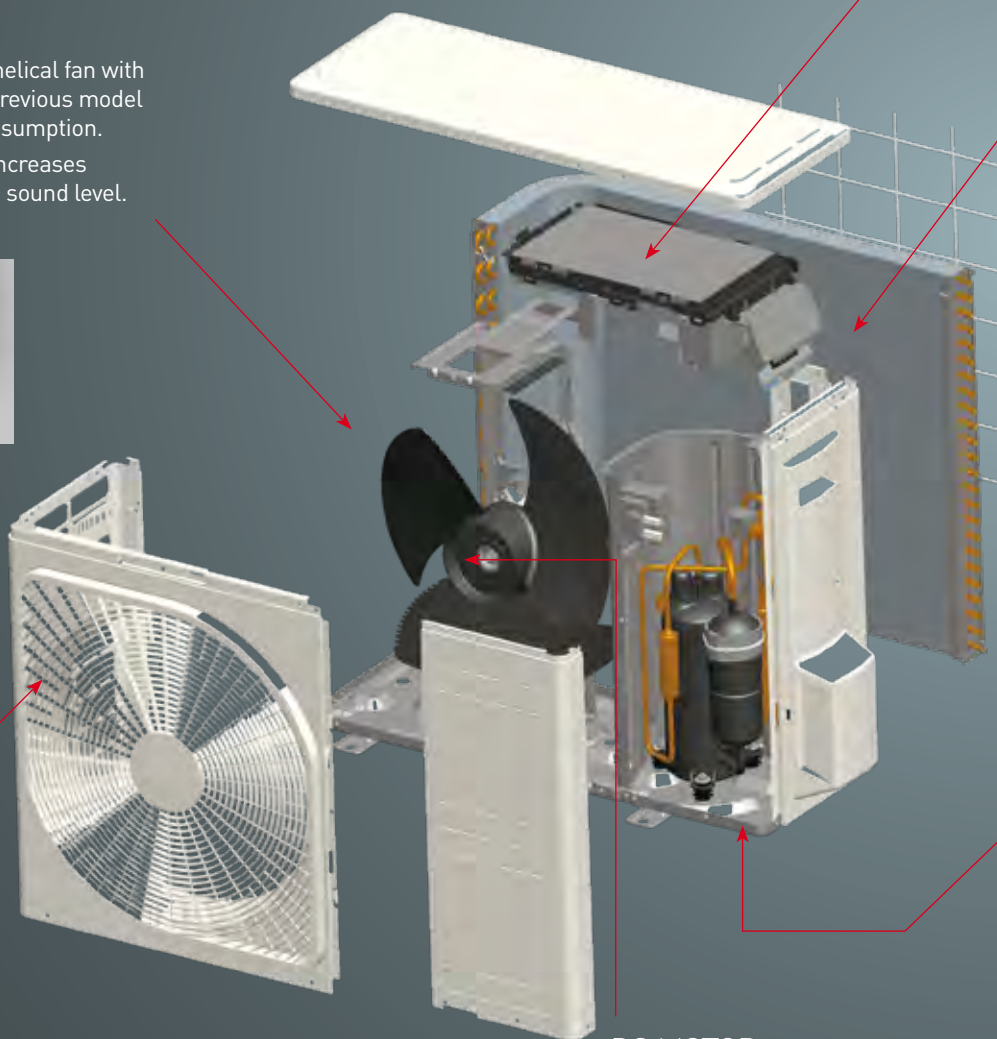

DC MOTOR

The fan motor produces high efficiency and high power.

PCB CLADDING

The PCB of the outdoor unit is coated. As it is resistant to humidity, it is long-lasting.

HEAT EXCHANGER

By changing the fin configuration from flat to "M" shape, efficiency increased by 10%. This multi-dimensional structure offers an optimal balance of heat transfer and airflow.



HOT DIP STEEL SHEET WITH HIGH ANTI-CORROSION RESISTANCE

At the base of the outdoor units, a hot-dipped steel sheet with high resistance to corrosion is used.

It possesses superior anti-corrosion resistance, and anti-scratch properties compared to conventional materials.



THREE SENSORS

Room temperature control is very important for comfortable living. The use of three sensors - to control the internal temperature, internal humidity and external temperature - allows optimal air conditioning to be achieved.



Indoor temperature and humidity sensor



Outdoor temperature sensor

INDOOR UNIT'S HEAT EXCHANGER

Our optimal combination of fin configuration with copper tubing maximized airflow, without increasing the width of the indoor unit.

The efficiency rate of the heat exchanger has been significantly improved by 33% compared to that of previous models. The fin is able to maximize airflow volume and save energy simultaneously.



This page mainly describes the ZSX and ZTX series.

MAXIMUM SAVINGS WITH THE HUMAN SENSOR

It is an activity sensor that guarantees automatic control of energy saving. It detects not only the presence/absence of people in the environment, but also the type of activity carried out. The units highlighted below therefore adjust their cooling and heating capacities based on the real needs of the environment in which they are installed, in relation to the perception of those present.

Models on
which the
sensor can be
installed



ZSX e ZTX
(standard)



FDT



FDTC



FDUM



FDE



ECO OPERATION BY HUMAN SENSOR

IN COOLING MODE

The unit activates energy saving when low activity is detected, and automatically raises the outlet air temperature.



IN HEATING MODE

The unit activates energy saving when intense physical activity is detected, and automatically lowers the outlet air temperature.



When the sensor detects that no people are in the room, the unit automatically reduces the power output to a moderate level after approximately 15 minutes; it will return to normal operation once people reenter the room.

AUTO OFF BY HUMAN SENSOR

If after 1 hour (settable from 1 to 2 hours by remote control) the environment continues to be free of people, the unit stops operation and switches to "stand-by" mode.

It starts up again when any human activity is detected within 12 hours, or turns off completely after 12 hours of absence.

It is possible to activate and deactivate the AUTO OFF function from the remote control.

ABSENCE



Power control: when the system detects that no one is present in the room, the air flow stops.

AFTER 1 OR 2 HOURS (SELECTABLE)

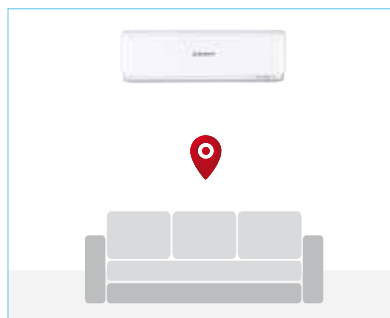

Stand by: the unit suspends operation if it detects no activity for 1 hour. It comes back to work if and when activity resumes.

PEOPLE IN THE ROOM



Reactivation of the function: if you return to the room within 12 hours, the air conditioner automatically resumes working in the preset mode.

By activating any manual timing setting [Sleep timer, Timer on/off, Weekly timer] the HUMAN SENSOR is inhibited.

FUZZY AUTO OPERATION

Fuzzy Auto Operation guarantees automatic control of the comfort temperature even in the presence of climate change.

COMFORT & BENEFITS MHI TAKES CARE OF YOU

Ensuring the most complete well-being for people is a prerogative of MHI: through numerous operational functions, the residential models ensure comfort during the night hours, control of humidity levels in the environment and the ideal temperature at any time of the year.



HIGH POWER: ENHANCED MODE

This mode offers an extra air flow to quickly bring the room (in heating or cooling mode) to the desired temperature.

Useful in both the winter and summer seasons, the HIGH POWER function guarantees enhanced hot air to enjoy a pleasant warmth when waking up on winter days, or fresh air when returning home on a hot summer day.

After 15 minutes, the air conditioner automatically restores the previous operating mode, to prevent the room from heating up or cooling down excessively.

WEEKLY TIMER

For each day of the week, up to 4 timer programmings are available (ON-TIMER, programmed automatic start / OFF-TIMER, programmed automatic stop).

You can set up to 28 programs per week. Once selected, this mode will repeat the same programming every week, unless otherwise set or cancelled.

HUMIDITY UNDER CONTROL

The perceived temperature in a room also depends on the degree of humidity. Dehumidification removes humidity from the air, lowering the perceived temperature during the summer period.

NIGHT SET-BACK MODE

During cold seasons, it is possible to keep the room temperature at a comfortable level in case of absence, at night and when the room is empty.

The air conditioner maintains a constant temperature of approximately 10° C.

SLEEP TIMER: NIGHT FUNCTION

During night rest, excessive cooling/heating is not necessary.

Thanks to this function, it is possible to obtain moderate cooling/heating by regulating the power, also ensuring energy savings.

IN HEATING MODE

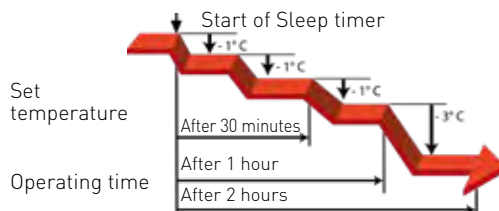

IN COOLING MODE

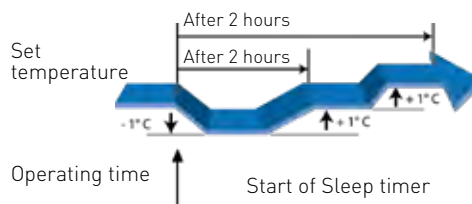

BREATHING HEALTHY AIR FILTERS & DISINFECTION

Wellbeing and healthiness also pass through the air we breathe. This is why Mitsubishi Heavy Industries makes our environments comfortable by sanitizing and, at the same time, evenly distributing the air from the air conditioners. In particular, the filters and the structure of the residential models perform a high filtering action: they remove dust, preventing the formation of fungi and mold, and exert a profound deodorizing action.

ALLERGEN CLEAR FILTER, ALSO EFFECTIVE AGAINST COVID



Carbonic acid diamide

The anti-allergy filter eliminates pollen¹, lice², allergens that live on cat hair, etc. and deactivates them.

The secret of deactivation is the enzyme-diamide compound of carbonic acid. Deactivation concerns not only allergens but also all types of bacteria², molds and viruses³.

The Allergen Clear air filter, made by MHI, is capable of capturing a wide range of germs, allergens and even viruses linked to important health complications, including the risk of Coronavirus infection.

1. ELISA colorimetric test method Laboratory: National Independent Hospital Agency Sagamihara Hospital, No. 1536. 2. ELISA colorimetric test method/ELISA fluorescent method - Laboratory: National Independent Hospital Agency Sagamihara Hospital, No. 1536. 3. TCID test method (infection value 50%) Laboratory: Kitazato Environmental Science Center Foundation Japan, no. 15-0145.

ALLERGEN CLEAR FUNCTION

The Allergen Clear function is a real thermo/mechanical sanitization program: it is activated by remote control, lasts an hour and a half and is completed with the activation of the Self Clean Operation and then stops automatically.

This function neutralizes the bacteria collected on the surface of the special anti-allergenic filter (Diamide of Carbonic Acid), thanks to a sophisticated interaction between temperature and humidity control which activates the hydrolytic functions of the filter enzymes.

The 4 phases of the Allergen Clear function

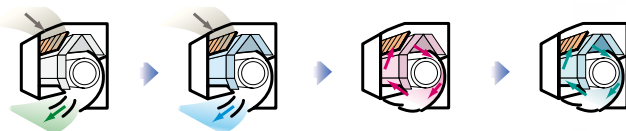

1. It captures allergens
2. Cooling: condensate production on the heat exchanger
3. Heating: distribution of hot condensed water on the filter to neutralize allergens.
4. Activation of the Self Clean function for drying

ANTI-MICROBIAL FAN TREATMENT

To always keep the indoor unit clean, the fan has been subjected to anti-microbial treatment to resist mold and germs, making the system clean and safe.

without anti-microbial



with anti-microbial

Below is an example of the comparison between the growth of bacteria and mold on fan surfaces (microscope image).

Model	SRK ZSX-WF	SRK ZS-WF	SRK ZTX-WA	SRK ZSP-W	SRK ZTL-W	SRK ZR-WF	SRF ZS-W	SRR ZS-W
ALLERGEN CLEAR	✓	✓	✓		✓	✓		
Dustproof	✓	✓	✓	✓		✓	✓	
Photocatalytic	✓	✓	✓			✓	✓	
Self Clean Operation	✓	✓	✓	✓	✓	✓	✓	✓

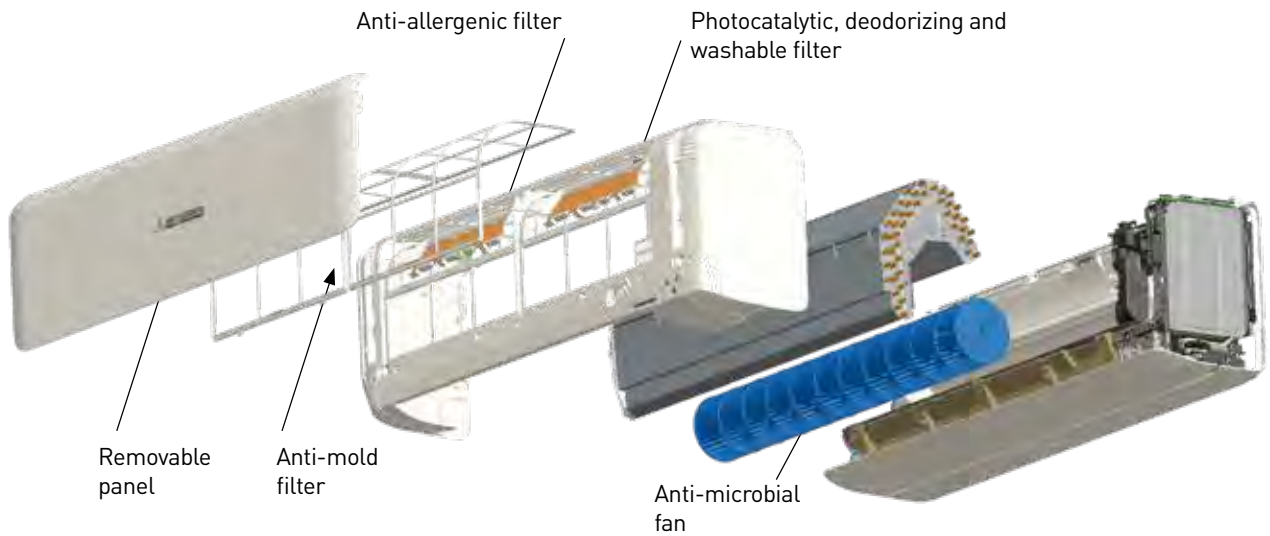

SELF CLEAN OPERATION

This function activates the automatic mold sanitization program and can be performed at the end of the machine's operating cycle (or as the last phase of the Allergen Clear function). It lasts a couple of hours. The proliferation of mold is blocked through a thermo/mechanical process.

Example

When the "Self Clean Operation" is NOT performed for a week



Expansion of fungal mycelium and mold spores

When the "Self Clean Operation" is performed



Mold spores do not germinate



TITANIUM DIOXIDE + ZEOLITE PHOTOCATALYTIC FILTER

In non-woven fabric with TiO2 powders + Zeolite

Deodorizing and washable, it keeps the air fresh by neutralizing the molecules that cause bad odor. The deodorizing power can be restored by simply washing with water and drying under the sun.



VENTILATION AIR DISTRIBUTION

Jet Air technology for silent, wide-ranging airflow. MHI has used the same aerodynamic analysis technology used in the development of jet engines for its air conditioners.



3D AIRFLOW, SILENT AND LARGE REACHING

For the design of the components of the air flow system of the KIREIA Plus, KIREIA, KIREIA Ice and KIREIA EVO models, MHI made use of aeronautical technology, thanks to which the units are able to distribute an air flow in the environment large and uniform, with a notable reduction in consumption and sound levels: only 19 dB(A) for the 2.00, 2.50 and 3.50 kW models and for the 1.50 and 2.00 kW models (KIREIA Evo).

The automatic control of the volume and direction of the air flow guarantees a comfortable and uniform climate in the room.

Through this control it is possible to prevent any air current that is too cold or too hot from being directly directed towards those present in the room.

In heating mode, the flow of warm air can be directed towards the floor, thus achieving an optimal degree of comfort.

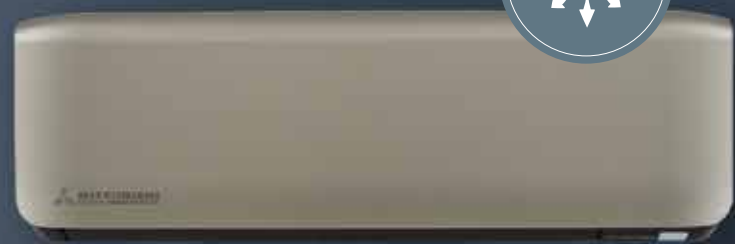

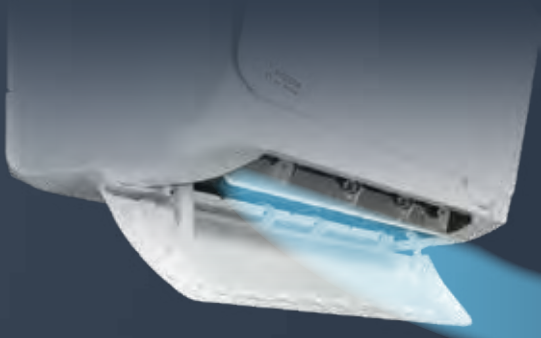

UP TO 20 METERS



DOUBLE FLAP (small & large)

The double flap controls the optimization of the air flow: horizontal and long in cooling, strong and downwards in heating.

WIDE RANGE AIRFLOW

Jet technology allows you to reach the corners of large environments. Ideal for large living rooms, shops, offices.

HORIZONTAL SWINGING OF AIR OUTLET FLAPS IN 8 DIFFERENT DIRECTIONS

It is possible to individually manage the flow direction of the air outlet flaps: 8 different horizontal swinging modes, selectable from the remote control, to choose to direct the air in the direction we most desire and thus achieve the optimal level of comfort.

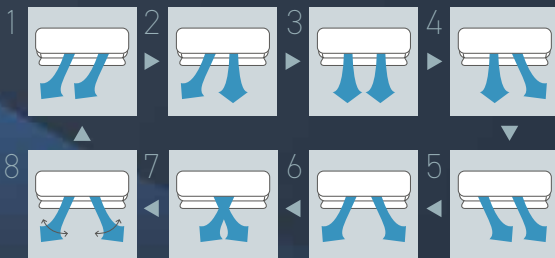

3D AUTO PROGRAMMING

High Power

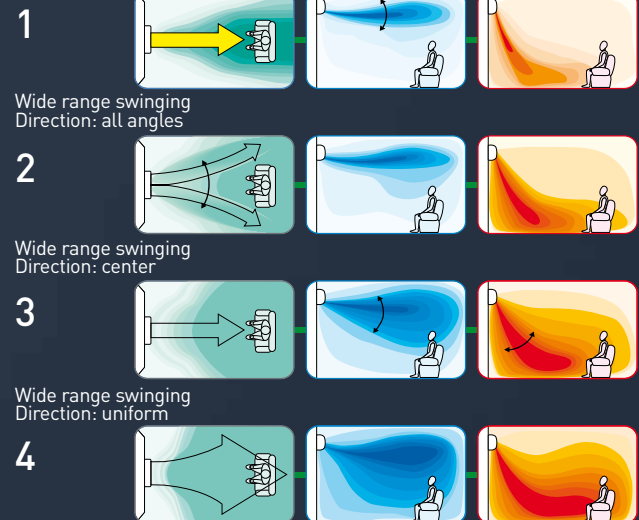

Wide range swinging
Direction: all angles

Wide range swinging
Direction: center

Wide range swinging
Direction: uniform

This programming, selectable from the remote control, allows with a single button, to activate three independent air flows, generating a uniform breeze that reaches every point of the room.

In cooling mode, the cooled air does not go directly on the people in the room but flows on the ceiling and comfort is perceived as a fresh breeze. In heating, the flow of hot air spreads directly onto the floor.

On this page, where not specified, the characteristics refer to the KIREIA Plus, KIREIA, KIREIA Ice and KIREIA Evo models.



A FRESH WIND OF ADVANTAGES

The KIREIA Plus, KIREIA, KIREIA Ice and KIREIA Evo wall models are at the top for ease of installation, construction quality and advanced features.

WIDE OPERATION

The advanced technology of MHI air conditioners has extended heating and cooling operations. The outdoor unit operates down to a temperature of -20°C.

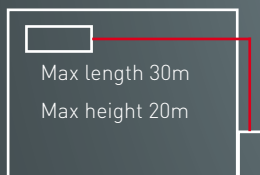
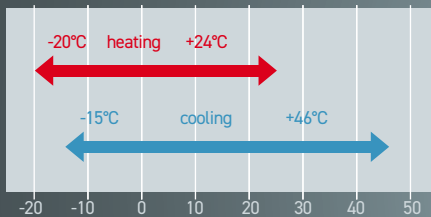

SPLITTING DISTANCE

Up to 30 meters for maximum design flexibility.

Ssshhh QUIET...

When silent mode is selected, the maximum pressure level of the outdoor unit will be 3 dB(A) lower than the standard rated level [45 dB(A) or less].

The compressor speed is set lower than nominal operation, at 60% of nominal power. The maximum fan speed on the outdoor unit is lower than rated operation.

The KIREIA Plus, KIREIA and KIREIA Ice indoor units have some of the lowest sound pressure levels on the market [mod. 2.00, 2.50 and 3.50 kW].

MOBILE PANEL

Advanced design and technology: the mobile air intake panel has been designed to further reduce resistance.



KIREIA PLUS, AN ALL-ITALIAN DESIGN

Soft lines, great attention to detail and authentic exclusivity. Two colors available, white and titanium, which blend in with the home furnishings. Italian design that also wins abroad, with the Silver A'Design Award'.



BRIGHTNESS ADJUSTMENT

The brightness of the LED display can be adjusted to your preference (for ZSX, ZS, ZTL and ZTX models).



YOUR PREFERENCES JUST A CLICK AWAY!

Maintaining the same operating mode, temperature, fan speed and air flow direction is now possible thanks to the 'Pre-Set' function, which can be activated by remote control: this function is able to memorize and recall the last settings selected, for total comfort.

RESIDENTIAL MONOSPLIT R32

		kw	1.50	2.00	2.50	3.50	4.00	4.50	5.00	6.00	6.30	7.10	8.00
WALL	KIREIA Plus SRK ZSX-WF SRK ZSX-WFT <i>titanium</i>			✓	✓	✓			✓	✓			
	KIREIA SRK ZS-WF SRK ZS-WFT <i>titanium</i>			✓	✓	✓			✓				
	KIREIA Ice SRK ZTX-WA			✓	✓	✓							
	KIREIA Smart SRK ZSP-W				✓	✓			✓				
	KIREIA Evo SRK ZTL-W		✓	✓	✓	✓			✓		✓	✓	
	LARGE COMFORT SRK ZR-WF										✓	✓	✓
FLOOR	PRIMARY HEATING Console SRF ZS/ZSX-W				✓	✓			✓				
DUCTED	LIGHT COMMERCIAL Low pressure head SRR ZS-W				✓	✓			✓	✓			
	LIGHT COMMERCIAL Medium pressure head FDUM VH						✓		✓	✓			
CEILING	LIGHT COMMERCIAL FDE VH						✓		✓	✓			
CASSETTE	LIGHT COMMERCIAL FDTC VH(1) 60x60				✓	✓	✓		✓	✓			
	LIGHT COMMERCIAL FDT VH 84x84						✓		✓	✓			

KIREIA Plus

WALL



titanium



SRC 20-35 ZSX-W
SRC 50-60 ZSX-W3

SRK 20-60 ZSX-WF
SRK 20-60 ZSX-WFT



<REMOTE CONTROL INCLUDED>



Indoor unit model		SRK 20 ZSX-WF(T)	SRK 25 ZSX-WF(T)	SRK 35 ZSX-WF(T)	SRK 50 ZSX-WF(T)	SRK 60 ZSX-WF(T)	
Outdoor unit model		SRC 20 ZSX-W	SRC 25 ZSX-W	SRC 35 ZSX-W	SRC 50 ZSX-W3	SRC 60 ZSX-W3	
Type		DC-Inverter Heat pump					
Control (included)		Remote control					
Nominal data							
Rated capacity (T=+35°C)	Cooling	kW	2.00 (0.90~3.40)	2.50 (0.90~3.80)	3.50 (0.90~4.50)	5.00 (1.00~6.20)	6.10 (1.00~6.90)
		kW	0.31 (0.16~0.76)	0.44 (0.16~0.91)	0.74 (0.16~1.27)	1.24 (0.19~1.90)	1.71 (0.19~2.50)
		EER ¹	6.45	5.68	4.73	4.03	3.57
Rated capacity (T=+7°C)	Heating	kW	2.70 (0.80~5.50)	3.20 (0.80~6.00)	4.30 (0.80~6.80)	6.00 (0.80~8.20)	6.80 (0.80~8.80)
		kW	0.47 (0.14~1.36)	0.59 (0.14~1.54)	0.90 (0.14~1.87)	1.36 (0.20~2.46)	1.65 (0.20~2.86)
		COP ¹	5.74	5.42	4.78	4.41	4.12
Seasonal data							
Design load (Pdesignc)	Cooling	kW	2.00	2.50	3.50	5.00	6.10
		SEER ²	10.00	10.30	9.50	8.30	7.80
		626/2011 ³	A+++	A+++	A+++	A++	A++
Annual energy consumption	Heating (average climate conditions)	kWh/y	70	85	129	211	274
		kWh/y	2.80	3.00	3.40	4.50	5.20
Design load (Pdesignh) @ -10°C	Heating (average climate conditions)	SCOP ²	5.20	5.20	5.10	4.70	4.70
		626/2011 ³	A+++	A+++	A+++	A++	A++
Annual energy consumption	Heating (average climate conditions)	kWh/y	754	808	934	1341	1551
		kWh/y	754	808	934	1341	1551
Electrical data							
Power supply	Outdoor unit	Ph-V-Hz	1Ph - 220/240V - 50Hz				
Power cable		Type	3 x 2.5 mm ²	3 x 2.5 mm ²	3 x 2.5 mm ²	3 x 4 mm ²	
Wiring cables I.U./O.U.		nb.	4	4	4	4	
Nominal absorbed current	Cooling	A	1.80	2.40	3.50	5.40	
	Heating	A	2.50	3.00	4.30	6.00	
Max current		A	9.00	9.00	9.00	15.00	
Max power input		kW	1.92	1.92	1.92	2.90	
Refrigerant circuit data							
Refrigerant ⁴		Type (GWP)	R32 (675)				
Refrigerant precharge		Kg	1.2	1.2	1.2	1.3	
Tons of CO ₂ equivalent		t	0.810	0.810	0.810	0.878	
Diameter of refrigerant pipings liquid/gas		mm (inch.)	6.35(1/4") - 9.52(3/8")	6.35(1/4") - 9.52(3/8")	6.35(1/4") - 9.52(3/8")	6.35(1/4") - 12.74(1/2")	
Max splitting distance		m	25	25	25	30	
Max splitting level difference I.U./O.U.		m	15	15	15	20	
Max. splitting without additional charge		m	15	15	15	15	
Additional charge		g/m	20	20	20	20	
Indoor unit specifications							
Dimensions	LxDxH	mm	920x220x305	920x220x305	920x220x305	920x220x305	
Net weight		Kg	13	13	13	13	
Sound power level	Max	dB(A)	55	56	58	62	
Sound pressure level (Hi/Me/Lo/U/Lo)	Cooling	dB(A)	38/31/24/19	39/33/25/19	43/35/26/19	44/39/31/22	
	Heating	dB(A)	38/33/25/19	40/34/27/19	42/35/28/19	47/41/33/23	
Air flow volume (Hi/Me/Lo/U/Lo)	Cooling	m ³ /h	678/546/360/300	732/600/402/300	786/648/438/300	858/744/468/324	
	Heating	m ³ /h	732/618/432/324	768/660/468/324	834/708/516/324	1038/858/588/372	
Outdoor unit specifications							
Dimensions	LxDxH	mm	800(+71)x290x640	800(+71)x290x640	800(+71)x290x640	800(+71)x290x640	
Net weight		Kg	43	43	43	45	
Sound power level	Max	dB(A)	58	58	62	63	
Sound pressure level	Max	dB(A)	45	45	48	51	
Air flow volume	Max	m ³ /h	1860	1860	2160	2340	
Operating range (outdoor temperature)	Cooling	°C	-15~46				
	Heating	°C	-20~24				
Optional parts							
Wi-Fi module			Included				
Interface for home automation connection and wired controls			SC-BIKN2-E				

1. Value measured according to harmonised standard EN14511. 2. EU Regulation N.206/2012 - - Value measured according to harmonised standard EN14825. 3. Delegated Regulation UE N.626/2011 with regard to energy labelling indicating the energy consumption of air conditioners. 4. Refrigerant leakage contributes to climate change. When released into the atmosphere, refrigerants with a lower global warming potential (GWP) contribute less to global warming than those with a higher GWP. This appliance contains a refrigerant with a GWP of 675. If 1 kg of this refrigerant fluid were released into the atmosphere, therefore, the impact on global warming would be 675 times higher than 1 kg of CO₂ over a period of 100 years. Under no circumstances should the user try to intervene on the refrigerant circuit or disassemble the product. Always contact qualified personnel if necessary. 5. Home automation protocols available: KNX, Modbus, BACnet. The use of the SC-BIKN2-E interface card inhibits some functions of the unit. Contact your contact person for further details.

KIREIA

WALL

R32



titanium



SRC 20 ZS-W

SRC 50 ZS-W

SRK 20~50 ZS-WF
SRK 20~50 ZS-WFT



<INCLUDED>



<ALLERGEN CLEAR FILTER>



<REMOTE CONTROL INCLUDED>

SRC 25~35 ZS-W2



Indoor unit model	SRK 20 ZS-WF(T)		SRK 25 ZS-WF(T)		SRK 35 ZS-WF(T)		SRK 50 ZS-WF(T)	
Outdoor unit model	SRC 20 ZS-W		SRC 25 ZS-W2		SRC 35 ZS-W2		SRC 50 ZS-W	
Type	DC-Inverter Heat pump							
Control (included)	Remote control							
Nominal data								
Rated capacity (T=+35°C)	Cooling	kW	2.00 (0.90~2.90)	2.50 (0.90~3.10)	3.50 (0.90~4.00)	5.00 (1.30~5.50)		
Rated power input (T=+35°C)		kW	0.44 (0.19~0.80)	0.62 (0.19~0.90)	0.89 (0.17~1.24)	1.35 (0.29~1.80)		
Rated energy efficiency coefficient		EER ¹	4.55	4.03	3.93	3.70		
Rated capacity (T=+7°C)	Heating	kW	2.70 (0.90~4.30)	3.20 (0.90~4.50)	4.00 (0.90~5.00)	5.80 (1.30~6.60)		
Rated power input (T=+7°C)		kW	0.59 (0.20~1.40)	0.74 (0.20~1.42)	0.94 (0.19~1.45)	1.56 (0.25~1.98)		
Rated energy performance coefficient		COP ¹	4.58	4.32	4.26	3.72		
Seasonal data								
Design load (Pdesignc)	Cooling	kW	2.00	2.50	3.50	5.00		
Seasonal energy efficiency index		SEER ²	8.50	8.50	8.40	7.00		
Seasonal energy efficiency class		626/2011 ³	A+++	A+++	A++	A++		
Annual energy consumption		kWh/y	83	103	146	250		
Design load (Pdesignh) @ -10°C	Heating (average climate conditions)	kW	2.60	2.70	3.00	3.80		
Seasonal energy efficiency index		SCOP ²	4.60	4.70	4.70	4.60		
Seasonal energy efficiency class		626/2011 ³	A++	A++	A++	A++		
Annual energy consumption		kWh/y	793	804	895	1158		
Electrical data								
Power supply	Outdoor unit	Ph-V-Hz	1Ph - 220/240V - 50Hz					
Power cable		Type	3 x 2.5 mm ²	3 x 2.5 mm ²	3 x 2.5 mm ²	3 x 4 mm ²		
Wiring cables I.U./O.U.		nb.	4	4	4	4		
Nominal absorbed current	Cooling	A	2.50	3.10	4.20	5.90		
	Heating	A	3.00	3.60	4.40	6.90		
Max current		A	9.00	9.00	9.00	14.50		
Max power input		kW	1.65	1.65	1.65	2.68		
Refrigerant circuit data								
Refrigerant ⁴		Type (GWP)	R32 (675)					
Refrigerant precharge		Kg	0.62	0.62	0.78	1.05		
Tons of CO2 equivalent		t	0.419	0.419	0.527	0.709		
Diameter of refrigerant pipings liquid/gas		mm (inch.)	6.35(1/4") - 9.52(3/8")	6.35(1/4") - 9.52(3/8")	6.35(1/4") - 9.52(3/8")	6.35(1/4") - 12.74(1/2")		
Max splitting distance		m	20	20	20	25		
Max splitting level difference I.U./O.U.		m	10	10	10	15		
Max. splitting without additional charge		m	15	15	15	15		
Additional charge		g/m	20	20	20	20		
Indoor unit specifications								
Dimensions	LxDxH	mm	870x230x290	870x230x290	870x230x290	870x230x290		
Net weight		Kg	9.5	9.5	9.5	10		
Sound power level	Max	dB(A)	50	53	56	60		
Sound pressure level (Hi/Me/Lo/ULo)	Cooling	dB(A)	34/25/22/19	36/28/23/19	40/30/26/19	46/36/29/22		
	Heating	dB(A)	36/29/23/19	39/30/24/19	41/36/25/19	46/37/31/24		
Air flow volume (Hi/Me/Lo/ULo)	Cooling	m ³ /h	558/420/354/300	594/480/354/300	678/522/420/300	726/594/444/354		
	Heating	m ³ /h	600/510/390/354	678/522/402/354	738/660/420/336	834/672/546/444		
Outdoor unit specifications								
Dimensions	LxDxH	mm	780(+62)x290x540	780(+62)x290x540	780(+62)x290x540	780(+62)x290x595		
Net weight		Kg	31.5	31	34.5	36		
Sound power level	Max	dB(A)	56	58	61	63		
Sound pressure level	Max	dB(A)	45	46	50	52		
Air flow volume	Max	m ³ /h	1482	1644	1890	1968		
Operating range (outdoor temperature)	Cooling	°C	-15~46					
	Heating	°C	-15~24					
Optional parts								
Wi-Fi module			Included					
Interface for home automation connection and wired controls			SC-BIKN2-E					

1. Value measured according to harmonised standard EN14511. 2. EU Regulation N.206/2012 -- Value measured according to harmonised standard EN14825. 3. Delegated Regulation UE N.626/2011 with regard to energy labelling indicating the energy consumption of air conditioners. 4. Refrigerant leakage contributes to climate change. When released into the atmosphere, refrigerants with a lower global warming potential (GWP) contribute less to global warming than those with a higher GWP. This appliance contains a refrigerant with a GWP of 675. If 1 kg of this refrigerant fluid were released into the atmosphere, therefore, the impact on global warming would be 675 times higher than 1 kg of CO2, over a period of 100 years. Under no circumstances should the user try to intervene on the refrigerant circuit or disassemble the product. Always contact qualified personnel if necessary. 5. Home automation protocols available: KNX, Modbus, BACnet. The use of the SC-BIKN2-E interface card inhibits some functions of the unit. Contact your contact person for further details.

KIREIA Ice

WALL



<INCLUDED>

<ALLERGEN CLEAR FILTER>

<REMOTE CONTROL INCLUDED>

SRK 20~35 ZTX-WA

SRC 20~35 ZTX-WA



Indoor unit model	SRK 20 ZTX-WA		SRK 25 ZTX-WA		SRK 35 ZTX-WA	
Outdoor unit model	SRC 20 ZTX-WA		SRC 25 ZTX-WA		SRC 35 ZTX-WA	
Type	DC-Inverter Heat pump					
Control (included)	Remote control					
Nominal data						
Rated capacity (T=+35°C)	Cooling	kW	2.00 (0.90~3.50)	2.50 (0.90~3.80)	3.50 (0.90~4.50)	
Rated power input (T=+35°C)		kW	0.32 (0.16~0.77)	0.45 (0.16~0.91)	0.74 (0.16~1.18)	
Rated energy efficiency coefficient		EER ¹	6.25	5.56	4.73	
Rated capacity (T=+7°C)	Heating	kW	2.70 (0.90~7.60)	3.20 (0.90~7.80)	4.30 (0.90~8.00)	
Rated power input (T=+7°C)		kW	0.47 (0.17~2.31)	0.59 (0.17~2.45)	0.87 (0.17~2.50)	
Rated energy performance coefficient		COP ¹	5.74	5.42	4.94	
Seasonal data						
Design load (Pdesignc)	Cooling	kW	2.00	2.50	3.50	
Seasonal energy efficiency index		SEER ²	9.60	9.50	9.50	
Seasonal energy efficiency class		626/2011 ³	A+++	A+++	A+++	
Annual energy consumption		kWh/y	73	93	129	
Design load (Pdesignh) @ -10°C	Heating (average climate conditions)	kW	2.80	3.00	3.40	
Seasonal energy efficiency index		SCOP ²	5.20	5.20	5.10	
Seasonal energy efficiency class		626/2011 ³	A+++	A+++	A+++	
Annual energy consumption		kWh/y	755	808	934	
Electrical data						
Power supply	Outdoor unit	Ph-V-Hz	1Ph - 220/240V - 50Hz			
Power cable		Type	3 x 2.5 mm ²	3 x 2.5 mm ²	3 x 2.5 mm ²	
Wiring cables I.U./O.U.		nb.	4	4	4	
Nominal absorbed current	Cooling	A	1.60	2.10	3.40	
	Heating	A	2.20	2.70	4.10	
Max current		A	14.50	14.50	14.50	
Max power input		kW	2.54	2.70	2.75	
Refrigerant circuit data						
Refrigerant ⁴		Type (GWP)	R32 (675)			
Refrigerant precharge		Kg	1.25	1.25	1.25	
Tons of CO2 equivalent		t	0.844	0.844	0.844	
Diameter of refrigerant pipings liquid/gas		mm (inch.)	6.35(1/4") - 9.52(3/8")	6.35(1/4") - 9.52(3/8")	6.35(1/4") - 9.52(3/8")	
Max splitting distance		m	25	25	25	
Max splitting level difference I.U./O.U.		m	15	15	15	
Max. splitting without additional charge		m	15	15	15	
Additional charge		g/m	20	20	20	
Indoor unit specifications						
Dimensions	LxDxH	mm	920x220x305	920x220x305	920x220x305	
Net weight		Kg	13	13	13	
Sound power level	Max	dB(A)	53	55	57	
Sound pressure level (Hi/Me/Lo/ULo)	Cooling	dB(A)	38/31/24/19	39/33/25/19	43/35/26/19	
	Heating	dB(A)	40/33/25/19	41/34/27/19	42/35/28/19	
Air flow volume (Hi/Me/Lo/ULo)	Cooling	m ³ /h	642/516/348/288	702/576/384/288	792/618/420/288	
	Heating	m ³ /h	852/624/432/336	888/660/468/324	918/708/516/336	
Outdoor unit specifications						
Dimensions	LxDxH	mm	800(+71)x290x640	800(+71)x290x640	800(+71)x290x640	
Net weight		Kg	45	45	45	
Sound power level	Max	dB(A)	57	57	59	
Sound pressure level	Max	dB(A)	45	45	47	
Air flow volume	Max	m ³ /h	1860	1860	2148	
Operating range (outdoor temperature)	Cooling	°C	-15~46			
	Heating	°C	-25~24			
Optional parts						
Wi-Fi module			Included			
Interface for home automation connection and wired controls			SC-BIKN2-E			

1. Value measured according to harmonised standard EN14511. 2. EU Regulation N.206/2012 - - Value measured according to harmonised standard EN14825. 3. Delegated Regulation UE N.626/2011 with regard to energy labelling indicating the energy consumption of air conditioners. 4. Refrigerant leakage contributes to climate change. When released into the atmosphere, refrigerants with a lower global warming potential (GWP) contribute less to global warming than those with a higher GWP. This appliance contains a refrigerant with a GWP of 675. If 1 kg of this refrigerant fluid were released into the atmosphere, therefore, the impact on global warming would be 675 times higher than 1 kg of CO2, over a period of 100 years. Under no circumstances should the user try to intervene on the refrigerant circuit or disassemble the product. Always contact qualified personnel if necessary. 5. Home automation protocols available: KNX, Modbus, BACnet. The use of the SC-BIKN2-E interface card inhibits some functions of the unit. Contact your contact person for further details.

KIREIA Smart

WALL



OPTIONAL



<REMOTE CONTROL>
INCLUDED



SRC 25~35 ZSP-W



SRC 50 ZSP-W



Indoor unit model		SRK 25 ZSP-W		SRK 35 ZSP-W		SRK 50 ZSP-W	
Outdoor unit model		SRC 25 ZSP-W		SRC 35 ZSP-W		SRC 50 ZSP-W	
Type		DC-Inverter Heat pump					
Control (included)		Remote control					
Nominal data							
Rated capacity (T=+35°C)	Cooling	kW	2.50 (0.90~3.10)	3.20 (0.90~3.70)	5.00 (1.30~5.20)		
Rated power input (T=+35°C)		kW	0.71 (0.20~1.01)	0.91 (0.20~1.32)	1.76 (0.29~1.86)		
Rated energy efficiency coefficient		EER ¹	3.52	3.52	2.87		
Rated capacity (T=+7°C)	Heating	kW	2.80 (1.00~4.10)	3.60 (1.00~4.60)	5.60 (1.20~5.80)		
Rated power input (T=+7°C)		kW	0.69 (0.20~1.43)	0.93 (0.20~1.43)	1.66 (0.27~1.84)		
Rated energy performance coefficient		COP ¹	4.05	3.87	3.37		
Seasonal data							
Design load (Pdesignc)	Cooling	kW	2.50	3.20	5.00		
Seasonal energy efficiency index		SEER ²	6.80	7.30	6.20		
Seasonal energy efficiency class		626/2011 ³	A++	A++	A++		
Annual energy consumption		kWh/y	129	154	283		
Design load (Pdesignh) @ -10°C	Heating (average climate conditions)	kW	2.80	3.00	3.80		
Seasonal energy efficiency index		SCOP ²	4.10	4.40	4.20		
Seasonal energy efficiency class		626/2011 ³	A+	A+	A+		
Annual energy consumption		kWh/y	957	955	1269		
Electrical data							
Power supply	Outdoor unit	Ph-V-Hz	1Ph - 220/240V - 50Hz				
Power cable		Type	3 x 2.5 mm ²	3 x 2.5 mm ²	3 x 4 mm ²		
Wiring cables I.U./O.U.		nb.	4	4	4		
Nominal absorbed current	Cooling	A	3.40	4.30	7.60		
	Heating	A	3.40	4.30	7.30		
Max current	A	9.00	9.00	14.50			
Max power input	kW	1.65	1.65	2.68			
Refrigerant circuit data							
Refrigerant ⁴	Type (GWP)	R32 (675)					
Refrigerant precharge	Kg	0.55	0.68	1.10			
Tons of CO ₂ equivalent	t	0.371	0.459	0.743			
Diameter of refrigerant pipings liquid/gas	mm (inch.)	6.35(1/4") - 9.52(3/8")	6.35(1/4") - 9.52(3/8")	6.35(1/4") - 12.74(1/2")			
Max splitting distance	m	15	15	25			
Max splitting level difference I.U./O.U.	m	10	10	15			
Max. splitting without additional charge	m	10	15	15			
Additional charge	g/m	20	20	20			
Indoor unit specifications							
Dimensions	LxDxH	mm	783x210x267	783x210x267	783x210x267		
Net weight	Kg	7	7	7.5			
Sound power level	Max	dB(A)	57	58	63		
Sound pressure level (Hi/Me/Lo)	Cooling	dB(A)	45/34/23	45/36/23	46/39/24		
	Heating	dB(A)	43/34/26	44/36/28	48/41/30		
Air flow volume (Hi/Me/Lo)	Cooling	m ³ /h	600/438/252	570/408/252	594/432/228		
	Heating	m ³ /h	570/438/312	576/444/330	720/552/372		
Outdoor unit specifications							
Dimensions	LxDxH	mm	645(+57)x275x540	645(+57)x275x540	780(+62)x290x595		
Net weight	Kg	26.5	28.5	36			
Sound power level	Max	dB(A)	57	60	66		
Sound pressure level	Max	dB(A)	47	48	52		
Air flow volume	Max	m ³ /h	1422	1368	2262		
Operating range (outdoor temperature)	Cooling	°C	-15~46				
	Heating	°C	-15~24				
Optional parts							
Wi-Fi module	INWFIUNIO011000						
Interface for home automation connection and wired control	Not available for this product						

1. Value measured according to harmonised standard EN14511. 2. EU Regulation N.206/2012 - - Value measured according to harmonised standard EN14825. 3. Delegated Regulation UE N.626/2011 with regard to energy labelling indicating the energy consumption of air conditioners. 4. Refrigerant leakage contributes to climate change. When released into the atmosphere, refrigerants with a lower global warming potential (GWP) contribute less to global warming than those with a higher GWP. This appliance contains a refrigerant with a GWP of 675. If 1 kg of this refrigerant fluid were released into the atmosphere, therefore, the impact on global warming would be 675 times higher than 1 kg of CO₂ over a period of 100 years. Under no circumstances should the user try to intervene on the refrigerant circuit or disassemble the product. Always contact qualified personnel if necessary. 5. Home automation protocols available: KNX, Modbus, BACnet. The use of the SC-BKN2-E interface card inhibits some functions of the unit. Contact your contact person for further details.

KIREIA EVO

WALL



SRK 15~50 ZTL-W



<REMOTE CONTROL INCLUDED>

SRC 15 ZTL-W
SRC 20 ZTL-W
SRC 25 ZTL-W
SRC 35 ZTL-W

SRC 50 ZTL-W
*the "weekly timer" function can only be used from the WF-RAC application



Indoor unit model	SRK 15 ZTL-W		SRK 20 ZTL-W		SRK 25 ZTL-W		SRK 35 ZTL-W		SRK 50 ZTL-W	
Outdoor unit model	SRC 15 ZTL-W		SRC 20 ZTL-W		SRC 25 ZTL-W		SRC 35 ZTL-W		SRC 50 ZTL-W	
Type	DC-Inverter Heat pump									
Control (included)	Remote control									
Nominal data										
Rated capacity (T=+35°C)	Cooling	kW	1.50 (0.80~2.50)	2.00 (0.70~2.80)	2.50 (0.80~3.20)	3.50 (0.80~3.70)	5.00 (1.30~5.30)			
Rated power input (T=+35°C)		kW	0.35 (0.20~0.85)	0.51 (0.20~0.92)	0.58 (0.19~0.95)	1.05 (0.19~1.30)	1.59 (0.29~1.77)			
Rated energy efficiency coefficient		EER ¹	4.29	3.92	4.31	3.33	3.14			
Rated capacity (T=+7°C)	Heating	kW	2.00 (0.90~4.10)	2.70 (0.90~4.20)	3.00 (1.00~4.80)	3.80 (1.00~4.90)	5.80 (1.30~6.30)			
Rated power input (T=+7°C)		kW	0.42 (0.21~1.39)	0.64 (0.21~1.40)	0.66 (0.21~1.48)	0.90 (0.21~1.50)	1.62 (0.27~2.04)			
Rated energy performance coefficient		COP ¹	4.76	4.22	4.55	4.22	3.58			
Seasonal data										
Design load (Pdesignc)	Cooling	kW	1.50	2.00	2.50	3.50	5.00			
Seasonal energy efficiency index		SEER ²	6.40	6.70	6.90	6.50	6.50			
Seasonal energy efficiency class		626/2011 ³	A++	A++	A++	A++	A++			
Annual energy consumption		kWh/y	83	105	127	189	270			
Design load (Pdesignh) @ -10°C	Heating (average climate conditions)	kW	2.30	2.40	2.70	2.80	4.00			
Seasonal energy efficiency index		SCOP ²	4.40	4.40	4.70	4.70	4.30			
Seasonal energy efficiency class		626/2011 ³	A+	A+	A++	A++	A+			
Annual energy consumption		kWh/y	732	764	804	835	1302			
Electrical data										
Power supply	Outdoor unit	Ph-V-Hz	1Ph - 220/240V - 50Hz							
Power cable		Type	3 x 2.5 mm ²	3 x 2.5 mm ²	3 x 2.5 mm ²	3 x 2.5 mm ²	3 x 4 mm ²			
Wiring cables I.U./O.U.		nb.	4	4	4	4	4			
Nominal absorbed current	Cooling	A	2.00	2.90	3.20	4.90	7.00			
	Heating	A	2.40	3.50	3.60	4.30	7.10			
Max current		A	9.00	9.00	9.00	9.00	14.50			
Max power input		kW	1.53	1.53	1.63	1.65	2.24			
Refrigerant circuit data										
Refrigerant ⁴		Type (GWP)	R32 (675)							
Refrigerant precharge		Kg	0.43	0.43	0.59	0.59	0.90			
Tons of CO ₂ equivalent		t	0.290	0.290	0.398	0.398	0.606			
Diameter of refrigerant pipings liquid/gas		mm (inch.)	6.35(1/4") - 9.52(3/8")	6.35(1/4") - 9.52(3/8")	6.35(1/4") - 9.52(3/8")	6.35(1/4") - 9.52(3/8")	6.35(1/4") - 12.74(1/2")			
Max splitting distance		m	20	20	20	20	25			
Max splitting level difference I.U./O.U.		m	15	15	15	15	20			
Max. splitting without additional charge		m	10	10	10	10	15			
Additional charge		g/m	20	20	20	20	20			
Indoor unit specifications										
Dimensions	LxDxH	mm	798x210x294	798x210x294	798x210x294	798x210x294	798x210x294			
Net weight		Kg	8.5	8.5	9	9	9.5			
Sound power level	Max	dB(A)	53	54	55	57	60			
Sound pressure level (Hi/Me/Lo/ULo)	Cooling	dB(A)	36/30/23/19	37/31/23/19	41/36/26/22	42/37/27/22	47/40/32/25			
	Heating	dB(A)	38/32/24/19	39/34/25/19	41/36/29/22	43/37/31/22	47/40/33/25			
Air flow volume (Hi/Me/Lo/ULo)	Cooling	m ³ /h	570/450/294/228	594/468/294/228	600/480/318/264	624/510/330/264	750/624/432/324			
	Heating	m ³ /h	600/522/348/264	624/546/372/264	660/564/390/300	708/588/408/300	756/690/534/384			
Outdoor unit specifications										
Dimensions	LxDxH	mm	645(+57)x275x540	645(+57)x275x540	645(+57)x275x540	645(+57)x275x540	780(+62)x290x595			
Net weight		Kg	19.5	19.5	21.5	21.5	31.5			
Sound power level	Max	dB(A)	57	58	59	62	65			
Sound pressure level	Max	dB(A)	44	46	47	50	53			
Air flow volume	Max	m ³ /h	1776	1776	1302	1446	2028			
Operating range (outdoor temperature)	Cooling	°C	-15~46							
	Heating	°C	-15~24							
Optional parts										
Wi-Fi module			Included							
Interface for home automation connection and wired controls			SC-BIKN2-E							

1. Value measured according to harmonised standard EN14511. 2. EU Regulation N.206/2012 - - Value measured according to harmonised standard EN14825. 3. Delegated Regulation UE N.626/2011 with regard to energy labelling indicating the energy consumption of air conditioners. 4. Refrigerant leakage contributes to climate change. When released into the atmosphere, refrigerants with a lower global warming potential (GWP) contribute less to global warming than those with a higher GWP. This appliance contains a refrigerant with a GWP of 675. If 1 kg of this refrigerant fluid were released into the atmosphere, the impact on global warming would be 675 times higher than 1 kg of CO₂ over a period of 100 years. Under no circumstances should the user try to intervene on the refrigerant circuit or disassemble the product. Always contact qualified personnel if necessary. 5. Home automation protocols available: KNX, Modbus, BACnet. The use of the SC-BIKN2-E interface card inhibits some functions of the unit.

KIREIA EVO

WALL



SRK 63~71 ZTL-W

<INCLUDED>

<ALLERGEN CLEAR FILTER>

<REMOTE CONTROL INCLUDED>

SRC 63~71 ZTL-W



*the "weekly timer" function can only be used from the WF-RAC application

Indoor unit model		SRK 63 ZTL-W		SRK 71 ZTL-W	
Outdoor unit model		SRC 63 ZTL-W		SRC 71 ZTL-W	
Type		DC-Inverter Heat pump			
Control (included)		Remote control			
Nominal data					
Rated capacity (T=+35°C)	Cooling	kW	6.30 (1.20~7.10)	7.10 (1.20~7.30)	
Rated power input (T=+35°C)		kW	1.84 (0.27~2.43)	2.45 (0.28~2.67)	
Rated energy efficiency coefficient		EER ¹	3.42	2.90	
Rated capacity (T=+7°C)	Heating	kW	7.10 (1.00~8.50)	8.00 (1.10~9.10)	
Rated power input (T=+7°C)		kW	2.01 (0.25~2.89)	2.37 (0.26~3.30)	
Rated energy performance coefficient		COP ¹	3.53	3.38	
Seasonal data					
Design load (Pdesignc)	Cooling	kW	6.30	7.10	
Seasonal energy efficiency index		SEER ²	7.50	7.10	
Seasonal energy efficiency class		626/2011 ³	A++	A++	
Annual energy consumption		kWh/y	295	351	
Design load (Pdesignh) @ -10°C	Heating (average climate conditions)	kW	5.30	6.20	
Seasonal energy efficiency index		SCOP ²	4.60	4.40	
Seasonal energy efficiency class		626/2011 ³	A++	A+	
Annual energy consumption		kWh/y	1615	1972	
Electrical data					
Power supply	Outdoor unit	Ph-V-Hz	1Ph - 220/240V - 50Hz		
Power cable		Type	3 x 4 mm ²		3 x 4 mm ²
Wiring cables I.U./O.U.		nb.	4		4
Nominal absorbed current	Cooling	A	8.10		10.80
	Heating	A	8.80		10.40
Max current		A	17.00		17.00
Max power input		kW	3.18		3.63
Refrigerant circuit data					
Refrigerant ⁴		Type (GWP)	R32 (675)		
Refrigerant precharge		Kg	1.20		1.20
Tons of CO2 equivalent		t	0.810		0.810
Diameter of refrigerant pipings liquid/gas		mm (inch.)	6.35(1/4") - 12.74(1/2")		6.35(1/4") - 12.74(1/2")
Max splitting distance		m	30		30
Max splitting level difference I.U./O.U.		m	20		20
Max. splitting without additional charge		m	15		15
Additional charge		g/m	20		20
Indoor unit specifications					
Dimensions	LxDxH	mm	998x230x294		998x230x294
Net weight		Kg	12		12
Sound power level	Max	dB(A)	60		61
Sound pressure level (Hi/Me/Lo/ULo)	Cooling	dB(A)	46/43/38/30		48/44/39/31
	Heating	dB(A)	47/43/39/32		47/44/40/33
Air flow volume (Hi/Me/Lo/ULo)	Cooling	m ³ /h	1020/882/726/564		1050/912/756/564
	Heating	m ³ /h	1104/1032/846/696		1134/1062/876/696
Outdoor unit specifications					
Dimensions	LxDxH	mm	800(+71)x290x640		800(+71)x290x640
Net weight		Kg	42.5		42.5
Sound power level	Max	dB(A)	66		66
Sound pressure level	Max	dB(A)	54		54
Air flow volume	Max	m ³ /h	2580		2580
Operating range (outdoor temperature)	Cooling	°C	-15~46		
	Heating	°C	-15~24		
Optional parts					
Wi-Fi module			Included		
Interface for home automation connection and wired controls			SC-BIKN2-E		

1. Value measured according to harmonised standard EN14511. 2. EU Regulation N.206/2012 - - Value measured according to harmonised standard EN14825. 3. Delegated Regulation UE N.626/2011 with regard to energy labelling indicating the energy consumption of air conditioners. 4. Refrigerant leakage contributes to climate change. When released into the atmosphere, refrigerants with a lower global warming potential (GWP) contribute less to global warming than those with a higher GWP. This appliance contains a refrigerant with a GWP of 675. If 1 kg of this refrigerant fluid were released into the atmosphere, therefore, the impact on global warming would be 675 times higher than 1 kg of CO₂ over a period of 100 years. Under no circumstances should the user try to intervene on the refrigerant circuit or disassemble the product. Always contact qualified personnel if necessary. 5. Home automation protocols available: KNX, Modbus, BACnet. The use of the SC-BIKN2-E interface card inhibits some functions of the unit.

LARGE COMFORT

WALL



SRK 63~80 ZR-WF

<INCLUDED>

<ALLERGEN CLEAR FILTER>

<REMOTE CONTROL INCLUDED>

SRC 63 ZR-W SRC 71~80 ZR-W



Indoor unit model		SRK 63 ZR-WF		SRK 71 ZR-WF		SRK 80 ZR-WF	
Outdoor unit model		SRC 63 ZR-W		SRC 71 ZR-W		SRC 80 ZR-W	
Type		DC-Inverter Heat pump					
Control (included)		Remote control					
Nominal data							
Rated capacity (T=+35°C)	Cooling	kW	6.30 (1.20~7.40)	7.10 (2.30~7.80)	8.00 (2.30~9.70)		
Rated power input (T=+35°C)		kW	1.63 (0.20~2.50)	1.93 (0.48~2.40)	2.09 (0.48~3.20)		
Rated energy efficiency coefficient		EER ¹	3.89	3.68	3.83		
Rated capacity (T=+7°C)	Heating	kW	7.10 (0.80~9.30)	8.00 (2.00~10.80)	9.00 (2.10~11.20)		
Rated power input (T=+7°C)		kW	1.64 (0.16~2.80)	1.95 (0.40~3.60)	2.27 (0.40~3.50)		
Rated energy performance coefficient		COP ¹	4.33	4.10	3.96		
Seasonal data							
Design load (Pdesignc)	Cooling	kW	6.30	7.10	8.00		
Seasonal energy efficiency index		SEER ²	8.10	7.40	7.00		
Seasonal energy efficiency class		626/2011 ³	A++	A++	A++		
Annual energy consumption		kWh/y	273	337	401		
Design load (Pdesignh) @ -10°C	Heating (average climate conditions)	kW	5.40	6.60	7.10		
Seasonal energy efficiency index		SCOP ²	4.70	4.50	4.40		
Seasonal energy efficiency class		626/2011 ³	A++	A+	A+		
Annual energy consumption		kWh/y	1608	2055	2259		
Electrical data							
Power supply	Outdoor unit	Ph-V-Hz	1Ph - 220/240V - 50Hz				
Power cable		Type	3 x 4 mm ²	3 x 4 mm ²	3 x 4 mm ²		
Wiring cables I.U./O.U.		nb.	4	4	4		
Nominal absorbed current	Cooling	A	7.20	8.60	9.30		
	Heating	A	7.20	8.70	10.10		
Max current		A	14.50	17.00	17.00		
Max power input		kW	2.90	3.65	3.65		
Refrigerant circuit data							
Refrigerant ⁴		Type (GWP)	R32 (675)				
Refrigerant precharge		Kg	1.25	1.50	1.60		
Tons of CO2 equivalent		t	0.844	1.013	1.080		
Diameter of refrigerant pipings liquid/gas		mm (inch.)	6.35(1/4") - 12.74(1/2")	6.35(1/4") - 15.88(5/8")	6.35(1/4") - 15.88(5/8")		
Max splitting distance		m	30	30	30		
Max splitting level difference I.U./O.U.		m	20	20	20		
Max. splitting without additional charge		m	15	15	15		
Additional charge		g/m	20	25	25		
Indoor unit specifications							
Dimensions	LxDxH	mm	1197x262x339	1197x262x339	1197x262x339		
Net weight		Kg	15.5	15.5	16.5		
Sound power level	Max	dB(A)	58	60	62		
Sound pressure level (Hi/Me/Lo/ULo)	Cooling	dB(A)	44/39/35/25	44/41/37/25	47/44/39/26		
	Heating	dB(A)	44/38/34/28	46/39/35/28	47/41/36/29		
Air flow volume (Hi/Me/Lo/ULo)	Cooling	m ³ /h	1230/1086/942/624	1230/1116/972/624	1410/1212/1050/624		
	Heating	m ³ /h	1350/1140/990/786	1500/1188/1038/798	1590/1278/1104/810		
Outdoor unit specifications							
Dimensions	LxDxH	mm	800(+71)x290x640	880(+88)x340x750	880(+88)x340x750		
Net weight		Kg	45	56	57		
Sound power level	Max	dB(A)	65	63	67		
Sound pressure level	Max	dB(A)	54	53	56		
Air flow volume	Max	m ³ /h	2490	3300	3780		
Operating range (outdoor temperature)	Cooling	°C	-15~46				
	Heating	°C	-15~24				
Optional parts							
Wi-Fi module			Included				
Interface for home automation connection and wired controls			SC-BIKN2-E				

1. Value measured according to harmonised standard EN14511. 2. EU Regulation N.206/2012 - - Value measured according to harmonised standard EN14825. 3. Delegated Regulation UE N.626/2011 with regard to energy labelling indicating the energy consumption of air conditioners. 4. Refrigerant leakage contributes to climate change. When released into the atmosphere, refrigerants with a lower global warming potential (GWP) contribute less to global warming than those with a higher GWP. This appliance contains a refrigerant with a GWP of 675. If 1 kg of this refrigerant fluid were released into the atmosphere, therefore, the impact on global warming would be 675 times higher than 1 kg of CO2, over a period of 100 years. Under no circumstances should the user try to intervene on the refrigerant circuit or disassemble the product. Always contact qualified personnel if necessary. 5. Home automation protocols available: KNX, Modbus, BACnet. The use of the SC-BIKN2-E interface card inhibits some functions of the unit.

PRIMARY HEATING

CONSOLE



SRF 25~35 ZS-W / SRF 50 ZSX-W



OPTIONAL



<REMOTE CONTROL>
INCLUDED



SRC 25~35 ZS-W2



SRC 50 ZSX-W3



Indoor unit model		SRF 25 ZS-W		SRF 35 ZS-W		SRF 50 ZSX-W	
Outdoor unit model		SRC 25 ZS-W2		SRC 35 ZS-W2		SRC 50 ZSX-W3	
Type		DC-Inverter Heat pump					
Control (included)		Remote control					
Nominal data							
Rated capacity (T=+35°C)	Cooling	kW	2.50 (0.90~3.10)	3.50 (0.90~4.10)	5.00 (1.10~5.60)		
Rated power input (T=+35°C)		kW	0.59 (0.19~0.89)	0.82 (0.18~1.33)	1.32 (0.19~1.90)		
Rated energy efficiency coefficient		EER ¹	4.24	4.27	3.79		
Rated capacity (T=+7°C)	Heating	kW	2.90 (0.80~3.70)	4.50 (0.80~5.20)	6.00 (0.80~7.40)		
Rated power input (T=+7°C)		kW	0.66 (0.20~1.14)	1.12 (0.19~1.53)	1.58 (0.19~2.34)		
Rated energy performance coefficient		COP ¹	4.39	4.02	3.80		
Seasonal data							
Design load (Pdesignc)	Cooling	kW	2.50	3.50	5.00		
Indice di efficienza energetica stagionale		SEER ²	7.40	8.10	7.50		
Seasonal energy efficiency class		626/2011 ³	A++	A++	A++		
Annual energy consumption		kWh/y	119	152	234		
Design load (Pdesignh) @ -10°C	Heating (average climate conditions)	kW	2.40	2.90	4.10		
Seasonal energy efficiency index		SCOP ²	4.00	4.70	4.60		
Seasonal energy efficiency class		626/2011 ³	A+	A++	A++		
Annual energy consumption		kWh/y	840	864	1247		
Electrical data							
Power supply	Outdoor unit	Ph-V-Hz	1Ph - 220/240V - 50Hz				
Power cable		Type	3 x 2.5 mm ²	3 x 2.5 mm ²	3 x 4 mm ²		
Wiring cables I.U./O.U.		nb.	4	4	4		
Nominal absorbed current	Cooling	A	3.00	3.90	5.80		
	Heating	A	3.30	5.10	6.90		
Max current		A	9.00	9.00	15.00		
Max power input		kW	1.65	1.65	2.90		
Refrigerant circuit data							
Refrigerant ⁴		Type (GWP)	R32 (675)				
Refrigerant precharge		Kg	0.62	0.78	1.3		
Tons of CO ₂ equivalent		t	0.419	0.527	0.878		
Diameter of refrigerant pipings liquid/gas		mm (inch.)	6.35(1/4") - 9.52(3/8")	6.35(1/4") - 9.52(3/8")	6.35(1/4") - 12.74(1/2")		
Max splitting distance		m	20	20	30		
Max splitting level difference I.U./O.U.		m	10	10	20		
Max. splitting without additional charge		m	10	15	15		
Additional charge		g/m	20	20	20		
Indoor unit specifications							
Dimensions	LxDxH	mm	860x238x600	860x238x600	860x238x600		
Net weight		Kg	18	19	19		
Sound power level	Max	dB(A)	51	52	58		
Sound pressure level (Hi/Me/Lo/Ulo)	Cooling	dB(A)	38/32/29/25	40/35/33/29	46/38/33/28		
	Heating	dB(A)	39/35/33/39	41/36/35/33	46/41/38/32		
Air flow volume (Hi/Me/Lo/Ulo)	Cooling	m ³ /h	540/456/402/348	552/468/438/384	690/576/444/396		
	Heating	m ³ /h	630/492/462/396	642/498/486/444	720/600/564/456		
Outdoor unit specifications							
Dimensions	LxDxH	mm	780(+62)x290x540	780(+62)x290x540	800(+71)x290x640		
Net weight		Kg	31	34.5	45		
Sound power level	Max	dB(A)	60	64	63		
Sound pressure level	Max	dB(A)	47	51	51		
Air flow volume	Max	m ³ /h	1644	1890	2340		
Operating range (outdoor temperature)	Cooling	°C	-15~46				
	Heating	°C	-15~24				
Optional parts							
Wi-Fi module			WF-RAC				
Interface for home automation connection and wired controls			SC-BIKN2-E				

1. Value measured according to harmonised standard EN14511. 2. EU Regulation N.206/2012 - - Value measured according to harmonised standard EN14825. 3. Delegated Regulation UE N.626/2011 with regard to energy labelling indicating the energy consumption of air conditioners. 4. Refrigerant leakage contributes to climate change. When released into the atmosphere, refrigerants with a lower global warming potential (GWP) contribute less to global warming than those with a higher GWP. This appliance contains a refrigerant with a GWP of 675. If 1 kg of this refrigerant fluid were released into the atmosphere, therefore, the impact on global warming would be 675 times higher than 1 kg of CO₂ over a period of 100 years. Under no circumstances should the user try to intervene on the refrigerant circuit or disassemble the product. Always contact qualified personnel if necessary. 5. Home automation protocols available: KNX, Modbus, BACnet. The use of the SC-BIKN2-E interface card inhibits some functions of the unit.

LIGHT COMMERCIAL

DUCTED LOW STATIC PRESSURE



SRR 25-35-50-60 ZS-W



OPTIONAL



<REMOTE CONTROL>
INCLUDED



SRC 25-35 ZS-W2



SRC 50-60 ZSX-W3



Indoor unit model		SRR 25 ZS-W	SRR 35 ZS-W	SRR 50 ZS-W	SRR 60 ZS-W	
Outdoor unit model		SRC 25 ZS-W2	SRC 35 ZS-W2	SRC 50 ZSX-W3	SRC 60 ZSX-W3	
Type		DC-Inverter Heat pump				
Control (included)		Remote control				
Nominal data						
Rated capacity (T=+35°C)	Cooling	kW	2.50 (0.90~3.20)	3.50 (0.90~4.10)	5.00 (1.20~6.00)	5.60 (1.20~6.50)
		kW	0.62 (0.19~0.99)	0.93 (0.19~1.26)	1.42 (0.22~2.02)	1.70 (0.22~2.57)
		EER ¹	4.03	3.76	3.52	3.29
Rated capacity (T=+7°C)	Heating	kW	2.90 (0.90~4.40)	4.20 (1.00~5.20)	5.40 (1.00~8.20)	6.70 (1.00~8.60)
		kW	0.65 (0.19~1.32)	1.01 (0.20~1.45)	1.39 (0.20~2.86)	1.89 (0.20~2.89)
		COP ¹	4.46	4.16	3.88	3.54
Seasonal data						
Design load (Pdesignc)	Cooling	kW	2.50	3.50	5.00	5.60
		SEER ²	6.60	6.80	6.50	6.20
		626/2011 ³	A++	A++	A++	A++
Annual energy consumption	Heating (average climate conditions)	kWh/y	133	181	270	316
		kW	2.50	3.10	4.50	5.20
		SCOP ²	4.10	4.50	4.40	4.30
Design load (Pdesignh) @ -10°C	Heating (average climate conditions)	kWh/y	853	966	1431	1692
		626/2011 ³	A+	A+	A+	A+
		kWh/y	853	966	1431	1692
Electrical data						
Power supply	Outdoor unit	Ph-V-Hz	1Ph - 220/240V - 50Hz			
Power cable		Type	3 x 2.5 mm ²	3 x 2.5 mm ²	3 x 4 mm ²	3 x 4 mm ²
Wiring cables I.U./O.U.		nb.	4	4	4	4
Nominal absorbed current	Cooling	A	3.10	4.30	6.20	7.50
	Heating	A	3.20	4.70	6.10	8.30
Max current		A	9.00	9.00	15.00	15.00
Max power input		kW	1.65	1.65	2.90	2.90
Refrigerant circuit data						
Refrigerant ⁴	Type (GWP)	R32 (675)				
Refrigerant precharge	Kg	0.62	0.78	1.3	1.3	
Tons of CO ₂ equivalent	t	0.419	0.527	0.878	0.878	
Diameter of refrigerant pipings liquid/gas	mm (inch.)	6.35(1/4") - 9.52(3/8")	6.35(1/4") - 9.52(3/8")	6.35(1/4") - 12.74(1/2")	6.35(1/4") - 12.74(1/2")	
Splitting distance	Min / Max	m	- / 20	3 / 30	3 / 30	
Max splitting level difference I.U./O.U.	m		10	20	20	
Max. splitting without additional charge	m		15	15	15	
Additional charge	g/m		20	20	20	
Indoor unit specifications						
Dimensions	LxDxH	mm	750x500x200	750x500x200	950x500x200	950x500x200
Net weight		Kg	20.5	20.5	24	24
Sound power level	Max	dB(A)	59	60	61	63
Sound pressure level (Hi/Me/Lo/U/Lo)	Cooling	dB(A)	37/33/30/24	38/34/31/25	41/37/34/29	44/38/35/30
	Heating	dB(A)	40/37/34/28	42/38/35/29	43/39/37/32	45/41/38/33
Air flow volume (Hi/Me/Lo/U/Lo)	Cooling	m ³ /h	570/480/390/270	600/510/420/300	810/660/600/450	870/690/630/480
	Heating	m ³ /h	600/540/480/360	630/570/510/390	840/750/660/510	900/780/690/540
Fan static pressure	Std/Max	Pa	5/35	5/35	5/50	5/50
Outdoor unit specifications						
Dimensions	LxDxH	mm	780(+62)x290x540	780(+62)x290x540	800(+71)x290x640	800(+71)x290x640
Net weight		Kg	31	34.5	45	45
Sound power level	Max	dB(A)	58	62	63	65
Sound pressure level	Max	dB(A)	47	50	51	53
Air flow volume	Max	m ³ /h	1644	1890	2340	2490
Operating range (outdoor temperature)	Cooling	°C	-15~46			
	Heating	°C	-15~24			
Optional parts						
Wi-Fi module ⁵				WF-RAC		
Interface for home automation connection and wired control ⁶				SC-BIKN2-E		
Kit for recovery from bottom			UT-BAT1EF		UT-BAT2EF	

1. Value measured according to harmonised standard EN14511. 2. EU Regulation N.206/2012 - - Value measured according to harmonised standard EN14825. 3. Delegated Regulation UE N.626/2011 with regard to energy labelling indicating the energy consumption of air conditioners. 4. Refrigerant leakage contributes to climate change. When released into the atmosphere, refrigerants with a lower global warming potential (GWP) contribute less to global warming than those with a higher GWP. This appliance contains a refrigerant with a GWP of 675. If 1 kg of this refrigerant fluid were released into the atmosphere, therefore, the impact on global warming would be 675 times higher than 1 kg of CO₂ over a period of 100 years. Under no circumstances should the user try to intervene on the refrigerant circuit or disassemble the product. Always contact qualified personnel if necessary. 5. The use of the Wi-Fi module excludes the possibility of connecting any other optional accessory. 6. Home automation protocols available: KNX, Modbus, BACnet.

LIGHT COMMERCIAL

DUCTED MEDIUM STATIC PRESSURE



FDUM 40~50 VH

FDUM 60 VH



OPTIONAL



RCN-KIT4-E2
Optional kit



SRC 40 ZSX-W1
SRC 50~60 ZSX-W3



*optional

Compatible with **AIRZONE** systems

Indoor unit model		FDUM 40 VH	FDUM 50 VH	FDUM 60 VH	
Outdoor unit model		SRC 40 ZSX-W1	SRC 50 ZSX-W3	SRC 60 ZSX-W3	
Type		DC-Inverter Heat pump			
Nominal data					
Rated capacity (T=+35°C)	Cooling	kW	4.00 (1.10~4.70)	5.00 (1.10~5.60)	5.60 (1.10~6.30)
Rated power input (T=+35°C)		kW	1.10	1.51	1.54
Rated energy efficiency coefficient		EER ¹	3.62	3.31	3.64
Rated capacity (T=+7°C)	Heating	kW	4.50 (0.60~5.40)	5.40 (0.60~6.30)	6.70 (0.60~7.10)
Rated power input (T=+7°C)		kW	1.10	1.59	1.75
Rated energy performance coefficient		COP ¹	4.09	3.39	3.83
Seasonal data					
Design load (Pdesignc)	Cooling	kW	4.00	5.00	5.60
Seasonal energy efficiency index		SEER ²	6.11	5.82	6.43
Seasonal energy efficiency class		626/2011 ³	A++	A+	A++
Annual energy consumption		kWh/y	230	301	305
Design load (Pdesignh) @ -10°C	Heating (average climate conditions)	kW	3.00	3.70	4.70
Seasonal energy efficiency index		SCOP ²	3.81	3.89	4.37
Seasonal energy efficiency class		626/2011 ³	A	A	A+
Annual energy consumption		kWh/y	1102	1332	1508
Electrical data					
Power supply	Outdoor unit	Ph-V-Hz	1-220~240V-50Hz		
Power cable		Type	3 x 4 mm ²	3 x 4 mm ²	3 x 4 mm ²
Wiring cables I.U./O.U.		nb.	4	4	4
Nominal absorbed current	Cooling	A	5.10	6.90	6.80
	Heating	A	5.00	7.20	7.80
Max current		A	15.00	15.00	15.00
Max power input		kW	2.60	2.90	2.90
Refrigerant circuit data					
Refrigerant ⁴		Type (GWP)	R32 (675)		
Refrigerant precharge		Kg	1.30	1.30	1.30
Tons of CO ₂ equivalent		t	0.878	0.878	0.878
Diameter of refrigerant pipings liquid/gas		mm (inch.)	6.35(1/4") - 12.74(1/2")	6.35(1/4") - 12.74(1/2")	6.35(1/4") - 12.74(1/2")
Max splitting distance		m	30	30	30
Max splitting level difference I.U./O.U.		m	20	20	20
Max. splitting without additional charge		m	15	15	15
Additional charge		g/m	20	20	20
Indoor unit specifications					
Dimensions	LxDxH	mm	750x635x280	750x635x280	950x635x280
Net weight		Kg	29	29	34
Sound power level	Max	dB(A)	60	60	60
Sound pressure level	P-Hi/Hi/Me/Lo	dB(A)	37/32/29/26	37/32/29/26	36/31/28/25
Air flow volume	P-Hi/Hi/Me/Lo	m ³ /h	780/600/540/480	780/600/540/480	1200/900/780/600
Fan static pressure	Std/Max	Pa	35/100	35/100	35/100
Outdoor unit specifications					
Dimensions	LxDxH	mm	800(+71)x290x640	800(+71)x290x640	800(+71)x290x640
Net weight		Kg	45	45	45
Sound power level	Max	dB(A)	63	63	65
Sound pressure level	Max	dB(A)	52	51	53
Air flow volume	Max	m ³ /h	1980	2340	2490
Operating range (outdoor temperature)	Cooling	°C	-15~+46		
	Heating	°C	-20~+20		
Accessories					
Wired control			RC-E5 (LCD) / RC-EX3A (touch) / RCH-E3 (simplified)		
IR remote control (KIT)			RCN-KIT4-E2		
Optional parts					
Wi-Fi module			INWFIMH1001R100		
Human sensor (KIT)			LB-KIT2		
SUPERLINK interface II			SC-ADNA-E		
Filtro ripresa (KIT)			UM-FL1EF		UM-FL2EF

1. Value measured according to harmonised standard EN14511. 2. EU Regulation N.206/2012 - - Value measured according to harmonised standard EN14825. 3. Delegated Regulation UE N.626/2011 with regard to energy labelling indicating the energy consumption of air conditioners. 4. Refrigerant leakage contributes to climate change. When released into the atmosphere, refrigerants with a lower global warming potential (GWP) contribute less to global warming than those with a higher GWP. This appliance contains a refrigerant with a GWP of 675. If 1 kg of this refrigerant fluid were released into the atmosphere, therefore, the impact on global warming would be 675 times higher than 1 kg of CO₂, over a period of 100 years. Under no circumstances should the user try to intervene on the refrigerant circuit or disassemble the product. Always contact qualified personnel if necessary.

LIGHT COMMERCIAL

CEILING

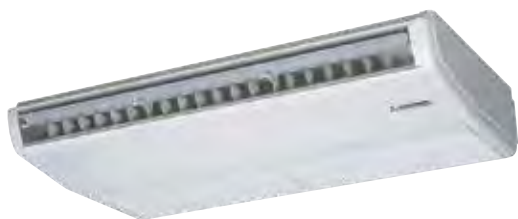

FDE 40~60 VH



OPTIONAL



RCN-E-E3
Optional kit



SRC 40 ZSX-W1
SRC 50~60 ZSX-W3



*optional

Indoor unit model		FDE 40 VH		FDE 50 VH		FDE 60 VH	
Outdoor unit model		SRC 40 ZSX-W1		SRC 50 ZSX-W3		SRC 60 ZSX-W3	
Type		DC-Inverter Heat pump					
Nominal data							
Rated capacity (T=+35°C)	Cooling	kW	4.00 (1.10~4.70)	5.00 (1.10~4.70)	5.60 (1.10~6.30)		
		kW	1.02	1.43	1.51		
		EER ¹	3.92	3.49	3.71		
Rated capacity (T=+7°C)	Heating	kW	4.50 (0.60~5.40)	5.40 (0.60~5.40)	6.70 (0.60~7.10)		
		kW	1.10	1.46	1.86		
		COP ¹	4.09	3.70	3.60		
Seasonal data							
Design load (Pdesignc)	Cooling	kW	4.00	5.00	5.60		
		SEER ²	A++	A++	A++		
		626/2011 ³	6.46	6.15	6.72		
Annual energy consumption		kWh/y	217	285	292		
Design load (Pdesignh) @ -10°C	Heating (average climate conditions)	kW	3.00	3.80	4.50		
		SCOP ²	4.02	4.07	4.41		
		626/2011 ³	A+	A+	A+		
Annual energy consumption		kWh/y	1045	1307	1430		
Electrical data							
Power supply	Outdoor unit	Ph-V-Hz	1-220~240V-50Hz				
Power cable		Type	3 x 4 mm ²	3 x 4 mm ²	3 x 4 mm ²		
Wiring cables I.U./O.U.		nb.	4	4	4		
Nominal absorbed current	Cooling	A	4.80	6.60	6.90		
	Heating	A	5.10	7.00	8.70		
Max current		A	15.00	15.00	15.00		
Max power input		kW	2.60	2.90	2.90		
Refrigerant circuit data							
Refrigerant ⁴	Type (GWP)	R32 (675)					
Refrigerant precharge	Kg	1.30	1.30	1.30			
Tons of CO ₂ equivalent	t	0.878	0.878	0.878			
Diameter of refrigerant pipings liquid/gas	mm (inch.)	6.35(1/4") - 12.74(1/2")	6.35(1/4") - 12.74(1/2")	6.35(1/4") - 12.74(1/2")			
Max splitting distance	m	30	30	30			
Max splitting level difference I.U./O.U.	m	20	20	20			
Max. splitting without additional charge	m	15	15	15			
Additional charge	g/m	20	20	20			
Indoor unit specifications							
Dimensions	LxDxH	mm	1070x690x210	1070x690x210	1320x690x210		
Net weight		Kg	28	28	33		
Sound power level	Max	dB(A)	60	60	60		
Sound pressure level	P-Hi/Hi/Me/Lo	dB(A)	46/38/36/31	46/38/36/31	47/41/37/32		
Air flow volume	P-Hi/Hi/Me/Lo	m ³ /h	780/600/540/420	780/600/540/420	1200/960/780/600		
Outdoor unit specifications							
Dimensions	LxDxH	mm	800(+71)x290x640	800(+71)x290x640	800(+71)x290x640		
Net weight		Kg	45	45	45		
Sound power level	Max	dB(A)	63	63	65		
Sound pressure level	Max	dB(A)	52	51	53		
Air flow volume	Max	m ³ /h	1980	2340	2490		
Operating range (outdoor temperature)	Cooling	°C	-15~+46				
	Heating	°C	-20~+20	-15~24			
Accessories							
Wired control	RC-E5 (LCD) / RC-EX3A (touch) / RCH-E3 (simplified)						
IR remote control (KIT)	RCN-E-E3						
Optional parts							
Wi-Fi module	INWFIMHI001R100						
Human sensor (KIT)	LB-E						
SUPERLINK interface II	SC-ADNA-E						

1. Value measured according to harmonised standard EN14511. 2. EU Regulation N.206/2012 -- Value measured according to harmonised standard EN14825. 3. Delegated Regulation UE N.626/2011 with regard to energy labelling indicating the energy consumption of air conditioners. 4. Refrigerant leakage contributes to climate change. When released into the atmosphere, refrigerants with a lower global warming potential (GWP) contribute less to global warming than those with a higher GWP. This appliance contains a refrigerant with a GWP of 675. If 1 kg of this refrigerant fluid were released into the atmosphere, therefore, the impact on global warming would be 675 times higher than 1 kg of CO₂, over a period of 100 years. Under no circumstances should the user try to intervene on the refrigerant circuit or disassemble the product. Always contact qualified personnel if necessary.

FDTCE FDT CASSETTE

Anti-draft panel (optional)

Flexible flap control to prevent direct currents.

4 extra flaps, individually controlled in each operating mode: they change the direction of the air flow and prevent the unpleasant sensation of direct currents.

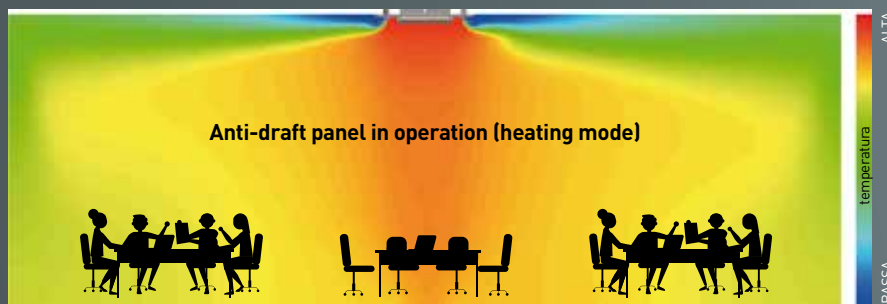
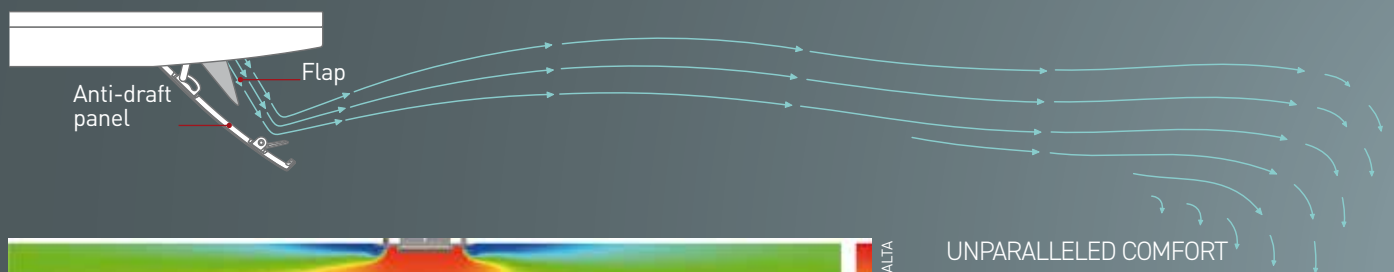

UNPARALLELED COMFORT

The anti-draft panel ensures a uniform air flow and a comfortable temperature in the room, both in cooling and in heating: it can be controlled to instantly eliminate any air currents that are too cold or too hot.

Furthermore, the panel helps the unit to aim the air flow for correct and uniform diffusion in the room.

The additional flaps are closed when the unit is not running.



Individual control of the four flaps (standard and anti-draft panels)

The flap control system lets you direct the air flow as needed

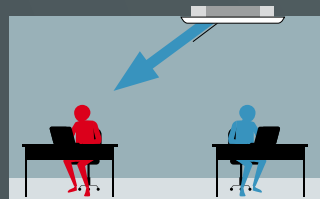

To reach people further away from the unit.



To reach only people who are feeling too hot or too cold.

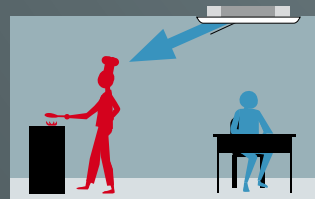

To reach the warmest parts of the room.

NOTE

The flaps cannot be controlled individually using the IR remote control.

FDTC CASSETTE 60x60

Ultra-compact design

FDTC weighs just 14 kg. The height of the thin panel and the main body is just 248 mm, allowing for very simple installation.

Measurements reduced to 620 mm, ideal for application in European modular ceilings.

JUST 10 MM THICK

The FDTC panel perfectly adheres to the ceiling because it only protrudes 10 mm.

HONEYCOMB GRILLE

VERY COMPACT DESIGN

The panel dimensions adapt perfectly to European modular ceiling lattices.

700 mm → 620 mm
previous model new model

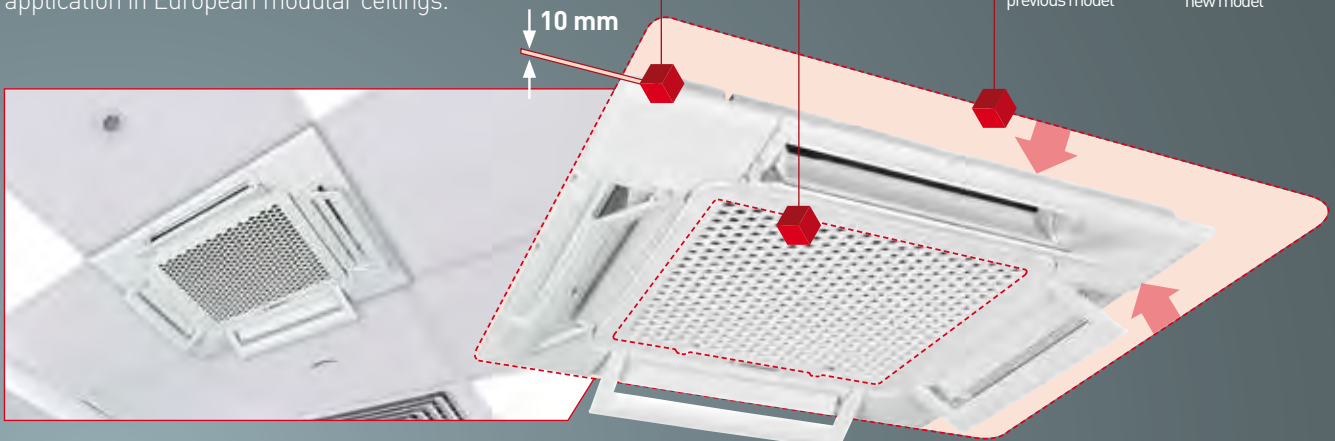

Standard linear and honeycomb panels



Standard linear panel

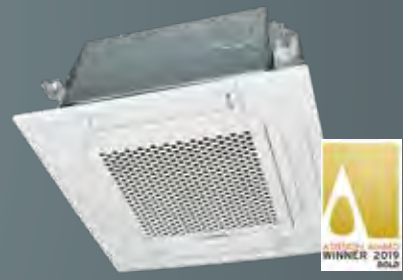

Standard honeycomb panel

FDT CASSETTE 84x84

Black and white colors of the standard and anti-draft panels, to expand the design possibilities in shops, offices and restaurants.



Anti-draft white panel

Standard black panel

LIGHT COMMERCIAL

CASSETTE 60X60



OPTIONAL



FDTC 25-35 VH1/FDTC 40-60 VH
Standard honeycomb panel
TC-PSA-5AW-E

FDTC 25-35 VH1/FDTC 40-60 VH
Anti-draft honeycomb panel
TC-PSAE-5AW-E

FDTC 25-35 VH1/FDTC 40-60 VH
Standard linear panel
TC-PSAG-5AW-E

FDTC 25-35 VH1/FDTC 40-60 VH
Anti-draft linear panel
TC-PSAGE-5AW-E



*optional

Indoor unit model	FDTC 25 VH1	FDTC 35 VH1	FDTC 40 VH	FDTC 50 VH	FDTC 60 VH	
Outdoor unit model	SRC 25 ZS-W2	SRC 35 ZS-W2	SRC 40 ZSX-W1	SRC 50 ZSX-W3	SRC 60 ZSX-W3	
Type	DC-Inverter Heat pump					
Nominal data						
Rated capacity (T=+35°C)	kW	2.50 (0.90~3.20)	3.50 (0.90~4.30)	4.00 (1.10~4.70)	5.00 (1.10~5.60)	5.60 (1.10~6.30)
Rated power input (T=+35°C)	Cooling kW	0.61 (0.18~0.98)	0.91 (0.18~1.37)	0.98	1.40	1.73
Rated energy efficiency coefficient	EER ¹	4.10	3.85	4.08	3.58	3.23
Rated capacity (T=+7°C)	Heating kW	2.90 (0.90~4.00)	4.25 (0.90~5.60)	4.50 (0.60~5.40)	5.40 (0.60~6.30)	6.70 (0.60~6.70)
Rated power input (T=+7°C)	Heating kW	0.71 (0.19~1.31)	1.15 (0.19~1.33)	1.13	1.53	2.14
Rated energy performance coefficient	COP ¹	4.08	3.70	3.98	3.53	3.13
Seasonal data						
Design load (Pdesignc)	kW	2.50	3.50	4.00	5.00	5.60
Seasonal energy efficiency index	SEER ²	6.80	7.10	6.94	6.52	6.45
Seasonal energy efficiency class	626/2011 ³	A++	A++	A++	A++	A++
Annual energy consumption	kWh/y	129	173	202	269	304
Design load (Pdesignh) @ -10°C	kW	2.40	2.90	4.00	4.30	5.10
Seasonal energy efficiency index	SCOP ²	4.00	4.60	4.37	4.30	4.10
Seasonal energy efficiency class	626/2011 ³	A+	A++	A+	A+	A+
Annual energy consumption	kWh/y	840	883	1283	1401	1744
Electrical data						
Power supply	Outdoor unit	Ph-V-Hz	1-220~240V-50Hz			
Power cable	Type	3 x 2.5 mm ²	3 x 2.5 mm ²	3 x 4 mm ²	3 x 4 mm ²	
Wiring cables I.U./O.U.	nb.	4	4	4	4	
Nominal absorbed current	Cooling	A	3.10	4.30	4.30	6.20
	Heating	A	3.40	5.30	5.00	6.70
Max current	A	9.00	9.00	15.00	15.00	15.00
Max power input	kW	1.65	1.65	2.60	2.90	2.90
Refrigerant circuit data						
Refrigerant ⁴	Type (GWP)	R32 (675)				
Refrigerant precharge	Kg	0.62	0.78	1.30	1.30	1.30
Tons of CO ₂ equivalent	t	0.419	0.527	0.878	0.878	0.878
Diameter of refrigerant pipings liquid/gas	mm (inch.)	6.35(1/4") - 9.52(3/8")	6.35(1/4") - 9.52(3/8")	6.35(1/4") - 12.74(1/2")	6.35(1/4") - 12.74(1/2")	6.35(1/4") - 12.74(1/2")
Max splitting distance	m	20	20	30	30	30
Max splitting level difference I.U./O.U.	m	10	10	20	20	20
Max. splitting without additional charge	m	15	15	15	15	15
Additional charge	g/m	20	20	20	20	20
Indoor unit specifications						
Dimensions	LxDxH	mm	570x570x248	570x570x248	570x570x248	
Net weight	Kg	13.5	13.5	14	14	
Sound power level	Max	dB(A)	52	53	59	
Sound pressure level	P-Hi/Hi/Me/Lo	dB(A)	39/36/32/28	41/38/34/30	44/40/35/27	
Air flow volume (P-Hi/Hi/Me/Lo)	Cooling	m ³ /h	510/450/420/360	540/480/450/390	780/660/540/420	
	Heating	m ³ /h	570/510/450/390	600/540/480/420	780/660/540/420	
Outdoor unit specifications						
Dimensions	LxDxH	mm	780(+62)x290x540	780(+62)x290x540	800(+71)x290x640	
Net weight	Kg	31	34.5	45	45	
Sound power level	Max	dB(A)	59	62	63	
Sound pressure level	Max	dB(A)	47	50	52	
Air flow volume	Max	m ³ /h	1644	1890	1980	
Operating range (outdoor temperature)	Cooling	°C	-15~+46	-15~+46	-15~+46	
	Heating	°C	-15~24	-15~24	-20~+20	
Accessories						
Decorative panel			TC-PSA-5AW-E (honeycomb) / TC-PSAG-5AW-E (linear)			
Panel size	LxDxH	mm	620x620x10	620x620x10	620x620x10	
Net weight	Kg	2.5	2.5	2.5	2.5	
Wired control	RC-E5 (LCD) / RC-EX3A (touch) / RCH-E3 (simplified)					
IR remote control (corner KIT)	RCN-TC-5AW-E3					
Optional parts						
Wi-Fi module	INWFIMHI001R100					
Human sensor (corner KIT)	LB-TC-5W-E					
SUPERLINK interface II	SC-ADNA-E					
Anti-draft panel	TC-PSAE-5AW-E (honeycomb) / TC-PSAGE-5AW-E (linear)					

1. Value measured according to harmonised standard EN14511. 2. EU Regulation N.206/2012 -- Value measured according to harmonised standard EN14825. 3. Delegated Regulation UE N.626/2011 with regard to energy labelling indicating the energy consumption of air conditioners. 4. Refrigerant leakage contributes to climate change. When released into the atmosphere, refrigerants with a lower global warming potential (GWP) contribute less to global warming than those with a higher GWP. This appliance contains a refrigerant with a GWP of 675. If 1 kg of this refrigerant fluid were released into the atmosphere, therefore, the impact on global warming would be 675 times higher than 1 kg of CO₂, over a period of 100 years. Under no circumstances should the user try to intervene on the refrigerant circuit or disassemble the product. Always contact qualified personnel if necessary.

LIGHT COMMERCIAL

CASSETTE 84X84



FDT 40~60 VH
Standard white panel
T-PSA-5BW-E

FDT 40~60 VH
Anti-draft white panel
T-PSAE-5BW-E

FDT 40~60 VH
Standard black panel
T-PSA-5BB-E

FDT 40~60 VH
Anti-draft black panel
T-PSAE-5BB-E



















*optional

Indoor unit model		FDT 40 VH		FDT 50 VH		FDT 60 VH	
Outdoor unit model		SRC 40 ZSX-W1		SRC 50 ZSX-W3		SRC 60 ZSX-W3	
Type		DC-Inverter Heat pump					
Nominal data							
Rated capacity (T=+35°C)	Cooling	kW	4.00 (1.10~4.70)	5.00 (1.10~5.60)	5.60 (1.10~6.30)		
		kW	0.89	1.29	1.33		
		EER ¹	4.49	3.88	4.21		
Rated capacity (T=+7°C)	Heating	kW	4.5 (0.6~5.4)	5.4 (0.6~6.3)	6.70 (0.60~6.70)		
		kW	1.03	1.31	1.56		
		COP ¹	4.37	4.12	4.29		
Seasonal data							
Design load (Pdesignc)	Cooling	kW	4.00	5.00	5.60		
		SEER ²	8.63	7.93	8.74		
		626/2011 ³	A+++	A++	A+++		
Annual energy consumption	Heating (average climate conditions)	kWh/y	163	221	225		
		kW	3.90	4.00	5.20		
		SCOP ²	4.62	4.63	5.00		
Design load (Pdesignh) @ -10°C	Heating (average climate conditions)	626/2011 ³	A++	A++	A++		
		kWh/y	1167	1210	1455		
		kWh/y	1167	1210	1455		
Electrical data							
Power supply	Outdoor unit	Ph-V-Hz	1-220~240V-50Hz				
Power cable		Type	3 x 4 mm ²	3 x 4 mm ²	3 x 4 mm ²		
Wiring cables I.U./O.U.		nb.	4	4	4		
Nominal absorbed current	Cooling	A	4.00	5.80	5.90		
	Heating	A	4.60	5.90	6.90		
Max current		A	15.00	15.00	15.00		
Max power input		kW	2.60	2.90	2.90		
Refrigerant circuit data							
Refrigerant ⁴		Type (GWP)	R32 (675)				
Refrigerant precharge		Kg	1.30	1.30	1.30		
Tons of CO ₂ equivalent		t	0.878	0.878	0.878		
Diameter of refrigerant pipings liquid/gas		mm (inch.)	6.35(1/4") - 12.74(1/2")	6.35(1/4") - 12.74(1/2")	6.35(1/4") - 12.74(1/2")		
Max splitting distance		m	30	30	30		
Max splitting level difference I.U./O.U.		m	20	20	20		
Max. splitting without additional charge		m	15	15	15		
Additional charge		g/m	20	20	20		
Indoor unit specifications							
Dimensions	LxDxH	mm	840X840X236	840X840X236	840X840X236		
Net weight		Kg	19	19	21		
Sound power level	Max	dB(A)	50	56	59		
Sound pressure level (P-Hi/Hi/Me/Lo)	Cooling	dB(A)	36/33/30/26	41/33/30/26	44/34/30/27		
	Heating	dB(A)	36/33/28/20	42/33/28/20	44/34/30/23		
Air flow volume	P-Hi/Hi/Me/Lo	m ³ /h	1140/960/780/600	1320/960/780/600	1560/1020/840/660		
Outdoor unit specifications							
Dimensions	LxDxH	mm	800(+71)x290x640	800(+71)x290x640	800(+71)x290x640		
Net weight		Kg	45	45	45		
Sound power level	Max	dB(A)	63	63	65		
Sound pressure level	Max	dB(A)	52	51	53		
Air flow volume	Max	m ³ /h	1980	2340	2490		
Operating range (outdoor temperature)	Cooling	°C	-15~+46	-15~+46	-15~+46		
	Heating	°C	-20~+20	-15~24	-15~24		
Accessories							
Decorative panel			T-PSA-5BW-E (white) / T-PSA-5BB-E (black)				
Panel size	LxDxH	mm	950x950x35	950x950x35	950x950x35		
Net weight		Kg	5	5	5		
Wired control	RC-E5 (LCD) / RC-EX3A (touch) / RCH-E3 (simplified)						
IR remote control (corner KIT)	RCN-T-5BW-E2 (white) / RCN-T-5BB-E2 (black)						
Optional parts							
Wi-Fi module	INWFIMH1001R100						
Human sensor (corner KIT)	LB-T-5BW-E (white) / LB-T-5BB-E (black)						
SUPERLINK interface II	SC-ADNA-E						
Anti-draft panel	T-PSAE-5BW-E (white) / T-PSAE-5BB-E (black)						

1. Value measured according to harmonised standard EN14511. 2. EU Regulation N.206/2012 -- Value measured according to harmonised standard EN14825. 3. Delegated Regulation UE N.626/2011 with regard to energy labelling indicating the energy consumption of air conditioners. 4. Refrigerant leakage contributes to climate change. When released into the atmosphere, refrigerants with a lower global warming potential (GWP) contribute less to global warming than those with a higher GWP. This appliance contains a refrigerant with a GWP of 675. If 1 kg of this refrigerant fluid were released into the atmosphere, therefore, the impact on global warming would be 675 times higher than 1 kg of CO₂, over a period of 100 years. Under no circumstances should the user try to intervene on the refrigerant circuit or disassemble the product. Always contact qualified personnel if necessary.

RESIDENTIAL MULTISPLIT R32

		kW	3.00	4.00	4.50	4.00	5.00	6.00	7.10	8.00	10.00
Nb. of connectable indoor units			2-2	2-2	2-2	2-3	2-3	2-3	2-4	2-4	2-5
											
			SCM 30 ZS-W	SCM 40 ZS-W	SCM 45 ZS-W	SCM 41 ZS-W	SCM 50 ZS-W	SCM 60 ZS-W	SCM 71 ZS-W	SCM 80 ZS-W	SCM 100 ZS-W
	SRK 20 ZSX-WF(T)			✓	✓		✓	✓	✓	✓	✓
	SRK 25 ZSX-WF(T)			✓	✓		✓	✓	✓	✓	✓
	SRK 35 ZSX-WF(T)			✓	✓		✓	✓	✓	✓	✓
	SRK 50 ZSX-WF(T)						✓	✓	✓	✓	✓
	SRK 60 ZSX-WF(T)							✓	✓	✓	✓
	SRK 15 ZS-WF(T)	✓				✓					
	SRK 20 ZS-WF(T)	✓	✓	✓	✓	✓	✓	✓	✓	✓	✓
	SRK 25 ZS-WF(T)	✓	✓	✓	✓	✓	✓	✓	✓	✓	✓
	SRK 35 ZS-WF(T)	✓	✓	✓	✓	✓	✓	✓	✓	✓	✓
	SRK 50 ZS-WF(T)	✓					✓	✓	✓	✓	✓
	SRK 71 ZR-WF								✓	✓	✓
	SRK 80 ZR-WF									✓	✓
	SKM 15 ZSP-W	✓				✓					
	SKM 20 ZSP-W	✓	✓	✓	✓	✓	✓	✓	✓	✓	✓
	SKM 25 ZSP-W	✓	✓	✓	✓	✓	✓	✓	✓	✓	✓
	SKM 35 ZSP-W	✓	✓	✓	✓	✓	✓	✓	✓	✓	✓
	SRF 25 ZS-W		✓	✓	✓	✓	✓	✓	✓	✓	✓
	SRF 35 ZS-W		✓	✓	✓	✓	✓	✓	✓	✓	✓
	SRK 50 ZSX-W						✓	✓	✓	✓	✓
	SRR 25 ZS-W		✓	✓	✓	✓	✓	✓	✓	✓	✓
	SRR 35 ZS-W		✓	✓	✓	✓	✓	✓	✓	✓	✓
	SRR 50 ZS-W						✓	✓	✓	✓	✓
	SRR 60 ZS-W							✓	✓	✓	✓
	FDUM 50 VH						✓	✓	✓	✓	✓
	FDE 50 VH						✓	✓	✓	✓	✓
	FDTC 25 VH1		✓	✓	✓	✓	✓	✓	✓	✓	✓
	FDTC 35 VH1		✓	✓	✓	✓	✓	✓	✓	✓	✓
	FDTC 50 VH						✓	✓	✓	✓	✓
	FDTC 60 VH							✓	✓	✓	✓

OUTDOOR UNITS

HIGH PERFORMANCE

Outdoor unit	EER*	COP*	SEER*	SCOP*
SCM 30 ZS-W	5.77	5.41	8.60 / A+++	4.80 / A++
SCM 40 ZS-W	5.00	5.42	9.10 / A+++	4.70 / A++
SCM 45 ZS-W	4.69	5.00	9.10 / A+++	4.70 / A++
SCM 41 ZS-W	5.56	5.56	9.20 / A+++	4.60 / A++
SCM 50 ZS-W	4.90	5.17	8.80 / A+++	4.60 / A++
SCM 60 ZS-W	4.55	4.86	8.80 / A+++	4.60 / A++
SCM 71 ZS-W	5.00	4.91	8.30 / A++	4.60 / A++
SCM 80 ZS-W	4.71	4.77	8.20 / A++	4.60 / A++
SCM 100 ZS-W	3.70	4.41	8.60 / A+++	4.50 / A+

* The values shown may vary depending on the combinations chosen. For further information, refer to the technical manual.

OPERATING RANGE

-15°C / +46°C

Cooling operation

OPERATING RANGE

-15°C / +24°C

Heating operation

HIGHLY COMPACT

High compactness for models 3.00 to 6.00 kW. Easy installation.

SCM 30-40-45 ZS-W



SCM 41-50-60 ZS-W



SCM 71-80 ZS-W



SCM 100 ZS-W



INSTALLATION FLEXIBILITY

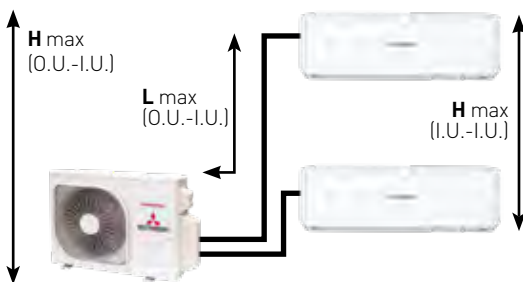

SCM 30-40-45 ZS-W

L	TOT PIPING	= 30 m
L	MAX O.U.-I.U.	= 25 m
H	MAX O.U.-I.U.	= 15 m
H	MAX I.U.-I.U.	= 25 m

SCM 41-50-60 ZS-W

L	TOT PIPING	= 40 m
L	MAX O.U.-I.U.	= 25 m
H	MAX O.U.-I.U.	= 15 m
H	MAX I.U.-I.U.	= 25 m

SCM 71-80 ZS-W

L	TOT PIPING	= 70 m
L	MAX O.U.-I.U.	= 25 m
H	MAX O.U.-I.U.	= 20 m
H	MAX I.U.-I.U.	= 25 m

SCM 100 ZS-W

L	TOT PIPING	= 75 m
L	MAX O.U.-I.U.	= 25 m
H	MAX O.U.-I.U.	= 20 m
H	MAX I.U.-I.U.	= 25 m

OUTDOOR UNITS

R32



SCM 30-40-45 ZS-W



SCM 41-50-60 ZS-W

Model	SCM 30 ZS-W		SCM 40 ZS-W		SCM 45 ZS-W		SCM 41 ZS-W		SCM 50 ZS-W		SCM 60 ZS-W			
Type	DC-Inverter Heat pump outdoor unit													
Connectable indoor units (min - max)	nb.	2 - 2		2 - 2		2 - 2		2 - 3		2 - 3		2 - 3		
Rated connectable capacity I.U. (min - max)	kW	3.00 - 5.00		4.00 - 6.00		4.50 - 7.00		4.00 - 7.00		5.00 - 8.50		6.00 - 11.00		
Nominal data														
Rated capacity (T=+35°C)	Cooling	kW	3.00 (1.40~5.00)		4.00 (1.50~5.90)		4.50 (1.50~6.40)		4.00 (1.40~6.30)		5.00 (1.70~7.10)		6.00 (1.70~7.50)	
Rated power input (T=+35°C)		kW	0.52 (0.32~1.60)		0.80 (0.34~2.10)		0.96 (0.34~2.30)		0.72 (0.32~1.65)		1.02 (0.43~2.15)		1.32 (0.43~2.28)	
Rated energy efficiency coefficient		EER ¹	5.77		5.00		4.69		5.56		4.90		4.55	
Rated capacity (T=+7°C)	Heating	kW	4.00 (1.00~5.70)		4.50 (1.00~6.30)		5.30 (1.00~6.50)		4.50 (1.00~6.90)		6.00 (1.00~7.50)		6.80 (1.00~7.80)	
Rated power input (T=+7°C)		kW	0.74 (0.25~1.49)		0.83 (0.25~1.48)		1.06 (0.25~1.48)		0.81 (0.25~1.58)		1.16 (0.32~2.50)		1.40 (0.32~2.80)	
Rated energy performance coefficient		COP ¹	5.41		5.42		5.00		5.56		5.17		4.86	
Seasonal data														
Design load (Pdesignc)	Cooling	kW	3.00		4.00		4.50		4.00		5.00		6.00	
Seasonal energy efficiency index		SEER ²	8.60		9.10		9.10		9.20		8.80		8.80	
Seasonal energy efficiency class		626/2011 ³	A+++		A+++		A+++		A+++		A+++		A+++	
Annual energy consumption		kWh/y	123		154		174		153		199		239	
Design load (Pdesignh) @ -10°C	Heating (average climate conditions)	kW	3.30		4.10		4.10		3.40		4.70		4.70	
Seasonal energy efficiency index		SCOP ²	4.80		4.70		4.70		4.60		4.60		4.60	
Seasonal energy efficiency class		626/2011 ³	A++		A++		A++		A++		A++		A++	
Annual energy consumption		kWh/y	962		1222		1222		1034		1430		1430	
Electrical data														
Power supply	Ph-V-Hz	1-220~240V-50Hz												
Power cable	Type	3 x 4 mm ²		3 x 4 mm ²		3 x 4 mm ²		3 x 4 mm ²		3 x 4 mm ²		3 x 4 mm ²		
Connection wires between each I.U. and O.U.	nb.	4		4		4		4		4		4		
Nominal absorbed current	Cooling	A	2.50		3.50		4.30		3.30		4.50		5.80	
	Heating	A	3.40		3.70		4.70		3.70		5.10		6.10	
Max current	A	14.00		14.00		14.00		15.00		15.00		15.00		
Refrigerant circuit data														
Refrigerant ⁴	Type (GWP)	R32 (675)												
Refrigerant precharge	Kg	1.25		1.40		1.40		1.60		1.80		1.80		
Tons of CO ₂ equivalent	t	0.844		0.945		0.945		1.080		1.215		1.215		
Refrigerant pipings' diameter	Liquid	6.35 (1/4") x 2		6.35 (1/4") x 2		6.35 (1/4") x 2		6.35 (1/4") x 3		6.35 (1/4") x 3		6.35 (1/4") x 3		
	Gas	9.52 (3/8") x 2		9.52 (3/8") x 2		9.52 (3/8") x 2		9.52 (3/8") x 3		9.52 (3/8") x 3		9.52 (3/8") x 3		
Total splitting distance	m	30		30		30		40		40		40		
Max length of a single refrigeration line	m	25		25		25		25		25		25		
Max splitting level difference I.U./O.U.	m	15		15		15		15		15		15		
Max splitting level difference between I.U.	m	25		25		25		25		25		25		
Max. splitting without additional charge	m	30		20		20		40		40		40		
Additional charge	g/m	20		20		20		20		20		20		
Product specifications														
Dimensions	LxDxH	mm	780(+90)x290x595		780(+90)x290x595		780(+90)x290x595		850(+65)x290x640		850(+65)x290x640		850(+65)x290x640	
Net weight	Kg	35.5		40		40		42.5		48.5		48.5		
Sound power level	Max	64		64		65		64		64		64		
	Max	51		51		52		52		52		52		
Sound pressure level	Silent mode	45		46		46		44		44		44		
	Max	1950		1950		1950		2460		2460		2460		
Air flow volume	m ³ /h	1950		1950		1950		2460		2460		2460		
Operating range (outdoor temperature)	Cooling	°C												
	Heating	°C												

1. Value measured according to the harmonised standard EN 14511. 2. EU Regulation No. 206/2012 - Value measured according to the harmonised standard EN 14825.

The values refer to the following combinations: **SCM 30 ZS-W** + 2 x SRK 15 ZS-WF / **SCM 40 ZS-W** + 2 x SRK 20 ZSX-W / **SCM 45 ZS-W** + SRK 20 ZSX-W + SRK 25 ZSX-W / **SCM 41 ZS-W** + 3 x SRK 15 ZS-WF / **SCM 50 ZS-W** + 3 x SRK 20 ZSX-W / **SCM 60 ZS-W** + 3 x SRK 20 ZSX-W.

3. Delegated Regulation (EU) No 626/2011 regarding the new energy labelling of air conditioners. 4. Refrigerant leakage contributes to climate change. When released into the atmosphere, refrigerants with a lower global warming potential (GWP) contribute less to global warming than those with a higher GWP. This appliance contains a refrigerant with a GWP of 675. If 1 kg of this refrigerant fluid were released into the atmosphere, therefore, the impact on global warming would be 675 times higher than 1 kg of CO₂, over a period of 100 years. Under no circumstances should the user try to intervene on the refrigerant circuit or disassemble the product. Always contact qualified personnel if necessary.

OUTDOOR UNITS

R32



SCM 71-80 ZS-W



SCM 100 ZS-W

Model			SCM 71 ZS-W	SCM 80 ZS-W	SCM 100 ZS-W
Type			DC-Inverter Heat pump outdoor unit		
Connectable indoor units (min - max)		nb.	2 - 4	2 - 4	*2 - 5
Rated connectable capacity I.U. (min - max)		kW	7.00 - 12.50	8.00 - 13.50	9.00 - 16.00
Nominal data					
Rated capacity (T=+35°C)	Cooling	kW	7.10 (1.80~8.80)	8.00 (1.80~9.20)	10.00 (1.70~11.50)
Rated power input (T=+35°C)		kW	1.42 (0.48~2.75)	1.70 (0.48~2.83)	2.70 (0.48~3.65)
Rated energy efficiency coefficient		EER ₁	5.00	4.71	3.70
Rated capacity (T=+7°C)	Heating	kW	8.60 (1.10~9.40)	9.30 (1.10~9.80)	10.50 (0.90~11.50)
Rated power input (T=+7°C)		kW	1.75 (0.35~3.00)	1.95 (0.35~3.12)	2.38 (0.37~2.90)
Rated energy performance coefficient		COP ₁	4.91	4.77	4.41
Seasonal data					
Design load (P _{designc})	Cooling	kW	7.10	8.00	10.00
Seasonal energy efficiency index		SEER ₂	8.30	8.20	8.60
Seasonal energy efficiency class		626/2011 ³	A++	A++	A+++
Annual energy consumption		kWh/y	300	342	407
Design load (P _{designh}) @ -10°C	Heating (average climate conditions)	kW	6.70	6.70	6.80
Seasonal energy efficiency index		SCOP ₂	4.60	4.60	4.50
Seasonal energy efficiency class		626/2011 ³	A++	A++	A+
Annual energy consumption		kWh/y	2038	2038	2116
Electrical data					
Power supply	Ph-V-Hz	1-220~240V-50Hz			
Power cable	Type	3 x 4 mm ²	3 x 4 mm ²	3 x 4 mm ²	3 x 4 mm ²
Connection wires between each I.U. and O.U.	nb.	4	4	4	4
Nominal absorbed current	Cooling	A	6.20	7.50	11.90
	Heating	A	7.80	8.60	10.50
Max current	A	20.00	20.00	21.00	21.00
Refrigerant circuit data					
Refrigerant ⁴	Type (GWP)	R32 (675)			
Refrigerant precharge	Kg	2.55	2.55	2.98	2.98
Tons of CO ₂ equivalent	t	1.721	1.721	2.012	2.012
Refrigerant pipings' diameter	Liquid	mm (inch.)	6.35 (1/4") x 4	6.35 (1/4") x 4	6.35 (1/4") x 5
	Gas		9.52 (3/8") x 4	9.52 (3/8") x 4	9.52 (3/8") x 5
Total splitting distance	m	70	70	75	
Max length of a single refrigeration line	m	25	25	25	
Max splitting level difference I.U./O.U.	m	20	20	20	
Max splitting level difference between I.U.	m	25	25	25	
Max. splitting without additional charge	m	30	30	40	
Additional charge	g/m	20	20	20	
Product specifications					
Dimensions	LxDxH	mm	880(+73)x340x750	880(+73)x340x750	970(+73)x370x945
Net weight	Kg	61	61	73	
Sound power level	Max	dB(A)	67	67	72
	Max	dB(A)	54	54	59
Sound pressure level	Silent mode	dB(A)	50	50	50
	Max	m ³ /h	3360	3360	4500
Air flow volume	Max	m ³ /h	3360	3360	4500
	Max	°C	-15~46	-15~46	-15~24
Operating range (outdoor temperature)	Cooling	°C	-15~46	-15~46	-15~24
	Heating	°C	-15~24	-15~24	-15~24

* Combinations with 2 indoor units have many limitations. Always check the proposed configuration with our Technical Office.

1. Value measured according to the harmonised standard EN 14511. 2. EU Regulation No. 206/2012 - Value measured according to the harmonised standard EN 14825.

The values refer to the following combinations: **SCM 71 ZS-W** + 4 x SRK 20 ZSX-W / **SCM 80 ZS-W** + 4 x SRK 20 ZSX-W / **SCM 100 ZS-W** + 5 x SRK 20 ZSX-W.

3. Delegated Regulation (EU) No 626/2011 regarding the new energy labelling of air conditioners. 4. Refrigerant leakage contributes to climate change. When released into the atmosphere, refrigerants with a lower global warming potential (GWP) contribute less to global warming than those with a higher GWP. This appliance contains a refrigerant with a GWP of 675. If 1 kg of this refrigerant fluid were released into the atmosphere, therefore, the impact on global warming would be 675 times higher than 1 kg of CO₂, over a period of 100 years. Under no circumstances should the user try to intervene on the refrigerant circuit or disassemble the product. Always contact qualified personnel if necessary.

INDOOR UNITS

KIREIA Plus WALL



<INCLUDED>



<REMOTE CONTROL INCLUDED>

SRK 20-25-35-50-60 ZSX-WF(T)

Model			SRK 20 ZSX-WF(T)	SRK 25 ZSX-WF(T)	SRK 35 ZSX-WF(T)	SRK 50 ZSX-WF(T)	SRK 60 ZSX-WF(T)
Type	Wall type indoor unit						
Control	Remote control						
Rated capacity	Cooling	kW	2.00	2.50	3.50	5.00	6.00
	Heating	kW	3.00	3.40	4.50	5.80	6.80
Electrical data							
Power supply	Outdoor unit	Ph-V-Hz	1-220~240V-50Hz				
Wiring cables I.U./O.U.		nb.	4	4	4	4	4
Refrigerant circuit data							
Diameter of refrigerant pipings liquid/gas		mm (inch.)	6.35(1/4") - 9.52(3/8")	6.35(1/4") - 9.52(3/8")	6.35(1/4") - 9.52(3/8")	6.35(1/4") - 12.74(1/2")	6.35(1/4") - 12.74(1/2")
Product specifications							
Dimensions	LxDxH	mm	920x220x305	920x220x305	920x220x305	920x220x305	920x220x305
Net weight		Kg	13	13	13	13	13
Sound power level (Hi)	Cooling	dB(A)	53	55	58	59	62
	Heating		55	56	58	62	63
Sound pressure level (Hi/Me/Lo/Ulo)	Cooling	dB(A)	38/31/24/19	39/33/25/19	43/35/26/19	44/39/31/22	48/41/33/22
	Heating		38/33/25/19	40/34/27/19	42/35/28/19	47/41/33/23	47/42/34/23
Air flow volume (Hi/Me/Lo/Ulo)	Cooling	m³/h	678/546/360/300	732/600/402/300	786/648/438/300	858/744/468/324	978/804/534/324
	Heating		732/618/432/324	768/660/468/324	834/708/516/324	1038/858/588/372	1068/822/654/372
Optional parts							
Wi-Fi module			Included				
Interface for home automation connection and wired control¹			SC-BIKN2-E				

1. Available home automation protocols: KNX, Modbus, BACnet. The use of the interface card SC-BIKN2-E forbids some indoor unit functions. Keep in touch with your contact person for further information.

KIREIA WALL



<INCLUDED>



<REMOTE CONTROL INCLUDED>

SRK 15-20-25-35-50 ZS-WF(T)

Model			SRK 15 ZS-WF(T)	SRK 20 ZS-WF(T)	SRK 25 ZS-WF(T)	SRK 35 ZS-WF(T)	SRK 50 ZS-WF(T)
Type	Wall type indoor unit						
Control	Remote control						
Rated capacity	Cooling	kW	1.50	2.00	2.50	3.50	5.00
	Heating	kW	2.00	3.00	3.40	4.50	5.80
Electrical data							
Power supply	Outdoor unit	Ph-V-Hz	1-220~240V-50Hz				
Wiring cables I.U./O.U.		nb.	4	4	4	4	4
Refrigerant circuit data							
Diameter of refrigerant pipings liquid/gas		mm (inch.)	6.35(1/4") - 9.52(3/8")	6.35(1/4") - 9.52(3/8")	6.35(1/4") - 9.52(3/8")	6.35(1/4") - 9.52(3/8")	6.35(1/4") - 12.74(1/2")
Product specifications							
Dimensions	LxDxH	mm	870x230x290	870x230x290	870x230x290	870x230x290	870x230x290
Net weight		Kg	9.5	9.5	9.5	9.5	10
Sound power level (Hi)	Cooling	dB(A)	48	48	50	54	59
	Heating		50	50	53	56	60
Sound pressure level (Hi/Me/Lo/Ulo)	Cooling	dB(A)	34/25/22/19	34/25/22/19	36/28/23/19	40/30/26/19	46/36/29/22
	Heating		36/29/23/19	36/29/23/19	39/30/24/19	41/36/25/19	46/37/31/24
Air flow volume (Hi/Me/Lo/Ulo)	Cooling	m³/h	558/420/354/300	558/420/354/300	594/480/354/300	678/522/420/300	726/594/444/354
	Heating		600/510/390/354	600/510/390/354	678/522/402/354	738/660/420/336	834/672/546/444
Optional parts							
Wi-Fi module			Included				
Interface for home automation connection and wired control¹			SC-BIKN2-E				

1. Available home automation protocols: KNX, Modbus, BACnet. The use of the interface card SC-BIKN2-E forbids some indoor unit functions. Keep in touch with your contact person for further information.

INDOOR UNITS

WALL



SRK 71-80 ZR-WF



<REMOTE CONTROL>
INCLUDED

Model			SRK 71 ZR-WF		SRK 80 ZR-WF	
Type			Wall type indoor unit			
Control			Remote control			
Rated capacity	Cooling	kW	7.10		8.00	
	Heating	kW	8.00		9.00	
Electrical data						
Power supply	Outdoor unit	Ph-V-Hz	1-220~240V-50Hz			
Wiring cables I.U./O.U.		nb.	4		4	
Refrigerant circuit data						
Diameter of refrigerant pipings liquid/gas		mm (inch.)	6.35(1/4") - 15.88(5/8")		6.35(1/4") - 15.88(5/8")	
Product specifications						
Dimensions	LxDxH	mm	1197x262x339		1197x262x339	
Net weight		Kg	15.5		16.5	
Sound power level (Hi)	Cooling	dB(A)	57		60	
	Heating		60		62	
Sound pressure level (Hi/Me/Lo/ULo)	Cooling	dB(A)	44/41/37/25		47/44/39/26	
	Heating		46/39/35/28		47/41/36/29	
Air flow volume (Hi/Me/Lo/ULo)	Cooling	m³/h	1230/1116/972/624		1410/1212/1050/624	
	Heating		1500/1188/1038/798		1590/1278/1104/810	
Optional parts						
Wi-Fi module			Included			
Interface for home automation connection and wired control¹			SC-BIKN2-E			

1. Available home automation protocols: KNX, Modbus, BACnet. The use of the interface card SC-BIKN2-E forbids some indoor unit functions. Keep in touch with your contact person for further information.

WALL



SKM 15-20-25-35 ZSP-W



<REMOTE CONTROL>
INCLUDED

Model			SKM 15 ZSP-W	SKM 20 ZSP-W	SKM 25 ZSP-W	SKM 35 ZSP-W
Type			Wall type indoor unit			
Control			Remote control			
Rated capacity	Cooling	kW	1.50	2.00	2.50	3.50
	Heating	kW	2.00	3.00	3.40	4.50
Electrical data						
Power supply	Outdoor unit	Ph-V-Hz	1-220~240V-50Hz			
Wiring cables I.U./O.U.		nb.	4	4	4	4
Refrigerant circuit data						
Diameter of refrigerant pipings liquid/gas		mm (inch.)	6.35(1/4") - 9.52(3/8")	6.35(1/4") - 9.52(3/8")	6.35(1/4") - 9.52(3/8")	6.35(1/4") - 9.52(3/8")
Product specifications						
Dimensions	LxDxH	mm	783x210x267	783x210x267	783x210x267	783x210x267
Net weight		Kg	7.5	7.5	7.5	7.5
Sound power level (Hi)	Cooling	dB(A)	57	57	57	58
	Heating		56	56	56	58
Sound pressure level (Hi/Me/Lo)	Cooling	dB(A)	42/35/22	42/35/22	43/36/23	44/37/25
	Heating		41/36/26	41/36/26	41/36/27	42/37/30
Air flow volume (Hi/Me/Lo)	Cooling	m³/h	510/420/300	510/420/300	510/420/300	540/450/300
	Heating		480/420/330	480/420/330	480/420/330	510/420/360
Optional parts						
Wi-Fi module			INWFIUNIO011000			
Interface for home automation connection and wired control			Not available for this product			

INDOOR UNITS

DUCTED LOW STATIC PRESSURE



SRR 25-35-50-60 ZS-W



< REMOTE CONTROL >
INCLUDED

Model			SRR 25 ZS-W	SRR 35 ZS-W	SRR 50 ZS-W	SRR 60 ZS-W
Type			Ducted type indoor unit			
Control			Remote control			
Rated capacity	Cooling	kW	2.50	3.50	5.00	6.00
	Heating	kW	3.40	4.50	5.80	6.80
Electrical data						
Power supply	Outdoor unit	Ph-V-Hz	1-220~240V-50Hz			
Wiring cables I.U./O.U.		nb.	4	4	4	4
Refrigerant circuit data						
Diameter of refrigerant pipings liquid/gas		mm (inch.)	6.35(1/4") - 9.52(3/8")	6.35(1/4") - 9.52(3/8")	6.35(1/4") - 12.74(1/2")	6.35(1/4") - 12.74(1/2")
Product specifications						
Dimensions	LxDxH	mm	750x500x200	750x500x200	950x500x200	950x500x200
Net weight		Kg	20.5	20.5	24	24
Sound power level (Hi)	Cooling	dB(A)	56	57	59	60
	Heating		59	60	61	63
Sound pressure level (Hi/Me/Lo/ULo)	Cooling	dB(A)	37/33/30/24	38/34/31/25	41/37/34/29	44/38/35/30
	Heating		40/37/34/28	42/38/35/29	43/39/37/32	45/41/38/33
Air flow volume (Hi/Me/Lo/ULo)	Cooling	m³/h	570/480/390/270	600/510/420/300	810/660/600/450	870/690/630/480
	Heating		600/540/480/360	630/570/510/390	840/750/660/510	900/780/690/540
Fan static pressure	Std/Max	Pa	5/35	5/35	5/50	5/50
Optional parts						
Wi-Fi module ¹			WF-RAC			
Interface for home automation connection and wired control ²			SC-BIKN2-E			
Kit for recovery from bottom			UT-BAT1EF		UT-BAT2EF	

- Using the Wi-Fi module excludes the possibility of connecting any other optional accessory.
- Home automation protocols available: KNX, Modbus, BACnet.

CONSOLE



SRF 25-35 ZS-W
SRF 50 ZSX-W



< REMOTE CONTROL >
INCLUDED

Model			SRF 25 ZS-W	SRF 35 ZS-W	SRF 50 ZSX-W
Type			Floor type indoor unit		
Control			Remote control		
Rated capacity	Cooling	kW	2.50	3.50	5.00
	Heating	kW	3.40	4.50	5.80
Electrical data					
Power supply	Outdoor unit	Ph-V-Hz	1-220~240V-50Hz		
Wiring cables I.U./O.U.		nb.	4	4	4
Refrigerant circuit data					
Diameter of refrigerant pipings liquid/gas		mm (inch.)	6.35(1/4") - 9.52(3/8")	6.35(1/4") - 9.52(3/8")	6.35(1/4") - 12.74(1/2")
Product specifications					
Dimensions	LxDxH	mm	860x238x600	860x238x600	860x238x600
Net weight		Kg	18	19	19
Sound power level (Hi)	Cooling	dB(A)	50	51	58
	Heating		51	52	58
Sound pressure level (Hi/Me/Lo/ULo)	Cooling	dB(A)	38/32/29/25	40/35/33/29	46/38/33/28
	Heating		39/35/33/39	41/36/35/33	46/41/38/32
Air flow volume (Hi/Me/Lo/ULo)	Cooling	m³/h	540/456/402/348	552/468/438/384	690/576/444/396
	Heating		630/492/462/396	642/498/486/444	720/600/564/456
Optional parts					
Wi-Fi module ¹			WF-RAC		
Interface for home automation connection and wired control ²			SC-BIKN2-E		

- Using the Wi-Fi module excludes the possibility of connecting any other optional accessory.
- Home automation protocols available: KNX, Modbus, BACnet.

INDOOR UNITS

DUCTED MEDIUM STATIC PRESSURE



FDUM 50 VH



OPTIONAL

Compatible with  AIRZONE systems

Model			FDUM 50 VH
Type			Ducted type indoor unit
Rated capacity	Cooling	kW	5.00
	Heating	kW	5.80
Electrical data			
Power supply	Outdoor unit	Ph-V-Hz	1-220~240V-50Hz
Wiring cables I.U./O.U.		nb.	4
Refrigerant circuit data			
Diameter of refrigerant pipings liquid/gas		mm (inch.)	6.35(1/4") - 12.74(1/2")
Product specifications			
Dimensions	LxDxH	mm	750x635x280
Net weight		Kg	29
Sound power level	Max	dB(A)	60
Sound pressure level	P-Hi/Hi/Me/Lo	dB(A)	37/32/29/26
Air flow volume	P-Hi/Hi/Me/Lo	m ³ /h	780/600/540/480
Fan static pressure	Std/Max	Pa	35/100
Accessories			
Wired control			RC-E5 / RC-EX3A / RC-EXZ3A / RCH-E3
IR remote control (KIT)			RCN-KIT4-E2
Optional parts			
Wi-Fi module			INWFIMHI001R100
Human sensor (KIT)			LB-KIT2
SUPERLINK interface II			SC-ADNA-E
Recovery filter (KIT)			UM-FL1EF

CEILING



FDE 50 VH



OPTIONAL

Model			FDE 50 VH
Type			Ceiling type indoor unit
Rated capacity	Cooling	kW	5.00
	Heating	kW	5.80
Electrical data			
Power supply	Outdoor unit	Ph-V-Hz	1-220~240V-50Hz
Wiring cables I.U./O.U.		nb.	4
Refrigerant circuit data			
Diameter of refrigerant pipings liquid/gas		mm (inch.)	6,35(1/4") - 12,74(1/2")
Product specifications			
Dimensions	LxDxH	mm	1070x690x210
Net weight		Kg	28
Sound power level	Max	dB(A)	60
Sound pressure level	P-Hi/Hi/Me/Lo	dB(A)	46/38/36/31
Air flow volume	P-Hi/Hi/Me/Lo	m ³ /h	780/600/540/420
Accessories			
Wired control			RC-E5 / RC-EX3A / RCH-E3
IR remote control (KIT)			RCN-E-E3
Optional parts			
Wi-Fi module			INWFIMHI001R100
Human sensor (KIT)			LB-E
SUPERLINK interface II			SC-ADNA-E

INDOOR UNITS

ULTRACOMPACT CASSETTE 60X60



FDTC 25-35 VH1/FDTC 50-60 VH
Standard honeycomb panel
TC-PSA-5AW-E

FDTC 25-35 VH1/FDTC 50-60 VH
Anti-draft honeycomb panel
TC-PSAE-5AW-E

FDTC 25-35 VH1/FDTC 50-60 VH
Standard linear panel
TC-PSAG-5AW-E

FDTC 25-35 VH1/FDTC 50-60 VH
Anti-draft linear panel
TC-PSAGE-5AW-E

Model			FDTC 25 VH1	FDTC 35 VH1	FDTC 50 VH	FDTC 60 VH
Type			Cassette type indoor unit			
Rated capacity	Cooling	kW	2.50	3.50	5.00	6.00
	Heating	kW	3.40	4.50	5.80	6.80
Electrical data						
Power supply	Outdoor unit	Ph-V-Hz	1-220~240V-50Hz			
Wiring cables I.U./O.U.		nb.	4	4	4	4
Refrigerant circuit data						
Diameter of refrigerant pipings liquid/gas		mm (inch.)	6.35(1/4") - 9.52(3/8")	6.35(1/4") - 9.52(3/8")	6.35(1/4") - 12.74(1/2")	6.35(1/4") - 12.74(1/2")
Product specifications						
Dimensions	LxDxH	mm	570x570x248	570x570x248	570x570x248	570x570x248
Net weight		Kg	13.5	13.5	14	14
Sound power level (Hi)	Cooling	dB(A)	51	52	59	60
	Heating		52	53	59	60
Sound pressure level (P-Hi/Hi/Me/Lo)	Cooling	dB(A)	38/34/30/27	39/36/32/29	44/40/35/27	46/42/38/31
	Heating		39/36/32/28	41/38/34/30	44/40/35/27	46/42/38/31
Air flow volume (P-Hi/Hi/Me/Lo)	Cooling	m³/h	510/450/420/360	540/480/450/390	780/660/540/420	840/720/600/480
	Heating		570/510/450/390	600/540/480/420		
Accessories						
Decorative panel			TC-PSA-5AW-E (honeycomb) / TC-PSAG-5AW-E (linear)			
Panel size	LxDxH	mm	620x620x10	620x620x10	620x620x10	620x620x10
Net weight		Kg	2.5	2.5	2.5	2.5
Wired control			RC-E5 (LCD) / RC-EX3A (touch) / RCH-E3 (simplified)			
IR remote control (corner KIT)			RCN-TC-5AW-E3			
Optional parts						
Wi-Fi module			INWFIMH1001R100			
Human sensor (corner KIT)			LB-TC-5W-E			
SUPERLINK interface II			SC-ADNA-E			
Anti-draft panel			TC-PSAE-5AW-E (honeycomb) / TC-PSAGE-5AW-E (linear)			





COMMERCIAL
MONO & MULTI
R32



COMMERCIAL MONO & MULTI



52 R32 COMMERCIAL CHARACTERISTICS

56 LINE-UP R32

COMMERCIAL MONOSPLIT

58 HYPER R32 series

66 SUPER R32 series

74 SMART R32 series

COMMERCIAL MULTISPLIT

82 HYPER series R32 combinations

84 SUPER series R32 combinations

86 ENTHALPY HEAT RECOVERY UNIT

88 AIR HANDLING UNIT INTERFACE

MHI commercial range air conditioners have been designed for ample spaces like offices and companies and for small and medium applications.

MHI offers all possible useful solutions to combine operating costs, flexibility and maintenance, depending on the area and characteristics of the work environment.

HIGH PERFORMANCE WITH R32

MHI introduces R32 refrigerant gas on its entire commercial line. The new, more ecological technology guarantees energy savings for all capacities.

Reliable, innovative, environmentally friendly: commercial line air conditioners have all the characteristics to meet the most varied installation requirements.



FDC100 VSX-W (4HP) - 3-PHASE

Rated heating capacity kept constant down to -15° C.

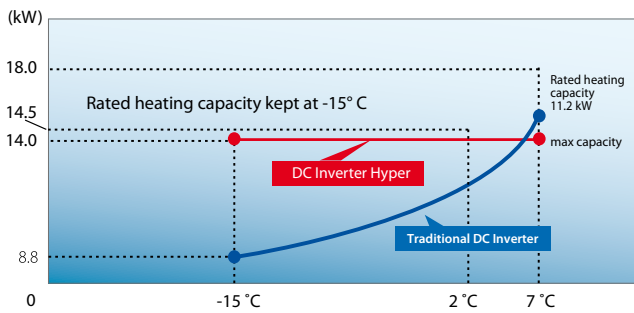

SUPER HEAT: START-UP AT HIGH TEMP.

At start-up, the unit reaches the temperature of 40° C in only 4 minutes - in an operating condition with indoor and outdoor temperature of 2° C - and can reach 50° C in the following 8 minutes.

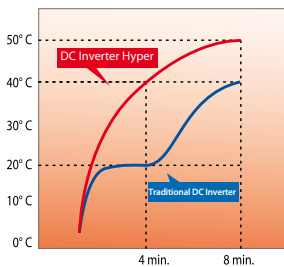

Refer to technical specifications concerning the following: application conditions, operating range and heating/cooling capacity.

OPERATING RANGE

HYPER VSX-W

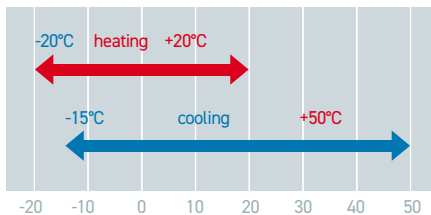

The new advanced technology, installed on R32 units, has extended the range of cooling operation compared to R410A units, making it possible for the systems to be installed in locations with more extreme climatic conditions.

LESS CORROSION THANKS TO BLUE FIN

The particular coating of the heat exchanger louvers guarantees perfect resistance to corrosion and deterioration caused by atmospheric agents.

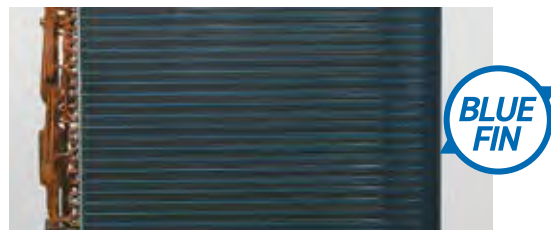



SPLITTING DISTANCE OF 100 M, HIGH INSTALLATION FLEXIBILITY

The maximum length of the refrigerant pipes can be up to 100 m. The maximum height difference between indoor units is 15 m. Each unit is also equipped with a refrigerant pre-load sufficient for 30 m splitting distance.

The versatility offered by the numerous installation solutions also makes it possible to centralise the systems via the Superlink network, applying the SC-ADNA-E adapter to each indoor unit to be controlled.

4-5-6HP VSX models (3-Phase)

Series	Piping length	Height difference
Hyper 4~6	100 m	50 m
Super 4~6	50 m	50 m
Smart 3~5	30 m	20 m

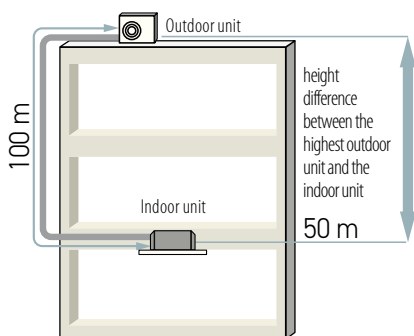

4~6HP	
Total length of piping	100 m
Height difference	50 m

DC TWIN ROTARY COMPRESSOR

Reduction in size and increase in energy performance (4~6HP models). The application of DC Twin Rotary compressor allows units to reach 120rps speed. Improved performance and vibration reduction are guaranteed by the use of the Inverter Vector control.



ADVANCED TECHNOLOGY WITH THE HUMAN SENSOR

The most advanced solution for controlling room temperature and comfort. The HUMAN SENSOR detects the presence of people in the room and the type of activity occurring; the temperature is adjusted accordingly automatically, with beneficial effects on consumption and well-being.

ENERGY SAVINGS THROUGH MOTION DETECTION IN THE ROOM

The HUMAN SENSOR detects the presence/absence and/or movement of persons in the room to improve comfort and performance, thanks to the unit's energy saving functions.

3 ENERGY SAVING CONTROL MODES

1. POWER CONTROL

The new motion sensor detects human activity in the room. Energy saving control is obtained by modifying the set temperature based on the amount and type of detected activity.

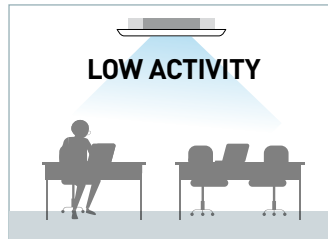

Power control increases energy saving.

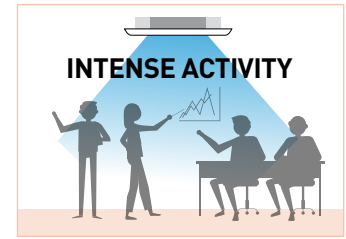

Power control increases comfort.

2. AUTO-OFF: STAND BY

The unit stops running if no activity is detected for 1 hour. It re-starts automatically when activity is detected.

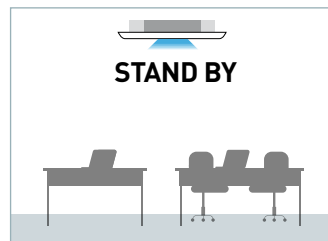

Operation shuts off temporarily.

3. AUTO-OFF TOTAL SHUT-DOWN

The unit shuts down automatically if no activity is detected for 12 hours.

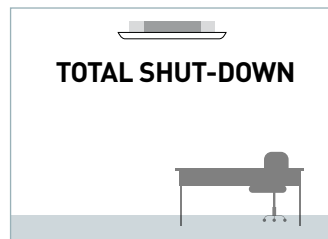

Operation shuts off completely.

AVAILABLE AS AN OPTIONAL FOR THE FOLLOWING INDOOR UNIT MODELS:

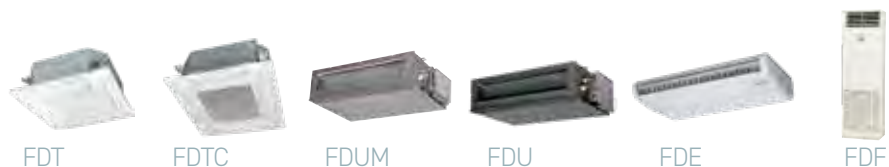

COMMERCIAL MONOSPLIT R32

Outdoor units		HYPER				SUPER						SMART			
															
		FDC VNX-W		FDC VSX-W		FDC VNA-W/VSA-W		FDC VSA-W				FDC VNP-W			
kW		7.10	10.00	12.50	14.00	10.00	12.50	14.00	20.00	25.00	28.00	7.10	9.00	10.00	12.50
INDOOR UNITS	FDT VH 	✓	✓	✓	✓	✓	✓	✓				✓	✓	✓	✓
	FDUM VH 	✓	✓	✓	✓	✓	✓	✓				✓	✓	✓	✓
	FDU VH 	✓	✓	✓	✓	✓	✓	✓	✓	✓	✓	✓	✓	✓	✓
	FDE VH 	✓	✓	✓	✓	✓	✓	✓				✓	✓	✓	✓
	SRK ZR-WF 	✓	✓				✓					✓		✓	
	FDV VH 	✓	✓	✓	✓	✓	✓	✓				✓	✓	✓	

MULTISPLIT COMBINATIONS TWIN/TRIPLE/DOUBLE TWIN R32

VALID COMBINATIONS FOR HYPER AND SUPER SERIES

HYPER

	TWIN	TRIPLE
FDC 71 VNX-W	40+40	-
FDC 100 VSX-W	50+50	-
FDC 125 VSX-W	60+60	-
FDC 140 VSX-W	71+71	50+50+50

SUPER

	TWIN	TRIPLE	DOUBLE TWIN
FDC 100 VNA-W/FDC 100 VSA-W	50+50	-	-
FDC 125 VNA-W/FDC 125 VSA-W	60+60	-	-
FDC 140 VNA-W/FDC 140 VSA-W	71+71	50+50+50	-
FDC 200 VSA-W	100+100	71+71+71	50+50+50+50
FDC 250 VSA-W	125+125	-	60+60+60+60
FDC 280 VSA-W	140+140	-	71+71+71+71



Note: Combinations other than those indicated on pages 82-85 are prohibited.

MULTISPLIT COMBINATIONS V MULTI R32

VALID COMBINATIONS FOR HYPER AND SUPER SERIES

HYPER

	TWIN	TRIPLE
FDC 71 VNX-W	40+40	-
FDC 100 VSX-W	50+50	-
FDC 125 VSX-W	60+60	-
	50+71	-
FDC 140 VSX-W	71+71	50+50+50

SUPER

	TWIN	TRIPLE	DOUBLE TWIN
FDC 100 VNA-W/FDC 100 VSA-W	50+50	-	-
FDC 125 VNA-W/FDC 125 VSA-W	60+60	-	-
	50+71	-	-
FDC 140 VNA-W/FDC 140 VSA-W	71+71	50+50+50	-
FDC 200 VSA-W	100+100	71+71+71	50+50+50+50
	71+125		
FDC 250 VSA-W	125+125	60+60+125	60+60+60+60
		71+71+100	
FDC 280 VSA-W	140+140	71+71+140	71+71+71+71



Note: Combinations other than those indicated on pages 82-85 are prohibited.

SERIE HYPER



Operation in heating mode with outside temperature limit of: -20°C

If the outdoor temperature decreases, the supplied power keeps constant

■ **4 capacities**

1-Phase 3HP= 7.10 kW
3-Phase 4~6HP=10.00~14.00 kW

- Minimum outdoor operating temperature
- Super Heat at start-up
- The supplied power is kept also as the outdoor temperature decreases
- **100 m**
Splitting distance
- Application of Twin Rotary compressors: reduction in size and increase in performance

VNX-W = 1-PHASE
VSX-W = 3-PHASE



FDC 71 VNX-W (3HP)



FDC100 VSX-W (4HP)
FDC125 VSX-W (5HP)
FDC140 VSX-W (6HP)

MONOSPLIT HYPER

CASSETTE 84X84

R32



FDT 71-100-125-140 VH
Standard white panel
T-PSA-5BW-E

FDT 71-100-125-140 VH
Anti-draft white panel
T-PSAE-5BW-E

FDT 71-100-125-140 VH
Standard black panel
T-PSA-5BB-E

FDT 71-100-125-140 VH
Black anti-draft panel
T-PSAE-5BB-E

Indoor unit model		FDT 71 VH	FDT 100 VH	FDT 125 VH	FDT 140 VH	
Outdoor unit model		FDC 71 VNX-W	FDC 100 VSX-W	FDC 125 VSX-W	FDC 140 VSX-W	
Type		DC-Inverter heat pump				
Nominal data						
Rated capacity (T=+35°C)	Cooling	kW	7.10 (3.20~8.00)	10.00 (3.50~11.20)	12.50 (3.50~14.00)	14.00 (3.50~16.00)
Rated power input (T=+35°C)		kW	1.69	2.28	3.21	3.87
Rated energy efficiency coefficient		EER ¹	4.20	4.38	3.89	3.62
Rated capacity (T=+7°C)	Heating	kW	8.00 (3.60~9.00)	11.20 (2.70~16.00)	14.00 (2.70~18.00)	16.00 (2.70~20.00)
Rated power input (T=+7°C)		kW	1.75	2.48	3.43	4.20
Rated energy performance coefficient		COP ¹	4.58	4.52	4.08	3.81
Seasonal data						
Design load (Pdesigngc)	Cooling	kW	7.10	10.00	12.50	14.00
Seasonal energy efficiency index		SEER ²	7.60	8.00	7.64	7.20
Seasonal energy efficiency class		626/2011 ³	A++	A++	-	-
Annual energy consumption		kWh/y	327	438	-	-
Design load (Pdesigngh) @ -10°C	Heating (average climate conditions)	kW	5.80	11.20	14.00	16.00
Seasonal energy efficiency index		SCOP ²	4.61	4.44	4.26	4.14
Seasonal energy efficiency class		626/2011 ³	A++	A+	-	-
Annual energy consumption		kWh/y	1762	3534	-	-
Electrical data						
Power supply	Outdoor unit	Ph-V-Hz	1-220~240V-50Hz		3-380~415V-50Hz	
Power cable		Type	3 x 4 mm ²		5 x 4 mm ²	
Connection wires between I.U. and O.U.		nb.	4		4	
Nominal absorbed current	Cooling	A	7.50		5.20	
	Heating	A	7.80		5.60	
Maximum current		A	19.10		14.00	
Max power input		kW	4.11		8.90	
Refrigerant circuit data						
Refrigerant ⁴		Type (GWP)	R32 (675)			
Quantity of refrigerant pre-charge		Kg	2.75		4	
Tons of CO ₂ equivalent		t	1.856		2.700	
Diameter of refrigerant pipings liquid/gas		mm (inches)	ø9.52 (3/8") - ø15.88(5/8")		ø9.52 (3/8") - ø15.88(5/8")	
Splitting distance	Min/Max	m	3/50		3/100	
Splitting level difference I.U./O.U.	O.U. above/O.U. below	m	30/15		50/15	
Splitting distance without additional charge		m	30		30	
Additional charge		g/m	54		54	
Indoor unit specifications						
Dimensions	LxDxH	mm	840x840x236		840x840x298	
Net weight		Kg	21		25	
Sound power level	Max	dB(A)	60		64	
Sound pressure level (P-Hi/Hi/Mi/Lo)	Cooling	dB(A)	46/34/31/26		47/39/36/30	
	Heating		47/39/36/29		48/41/39/31	
Volume of air treated	P-Hi/Hi/Me/Lo	m ³ /h	1680/1080/900/720		2220/1560/1380/1020	
			2280/1680/1500/1080		2280/1740/1560/1140	
Outdoor unit specifications						
Dimensions	LxDxH	mm	880(+88)x340x750		970x370x1300	
Net weight		Kg	60		99	
Sound power level	Max	dB(A)	66		70	
Sound pressure level	Max	dB(A)	51		54	
Volume of air treated	Max	m ³ /h	3600		6000	
Operating range (outdoor temperature)	Cooling	°C	-15~+50			
	Heating	°C	-20~+20			
Accessories						
Decorative panel			T-PSA-5BW-E (white) / T-PSA-5BB-E (black)			
Panel size	LxDxH	mm	950x950x35		950x950x35	
Net weight		Kg	5		5	
Wired control	RC-E5 (LCD) / RC-EX3A (touch) / RCH-E3 (simplified)					
IR remote control (corner KIT)	RCN-T-5BW-E2 (white) / RCN-T-5BB-E2 (black)					
Optional parts						
Wi-Fi module	INWFIMH001R100					
Human sensor (corner KIT)	LB-T-5BW-E (white) / LB-T-5BB-E (black)					
SUPERLINK II interface	SC-ADNA-E					
Anti-draft panel	T-PSAE-5BW-E (white) / T-PSAE-5BB-E (black)					

1. Value measured according to the harmonised standard EN 14511. 2. EU Regulation No. 206/2012 - - Value measured according to the harmonised standard EN 14825. 3. Delegated Regulation (EU) No 626/2011 regarding the new energy labelling of air conditioners. 4. Refrigerant leakage contributes to climate change. When released into the atmosphere, refrigerants with a lower global warming potential (GWP) contribute less to global warming than those with a higher GWP. This appliance contains a refrigerant with a GWP of 675. If 1 kg of this refrigerant fluid were released into the atmosphere, therefore, the impact on global warming would be 675 times higher than 1 kg of CO₂ over a period of 100 years. Under no circumstances should the user try to intervene on the refrigerant circuit or disassemble the product. Always contact qualified personnel if necessary.

MONOSPLIT HYPER

DUCTED MEDIUM STATIC PRESSURE ADJUSTABLE

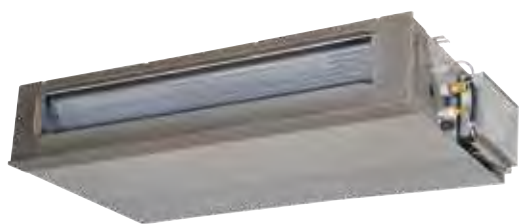

- **max 100**
Fan static pressure
- Unit with bottom or rear air intake (filter not included)
- **280 mm**
Height
- **100 m**
Splitting distance
- ESP function: automatic maintenance of the air flow as flow resistance varies
- Filter not included
- Compatible with **AIRZONE** systems

FDUM 71-100-125-140 VH

Indoor unit model			FDUM 71 VH	FDUM 100 VH	FDUM 125 VH	FDUM 140 VH
Outdoor unit model			FDC 71 VNX-W	FDC 100 VSX-W	FDC 125 VSX-W	FDC 140 VSX-W
Type			DC-Inverter heat pump			
Nominal data						
Rated capacity (T=+35°C)	Cooling	kW	7.10 (3.20~8.00)	10.00 (3.50~11.20)	12.50 (3.50~14.00)	14.00 (3.50~16.00)
Rated power input (T=+35°C)		kW	1.77	2.59	3.49	4.22
Rated energy efficiency coefficient		EER ¹	4.01	3.86	3.58	3.32
Rated capacity (T=+7°C)	Heating	kW	8.00 (3.60~9.00)	11.20 (2.70~16.00)	14.00 (2.70~18.00)	16.00 (2.70~20.00)
Rated power input (T=+7°C)		kW	1.78	2.63	3.61	4.22
Rated energy performance coefficient		COP ¹	4.49	4.26	3.88	3.79
Seasonal data						
Design load (Pdesignc)	Cooling	kW	7.10	10.00	12.50	14.00
Seasonal energy efficiency index		SEER ²	6.89	6.29	6.10	5.79
Seasonal energy efficiency class		626/2011 ³	A++	A++	-	-
Annual energy consumption		kWh/y	361	557	-	-
Design load (Pdesignh) @ -10°C	Heating (average climate conditions)	kW	6.00	11.20	14.00	16.00
Seasonal energy efficiency index		SCOP ²	4.45	4.13	3.92	3.88
Seasonal energy efficiency class		626/2011 ³	A+	A+	-	-
Annual energy consumption		kWh/y	1889	3800	-	-
Electrical data						
Power supply	Outdoor unit	Ph-V-Hz	1-220~240V-50Hz		3-380~415V-50Hz	
Power cable		Type	3 x 4 mm ²	5 x 4 mm ²	5 x 4 mm ²	5 x 4 mm ²
Connection wires between I.U. and O.U.		nb.	4	4	4	4
Nominal absorbed current	Cooling	A	7.90	4.40	5.60	6.70
	Heating	A	7.90	4.40	5.90	6.80
Maximum current		A	20.00	17.00	16.00	17.00
Max power input		kW	4.11	8.90	8.90	8.90
Refrigerant circuit data						
Refrigerant ⁴		Type (GWP)	R32 (675)			
Quantity of refrigerant pre-charge		Kg	2.75	4	4	4
Tons of CO2 equivalent		t	1.856	2.700	2.700	2.700
Diameter of refrigerant pipings liquid/gas		mm (inches)	ø9.52 (3/8") - ø15.88(5/8")	ø9.52 (3/8") - ø15.88(5/8")	ø9.52 (3/8") - ø15.88(5/8")	ø9.52 (3/8") - ø15.88(5/8")
Splitting distance	Min/Max	m	3/50	3/100	3/100	3/100
Splitting level difference I.U./O.U.	O.U. above/O.U. below	m	30/15	50/15	50/15	50/15
Splitting distance without additional charge		m	30	30	30	30
Additional charge		g/m	54	54	54	54
Indoor unit specifications						
Dimensions	LxDxH	mm	950x635x280	1370x740x280	1370x740x280	1370x740x280
Net weight		Kg	34	54	54	54
Sound power level	Max	dB(A)	65	65	67	70
Sound pressure level	P-Hi/Hi/Me/Lo	dB(A)	38/33/29/25	44/38/36/30	45/40/34/29	47/40/35/30
Volume of air treated	P-Hi/Hi/Me/Lo	m ³ /h	1440/1140/900/600	2160/1680/1500/1140	2340/1920/1560/1200	2880/2100/1680/1320
Fan static pressure	Std/Max	Pa	35/100	60/100	60/100	60/100
Outdoor unit specifications						
Dimensions	LxDxH	mm	880(+88)x340x750	970x370x1300	970x370x1300	970x370x1300
Net weight		Kg	60	99	99	99
Sound power level	Max	dB(A)	66	67	70	71
Sound pressure level	Max	dB(A)	51	53	54	54
Volume of air treated	Max	m ³ /h	3600	6000	6000	6000
Operating range (outdoor temperature)	Cooling	°C	-15~+50			
	Heating	°C	-20~+20			
Accessories						
Wired control	RC-E5 (LCD) / RC-EX3A (touch) / RC-EX23A (touch + zone control) / RCH-E3 (simplified)					
IR remote control (KIT)	RCN-KIT4-E2					
Optional parts						
Wi-Fi module	INWFIMH001R100					
Human sensor (KIT)	LB-KIT2					
SUPERLINK II interface	SC-ADNA-E					
Recovery filter (KIT)	UM-FL2EF		UM-FL3EF			

1. Value measured according to the harmonised standard EN 14511. 2. EU Regulation No. 206/2012 -- Value measured according to the harmonised standard EN 14825. 3. Delegated Regulation (EU) No 626/2011 regarding the new energy labelling of air conditioners. 4. Refrigerant leakage contributes to climate change. When released into the atmosphere, refrigerants with a lower global warming potential (GWP) contribute less to global warming than those with a higher GWP. This appliance contains a refrigerant with a GWP of 675. If 1 kg of this refrigerant fluid were released into the atmosphere, therefore, the impact on global warming would be 675 times higher than 1 kg of CO₂ over a period of 100 years. Under no circumstances should the user try to intervene on the refrigerant circuit or disassemble the product. Always contact qualified personnel if necessary.

MONOSPLIT HYPER

DUCTED HIGH STATIC PRESSURE ADJUSTABLE



FDU 71-100-125-140 VH

- **max 200**
Fan static pressure
- Unit with bottom or rear air intake (filter not included)
- **280 mm**
Height
- **100 m**
Splitting distance
- ESP function: automatic maintenance of the air flow as flow resistance varies
- Filter not included
- Compatible with  AIRZONE systems

Indoor unit model	FDU 71 VH		FDU 100 VH		FDU 125 VH		FDU 140 VH	
Outdoor unit model	FDC 71 VNX-W		FDC 100 VSX-W		FDC 125 VSX-W		FDC 140 VSX-W	
Type	DC-Inverter heat pump							
Nominal data								
Rated capacity (T=+35°C)	Cooling	kW	7.10 (3.20~8.00)	10.00 (3.50~11.20)	12.50 (3.50~14.00)	14.00 (3.50~16.00)		
Rated power input (T=+35°C)		kW	1.77	2.59	3.49	4.22		
Rated energy efficiency coefficient		EER ¹	4.01	3.86	3.58	3.32		
Rated capacity (T=+7°C)	Heating	kW	8.00 (3.60~9.00)	11.20 (2.70~16.00)	14.00 (2.70~18.00)	16.00 (2.70~20.00)		
Rated power input (T=+7°C)		kW	1.78	2.63	3.61	4.22		
Rated energy performance coefficient		COP ¹	4.49	4.26	3.88	3.79		
Seasonal data								
Design load (Pdesignc)	Cooling	kW	7.10	10.00	12.50	14.00		
Seasonal energy efficiency index		SEER ²	6.89	6.29	6.10	5.79		
Seasonal energy efficiency class		626/2011 ³	A++	A++	-	-		
Annual energy consumption		kWh/y	361	557	-	-		
Design load (Pdesignh) @ -10°C	Heating (average climate conditions)	kW	6.00	11.20	14.00	16.00		
Seasonal energy efficiency index		SCOP ²	4.47	4.13	3.92	3.88		
Seasonal energy efficiency class		626/2011 ³	A+	A+	-	-		
Annual energy consumption		kWh/y	1878	3800	-	-		
Electrical data								
Power supply	Outdoor unit	Ph-V-Hz	1-220~240V-50Hz			3-380~415V-50Hz		
Power cable		Type	3 x 4 mm ²		5 x 4 mm ²		5 x 4 mm ²	
Connection wires between I.U. and O.U.		nb.	4		4		4	
Nominal absorbed current	Cooling	A	7.90		4.40		5.60	
	Heating	A	7.90		4.40		5.90	
Maximum current		A	20.00		15.00		16.00	
Max power input		kW	4.11		8.90		8.90	
Refrigerant circuit data								
Refrigerant ⁴		Type (GWP)	R32 (675)					
Quantity of refrigerant pre-charge		Kg	2.75		4		4	
Tons of CO2 equivalent		t	1.856		2.700		2.700	
Diameter of refrigerant pipings liquid/gas		mm (inches)	9.52 (3/8") - 15.88(5/8")		9.52 (3/8") - 15.88(5/8")		9.52 (3/8") - 15.88(5/8")	
Splitting distance	Min/Max	m	3/50		3/100		3/100	
Splitting level difference I.U./O.U.	O.U. above/O.U. below	m	30/15		50/15		50/15	
Splitting distance without additional charge		m	30		30		30	
Additional charge		g/m	54		54		54	
Indoor unit specifications								
Dimensions	LxDxH	mm	950x635x280		1370x740x280		1370x740x280	
Net weight		Kg	34		54		54	
Sound power level	Max	dB(A)	65		65		70	
Sound pressure level	P-Hi/Hi/Me/Lo	dB(A)	38/33/29/25		44/38/36/30		45/40/34/29	
Volume of air treated	P-Hi/Hi/Me/Lo	m ³ /h	1440/1140/900/600		2160/1680/1500/1140		2340/1920/1560/1200	
Fan static pressure	Std/Max	Pa	35/200		60/200		60/200	
Outdoor unit specifications								
Dimensions	LxDxH	mm	880(+88)x340x750		970x370x1300		970x370x1300	
Net weight		Kg	60		99		99	
Sound power level	Max	dB(A)	66		67		70	
Sound pressure level	Max	dB(A)	51		53		54	
Volume of air treated	Max	m ³ /h	3600		6000		6000	
Operating range (outdoor temperature)	Cooling	°C	-15~+50					
	Heating	°C	-20~+20					
Accessories								
Wired control	RC-E5 (LCD) / RC-EX3A (touch) / RC-EXZ3A (touch + zone control) / RCH-E3 (simplified)							
IR remote control (KIT)	RCN-KIT4-E2							
Optional parts								
Wi-Fi module	INWFIMH001R100							
Human sensor (KIT)	LB-KIT2							
SUPERLINK II interface	SC-ADNA-E							

1. Value measured according to the harmonised standard EN 14511. 2. EU Regulation No. 206/2012 -- Value measured according to the harmonised standard EN 14825. 3. Delegated Regulation (EU) No 626/2011 regarding the new energy labelling of air conditioners. 4. Refrigerant leakage contributes to climate change. When released into the atmosphere, refrigerants with a lower global warming potential (GWP) contribute less to global warming than those with a higher GWP. This appliance contains a refrigerant with a GWP of 675. If 1 kg of this refrigerant fluid were released into the atmosphere, therefore, the impact on global warming would be 675 times higher than 1 kg of CO₂ over a period of 100 years. Under no circumstances should the user try to intervene on the refrigerant circuit or disassemble the product. Always contact qualified personnel if necessary.

MONOSPLIT HYPER

CEILING



- Ideal for very large environments, thanks to the particularly wide air flow
- **100 m** Splitting distance
- Versatile installation thanks to drain pipe and refrigerant flexibility
- Polypropylene filter included

FDE 71-100-125-140 VH

Indoor unit model		FDE 71 VH	FDE 100 VH	FDE 125 VH	FDE 140 VH	
Outdoor unit model		FDC 71 VNX-W	FDC 100 VSX-W	FDC 125 VSX-W	FDC 140 VSX-W	
Type		DC-Inverter heat pump				
Nominal data						
Rated capacity (T=+35°C)	Cooling	kW	7.10 (3.20~8.00)	10.00 (3.50~11.20)	12.50 (3.50~14.00)	14.00 (3.50~16.00)
Rated power input (T=+35°C)		kW	1.87	2.33	3.34	4.08
Rated energy efficiency coefficient		EER ¹	3.80	4.29	3.75	3.43
Rated capacity (T=+7°C)	Heating	kW	8.00 (3.60~9.00)	11.20 (2.70~16.00)	14.00 (2.70~18.00)	16.00 (2.70~20.00)
Rated power input (T=+7°C)		kW	1.87	2.52	3.74	4.41
Rated energy performance coefficient		COP ¹	4.28	4.45	3.74	3.63
Seasonal data						
Design load (Pdesignc)	Cooling	kW	7.10	10.00	12.50	14.00
Seasonal energy efficiency index		SEER ²	6.58	7.00	6.53	6.29
Seasonal energy efficiency class		626/2011 ³	A++	A++	-	-
Annual energy consumption		kWh/y	378	501	-	-
Design load (Pdesignh) @ -10°C	Heating (average climate conditions)	kW	6.00	11.20	14.00	16.00
Seasonal energy efficiency index		SCOP ²	4.45	4.24	4.02	3.96
Seasonal energy efficiency class		626/2011 ³	A+	A+	-	-
Annual energy consumption		kWh/y	1889	3700	-	-
Electrical data						
Power supply	Outdoor unit	Ph-V-Hz	1-220~240V-50Hz	3-380~415V-50Hz		
Power cable		Type	3 x 4 mm ²	5 x 4 mm ²	5 x 4 mm ²	5 x 4 mm ²
Connection wires between I.U. and O.U.		nb.	4	4	4	4
Nominal absorbed current	Cooling	A	8.30	4.00	5.40	6.50
	Heating	A	8.30	4.20	6.10	7.20
Maximum current		A	19.10	14.00	14.00	14.00
Max power input		kW	4.11	8.90	8.90	8.90
Refrigerant circuit data						
Refrigerant ⁴	Type (GWP)	R32 (675)				
Quantity of refrigerant pre-charge	Kg	2.75	4	4	4	
Tons of CO ₂ equivalent	t	1.856	2.700	2.700	2.700	
Diameter of refrigerant pipings liquid/gas	mm (inches)	ø9.52 (3/8") - ø15.88(5/8")	ø9.52 (3/8") - ø15.88(5/8")	ø9.52 (3/8") - ø15.88(5/8")	ø9.52 (3/8") - ø15.88(5/8")	
Splitting distance	Min/Max	m	3/50	3/100	3/100	
Splitting level difference I.U./O.U.	O.U. above/O.U. below	m	30/15	50/15	50/15	
Splitting distance without additional charge		m	30	30	30	
Additional charge		g/m	54	54	54	
Indoor unit specifications						
Dimensions	LxDxH	mm	1320x690x210	1620x690x250	1620x690x250	1620x690x250
Net weight		Kg	33	43	43	43
Sound power level	Max	dB(A)	60	64	64	65
Sound pressure level	P-Hi/Hi/Me/Lo	dB(A)	47/41/37/32	48/43/38/34	48/45/40/35	49/45/40/36
Volume of air treated	P-Hi/Hi/Me/Lo	m ³ /h	1200/960/780/600	1920/1560/1260/990	1920/1740/1380/1020	2040/1740/1380/1080
Outdoor unit specifications						
Dimensions	LxDxH	mm	880(+88)x340x750	970x370x1300	970x370x1300	970x370x1300
Net weight		Kg	60	99	99	99
Sound power level	Max	dB(A)	66	67	70	71
Sound pressure level	Max	dB(A)	51	53	54	54
Volume of air treated	Max	m ³ /h	3600	6000	6000	6000
Operating range (outdoor temperature)	Cooling	°C	-15~+50			
	Heating	°C	-20~+20			
Accessories						
Wired control	RC-E5 (LCD) / RC-EX3A (touch) / RCH-E3 (simplified)					
IR remote control (KIT)	RCN-E-E3					
Optional parts						
Wi-Fi module	INWFIMH001R100					
Human sensor (KIT)	LB-E					
SUPERLINK II interface	SC-ADNA-E					

1. Value measured according to the harmonised standard EN 14511. 2. EU Regulation No. 206/2012 -- Value measured according to the harmonised standard EN 14825. 3. Delegated Regulation (EU) No 626/2011 regarding the new energy labelling of air conditioners. 4. Refrigerant leakage contributes to climate change. When released into the atmosphere, refrigerants with a lower global warming potential (GWP) contribute less to global warming than those with a higher GWP. This appliance contains a refrigerant with a GWP of 675. If 1 kg of this refrigerant fluid were released into the atmosphere, therefore, the impact on global warming would be 675 times higher than 1 kg of CO₂ over a period of 100 years. Under no circumstances should the user try to intervene on the refrigerant circuit or disassemble the product. Always contact qualified personnel if necessary.

MONOSPLIT HYPER

COLUMN



OPZIONALE

FD7 71-100-125-140 VH

- Ideal for restaurants, shops and offices applications, without false ceiling or high ceilings
- **100 m** Splitting distance
- Wide and powerful air flow
- Easy transport and installation
- The wired control has a alarm function in case of gas leakage. The gas sensor is on the base of the unit

Indoor unit model		FD7 71 VH	FD7 100 VH	FD7 125 VH	FD7 140 VH	
Outdoor unit model		FDC 71 VNX-W	FDC 100 VSX-W	FDC 125 VSX-W	FDC 140 VSX-W	
Type		DC-Inverter heat pump				
Control (included)		Wired control TOUCH with gas leak alarm				
Nominal data						
Rated capacity (T=+35°C)	Cooling	kW	7.10 (3.20~8.00)	10.00 (3.50~11.20)	12.50 (3.50~14.00)	14.00 (3.50~16.00)
Rated power input (T=+35°C)		kW	1.97	2.66	3.74	4.62
Rated energy efficiency coefficient		EER ¹	3.61	3.76	3.34	3.03
Rated capacity (T=+7°C)	Heating	kW	8.00 (3.60~9.00)	11.20 (2.70~16.00)	14.00 (2.70~18.00)	16.00 (2.70~20.00)
Rated power input (T=+7°C)		kW	2.21	2.95	3.88	4.70
Rated energy performance coefficient		COP ¹	3.62	3.80	3.61	3.41
Seasonal data						
Design load (Pdesignc)	Cooling	kW	7.10	10.00	12.50	14.00
Seasonal energy efficiency index		SEER ²	6.25	6.10	5.95	5.75
Seasonal energy efficiency class		626/2011 ³	A++	A++	-	-
Annual energy consumption		kWh/y	376	574	-	-
Design load (Pdesignh) @ -10°C	Heating (average climate conditions)	kW	6.00	11.20	14.00	16.00
Seasonal energy efficiency index		SCOP ²	4.03	3.84	3.78	3.65
Seasonal energy efficiency class		626/2011 ³	A+	A	-	-
Annual energy consumption		kWh/y	2085	4084	-	-
Electrical data						
Power supply	Outdoor unit	Ph-V-Hz	1-220~240V-50Hz	3-380~415V-50Hz		
Power cable		Type	3 x 4 mm ²	5 x 4 mm ²	5 x 4 mm ²	5 x 4 mm ²
Connection wires between I.U. and O.U.		nb.	4	4	4	4
Nominal absorbed current	Cooling	A	8.70	4.60	6.10	7.40
	Heating	A	9.90	5.00	6.40	7.70
Maximum current		A	19.10	14.00	14.00	14.00
Max power input		kW	4.11	8.90	8.90	8.90
Refrigerant circuit data						
Refrigerant ⁴		Type (GWP)	R32 (675)			
Quantity of refrigerant pre-charge		Kg	2.75	4	4	4
Tons of CO ₂ equivalent		t	1.856	2.700	2.700	2.700
Diameter of refrigerant pipings liquid/gas		mm (inches)	ø9.52 (3/8") - ø15.88(5/8")	ø9.52 (3/8") - ø15.88(5/8")	ø9.52 (3/8") - ø15.88(5/8")	ø9.52 (3/8") - ø15.88(5/8")
Splitting distance	Min/Max	m	-/50	3/100	3/100	3/100
Splitting level difference I.U./O.U.	O.U. above/O.U. below	m	30/15	50/15	50/15	50/15
Splitting distance without additional charge		m	30	30	30	30
Additional charge		g/m	54	54	54	54
Indoor unit specifications						
Dimensions	LxDxH	mm	600x329x1850	600x329x1850	600x329x1850	600x329x1850
Net weight		Kg	47	49	49	49
Sound power level	Max	dB(A)	55	65	67	67
Sound pressure level	P-Hi/Hi/Me/Lo	dB(A)	42/39/35/33	53/51/49/44	55/51/49/44	55/51/49/44
Volume of air treated	P-Hi/Hi/Me/Lo	m ³ /h	1080/960/840/720	1620/1560/1380/1140	1740/1560/1380/1140	1740/1560/1380/1140
Refrigerant gas leak detector			Integrated			
Outdoor unit specifications						
Dimensions	LxDxH	mm	880(+88)x340x750	970x370x1300	970x370x1300	970x370x1300
Net weight		Kg	60	99	99	99
Sound power level	Max	dB(A)	66	67	70	71
Sound pressure level	Max	dB(A)	51	53	54	54
Volume of air treated	Max	m ³ /h	3600	6000	6000	6000
Operating range (outdoor temperature)	Cooling	°C	-15~+50			
	Heating	°C	-20~+20			
Optional parts						
Wi-Fi module			INWFIMH001R100			
Human sensor (KIT)			LB-KIT2			
SUPERLINK II interface			SC-ADNA-E			
IR remote control (KIT)			RCN-KIT4-E2			

1. Value measured according to the harmonised standard EN 14511. 2. EU Regulation No. 206/2012 -- Value measured according to the harmonised standard EN 14825. 3. Delegated Regulation (EU) No 626/2011 regarding the new energy labelling of air conditioners. 4. Refrigerant leakage contributes to climate change. When released into the atmosphere, refrigerants with a lower global warming potential (GWP) contribute less to global warming than those with a higher GWP. This appliance contains a refrigerant with a GWP of 675. If 1 kg of this refrigerant fluid were released into the atmosphere, therefore, the impact on global warming would be 675 times higher than 1 kg of CO₂, over a period of 100 years. Under no circumstances should the user try to intervene on the refrigerant circuit or disassemble the product. Always contact qualified personnel if necessary.

MONOSPLIT HYPER

WALL



SRK 71-100 ZR-WF

- **339 mm**
Height
- **100 m**
Splitting distance
- **28 dB(A)**
Sound power level (7.10 kW),
maximum quiet
- Antibacterial treatment on fan
- The powerful air flow is realized with Jet technology
- Ideal for large living rooms and shops
- Equipped with dust and photocatalytic filters

Indoor unit model		SRK 71 ZR-WF		SRK 100 ZR-WF	
Outdoor unit model		FDC 71 VNX-W		FDC 100 VSX-W	
Type		DC-Inverter heat pump			
Control (included)		Remote control			
Nominal data					
Rated capacity (T=+35°C)	Cooling	kW	7.10 (3.20~8.00)	10.00 (3.50~11.20)	
Rated power input (T=+35°C)		kW	1.93	2.74	
Rated energy efficiency coefficient		EER1	3.68	3.65	
Rated capacity (T=+7°C)	Heating	kW	8.00 (3.60~9.00)	11.20 (2.70~16.00)	
Rated power input (T=+7°C)		kW	1.78	3.04	
Rated energy performance coefficient		COP1	4.49	3.69	
Seasonal data					
Design load (Pdesignc)	Cooling	kW	7.10	10.00	
Seasonal energy efficiency index		SEER2	6.80	6.54	
Seasonal energy efficiency class		626/20113	A++	A++	
Annual energy consumption		kWh/y	366	535	
Design load (Pdesignh) @ -10°C	Heating (average climate conditions)	kW	5.80	10.50	
Seasonal energy efficiency index		SCOP2	4.56	4.01	
Seasonal energy efficiency class		626/20113	A+	A	
Annual energy consumption		kWh/y	1782	3671	
Electrical data					
Power supply	Outdoor unit	Ph-V-Hz	1-220~240V-50Hz	3-380~415V-50Hz	
Power cable		Type	3 x 4 mm ²	5 x 4 mm ²	
Connection wires between I.U. and O.U.		nb.	4	4	
Nominal absorbed current	Cooling	A	8.60	4.70	
	Heating	A	7.90	5.10	
Maximum current		A	19.10	14.00	
Max power input		kW	4.11	8.90	
Refrigerant circuit data					
Refrigerant ⁴	Type (GWP)	R32 (675)			
Quantity of refrigerant pre-charge	Kg	2.75	4		
Tons of CO2 equivalent	t	1.856	2.700		
Diameter of refrigerant pipings liquid/gas	mm (inches)	ø9.52 (3/8") - ø15.88(5/8")		ø9.52 (3/8") - ø15.88(5/8")	
Splitting distance	Min/Max	m	3/50	3/100	
Max splitting level difference I.U./O.U.	O.U. above/O.U. below	m	30/15	50/15	
Splitting distance without additional charge		m	30	30	
Additional charge		g/m	54	54	
Indoor unit specifications					
Dimensions	LxDxH	mm	1197x262x339	1197x262x339	
Net weight		kg	15.5	16.5	
Sound power level	Max	dB(A)	60	63	
Sound pressure level (Hi/Mi/Lo/ULo)	Cooling	dB(A)	44/41/37/25	48/45/40/27	
	Heating		46/39/35/28	48/43/38/30	
Volume of air treated (Hi/Mi/Lo/ULo)	Cooling	m ³ /h	1230/1116/972/624	1470/1278/1056/624	
	Heating		1500/1188/1038/798	1650/1392/1146/816	
Outdoor unit specifications					
Dimensions	LxDxH	mm	880(+88)x340x750	970x370x1300	
Net weight		kg	60	99	
Sound power level	Max	dB(A)	66	67	
Sound pressure level	Max	dB(A)	51	53	
Volume of air treated	Max	m ³ /h	3600	6000	
Operating range (outdoor temperature)	Cooling	°C		-15~+50	
	Heating	°C		-20~+20	
Optional parts					
Wi-Fi module				Integrated	
Interface for home automation and wired control connection ⁵				SC-BIKN2-E	

1. Value measured according to the harmonised standard EN 14511. 2. EU Regulation No. 206/2012 -- Value measured according to the harmonised standard EN 14825. 3. Delegated Regulation (EU) No 626/2011 regarding the new energy labelling of air conditioners. 4. Refrigerant leakage contributes to climate change. When released into the atmosphere, refrigerants with a lower global warming potential (GWP) contribute less to global warming than those with a higher GWP. This appliance contains a refrigerant with a GWP of 675. If 1 kg of this refrigerant fluid were released into the atmosphere, therefore, the impact on global warming would be 675 times higher than 1 kg of CO₂, over a period of 100 years. Under no circumstances should the user try to intervene on the refrigerant circuit or disassemble the product. Always contact qualified personnel if necessary. 5. Home automation and optional protocols with dedicated interfaces: KNX, Modbus, BACnet.



SUPER SERIES



Design flexibility thanks to the small dimensions of the machines

Application solutions that meet the installation needs of both small and medium commercial spaces and industrial contexts

- **SEER up to 7.13**
Better seasonal efficiency
- **SCOP up to 4.60**
Better seasonal efficiency
- Compact dimensions up to 6HP
- Better installation flexibility:
splitting level difference I.U.-O.U. 50 m
- Wide availability of indoor units
- New PCB cooling system: a branch of the cooling circuit is passed to the base of the electronic board to avoid overheating



VNA-W = 1-PHASE
VSA-W= 3-PHASE

FDC 100 VNA-W/VSA-W (4HP)
FDC 125 VNA-W/VSA-W (5HP)
FDC 140 VNA-W/VSA-W (6HP)

FDC 200 VSA-W (8HP)
FDC 250 VSA-W (10HP)
FDC 280 VSA-W (12HP)

MONOSPLIT SUPER

CASSETTE 84X84

R32



FDT 100-125-140 VH
Standard white panel
T-PSA-5BW-E

FDT 100-125-140 VH
Anti-draft white panel
T-PSAE-5BW-E

FDT 100-125-140 VH
Standard black panel
T-PSA-5BB-E

FDT 100-125-140 VH
Black anti-draft panel
T-PSAE-5BB-E

Indoor unit model			FDT 100 VH	FDT 100 VH	FDT 125 VH	FDT 125 VH	FDT 140 VH	FDT 140 VH
Outdoor unit model			FDC 100 VNA-W	FDC 100 VSA-W	FDC 125 VNA-W	FDC 125 VSA-W	FDC 140 VNA-W	FDC 140 VSA-W
Type			DC-Inverter heat pump					
Nominal data								
Rated capacity (T=+35°C)	Cooling	kW	10.00 (4.00~11.20)		12.50 (5.00~14.00)		13.60 (5.00~14.50)	
Rated power input (T=+35°C)		kW	2.73		4.05		4.79	
Rated energy efficiency coefficient		EER ¹	3.66		3.09		2.84	
Rated capacity (T=+7°C)	Heating	kW	11.20 (4.00~12.50)		14.00 (4.00~16.00)		15.50 (4.00~16.50)	
Rated power input (T=+7°C)		kW	2.54		3.59		4.18	
Rated energy performance coefficient		COP ¹	4.41		3.90		3.71	
Seasonal data								
Design load (Pdesignc)	Cooling	kW	10.00		12.50		13.60	
Seasonal energy efficiency index		SEER ²	7.13		6.53		6.17	
Seasonal energy efficiency class		626/2011 ³	A++		-		-	
Annual energy consumption		kWh/y	491		-		-	
Design load (Pdesignh) @ -10°C	Heating (average climate conditions)	kW	8.50		14.00		15.50	
Seasonal energy efficiency index		SCOP ²	4.60		4.38		4.42	
Seasonal energy efficiency class		626/2011 ³	A++		-		-	
Annual energy consumption		kWh/y	2590		-		-	
Electrical data								
Power supply	Outdoor unit	Ph-V-Hz	1-220~240V-50Hz	3-380~415V-50Hz	1-220~240V-50Hz	3-380~415V-50Hz	1-220~240V-50Hz	3-380~415V-50Hz
Power cable		Type	3 x 6 mm ²	5 x 4 mm ²	3 x 6 mm ²	5 x 4 mm ²	3 x 6 mm ²	5 x 4 mm ²
Connection wires between I.U. and O.U.		nb.	4	4	4	4	4	4
Nominal absorbed current	Cooling	A	13.20	4.20	18.70	6.20	21.50	7.40
	Heating	A	12.40	3.90	16.80	5.50	18.50	6.60
Maximum current		A	24.00	15.00	24.00	15.00	24.00	15.00
Max power input		kW	6.40	10.20	6.40	10.20	6.40	10.20
Refrigerant circuit data								
Refrigerant ⁴		Type (GWP)	R32 (675)					
Q.ty of refrigerant pre-charge		Kg	3.3		3.3		3.3	
Tons of CO ₂ equivalent		t	2.228		2.228		2.228	
Diameter of refrigerant pipings liquid/gas		mm (inches)	ø9.52 (3/8") - ø15.88(5/8")		ø9.52 (3/8") - ø15.88(5/8")		ø9.52 (3/8") - ø15.88(5/8")	
Max splitting distance		m	50		50		50	
Splitting level difference I.U./O.U.	U.E. above/O.U. below	m	50/15		50/15		50/15	
Splitting distance without additional charge		m	30		30		30	
Additional charge		g/m	54		54		54	
Indoor unit specifications								
Dimensions	LxDxH	mm	840x840x298		840x840x298		840x840x298	
Net weight		Kg	25		25		25	
Sound power level	Max	dB(A)	62		64		64	
Sound pressure level (P-Hi/Hi/Mi/Lo)	Cooling	dB(A)	47/39/36/30		48/41/39/31		48/42/39/32	
	Heating	dB(A)	47/39/36/29		48/41/38/31		48/41/38/31	
Volume of air treated	P-Hi/Hi/Me/Lo	m ³ /h	2220/1560/1380/1020		2280/1680/1500/1080		2280/1740/1560/1140	
Outdoor unit specifications								
Dimensions	LxDxH	mm	970x370x845		970x370x845		970x370x845	
Net weight		Kg	77	78	77	78	77	78
Sound power level	Max	dB(A)	70		71		73	
Sound pressure level	Max	dB(A)	55		56		58	
Volume of air treated	Max	m ³ /h	4500		4500		4500	
Operating range (outdoor temperature)	Cooling	°C	-15~+50		-15~+50		-15~+50	
	Heating	°C	-20~+20		-20~+20		-20~+20	
Accessories								
Decorative panel					T-PSA-5BW-E (white) / T-PSA-5BB-E (black)			
Panel size	LxDxH	mm	950x950x35		950x950x35		950x950x35	
Net weight		Kg	5		5		5	
Wired control	RC-E5 (LCD) / RC-EX3A (touch) / RCH-E3 (simplified)							
IR remote control (corner KIT)	RCN-T-5BW-E2 (white) / RCN-T-5BB-E2 (black)							
Optional parts								
Wi-Fi module	INWFIMH001R100							
Human sensor (corner KIT)	LB-T-5BW-E (white) / LB-T-5BB-E (black)							
SUPERLINK II interface	SC-ADNA-E							
Anti-draft panel	T-PSAE-5BW-E (white) / T-PSAE-5BB-E (black)							

1. Value measured according to the harmonised standard EN 14511. 2. EU Regulation No. 206/2012 -- Value measured according to the harmonised standard EN 14825. 3. Delegated Regulation (EU) No 626/2011 regarding the new energy labelling of air conditioners. 4. Refrigerant leakage contributes to climate change. When released into the atmosphere, refrigerants with a lower global warming potential (GWP) contribute less to global warming than those with a higher GWP. This appliance contains a refrigerant with a GWP of 675. If 1 kg of this refrigerant fluid were released into the atmosphere, therefore, the impact on global warming would be 675 times higher than 1 kg of CO₂ over a period of 100 years. Under no circumstances should the user try to intervene on the refrigerant circuit or disassemble the product. Always contact qualified personnel if necessary.

MONOSPLIT SUPER

DUCTED MEDIUM STATIC PRESSURE ADJUSTABLE

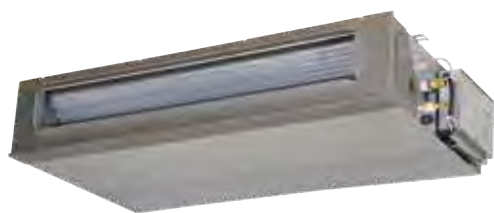

FDUM 100-125-140 VH

- **max 100**
Fan static pressure
- Unit with bottom or rear air intake
- **280 mm**
Height
- **50 m**
Splitting distance
- ESP function: automatic maintenance of the air flow rate as flow resistance varies
- Filter not included
- Compatible with **AIRZONE** systems

Indoor unit model			FDUM 100 VH	FDUM 100 VH	FDUM 125 VH	FDUM 125 VH	FDUM 140 VH	FDUM 140 VH
Outdoor unit model			FDU 100 VNA-W	FDC 100 VSA-W	FDC 125 VNA-W	FDC 125 VSA-W	FDC 140 VNA-W	FDC 140 VSA-W
Type			DC-Inverter heat pump					
Nominal data								
Rated capacity (T=+35°C)	Cooling	kW	10.00 (4.00~11.20)		12.50 (5.00~14.00)		13.60 (5.00~14.50)	
Rated power input (T=+35°C)		kW	2.99		4.36		5.13	
Rated energy efficiency coefficient		EER ¹	3.35		2.87		2.65	
Rated capacity (T=+7°C)	Heating	kW	11.20 (4.00~12.50)		14.00 (4.00~16.00)		15.50 (4.00~16.50)	
Rated power input (T=+7°C)		kW	2.66		3.69		4.21	
Rated energy performance coefficient		COP ¹	4.21		3.79		3.68	
Seasonal data								
Design load (Pdesignc)	Cooling	kW	10.00		12.50		13.60	
Seasonal energy efficiency index		SEER ²	6.11		5.57		5.30	
Seasonal energy efficiency class		626/2011 ³	A++		-		-	
Annual energy consumption		kWh/y	574		-		-	
Design load (Pdesignh) @ -10°C	Heating (average climate conditions)	kW	8.50		14.00		15.50	
Seasonal energy efficiency index		SCOP ²	4.19		4.13		4.01	
Seasonal energy efficiency class		626/2011 ³	A+		-		-	
Annual energy consumption		kWh/y	2843		-		-	
Electrical data								
Power supply	Outdoor unit	Ph-V-Hz	1-220~240V-50Hz	3-380~415V-50Hz	1-220~240V-50Hz	3-380~415V-50Hz	1-220~240V-50Hz	3-380~415V-50Hz
Power cable		Type	3 x 6 mm ²	5 x 4 mm ²	3 x 6 mm ²	5 x 4 mm ²	3 x 6 mm ²	5 x 4 mm ²
Connection wires between I.U. and O.U.		nb.	4	4	4	4	4	4
Nominal absorbed current	Cooling	A	14.30	4.60	20.40	6.80	23.70	8.10
	Heating	A	12.70	4.10	17.80	5.90	20.30	6.80
Maximum current		A	26.00	17.00	26.00	17.00	27.00	18.00
Max power input		kW	6.40	10.20	6.40	10.20	6.40	10.20
Refrigerant circuit data								
Refrigerant ⁴		Type (GWP)	R32 (675)					
Q.ty of refrigerant pre-charge		Kg	3.3		3.3		3.3	
Tons of CO2 equivalent		t	2.228		2.228		2.228	
Diameter of refrigerant pipings liquid/gas		mm (inches)	ø9.52 (3/8") - ø15.88(5/8")		ø9.52 (3/8") - ø15.88(5/8")		ø9.52 (3/8") - ø15.88(5/8")	
Max splitting distance		m	50		50		50	
Splitting level difference I.U./O.U.	O.U. above/O.U. below	m	50/15		50/15		50/15	
Splitting distance without additional charge		m	30		30		30	
Additional charge		g/m	54		54		54	
Indoor unit specifications								
Dimensions	LxDxH	mm	1370x740x280		1370x740x280		1370x740x280	
Net weight		Kg	54		54		54	
Sound power level	Max	dB(A)	65		67		70	
Sound pressure level	P-Hi/Hi/Me/Lo	dB(A)	44/38/36/30		45/40/34/29		47/40/35/30	
Volume of air treated	P-Hi/Hi/Me/Lo	m ³ /h	2160/1680/1500/1140		2340/1920/1560/1200		2880/2100/1680/1320	
Fan static pressure	Std/Max	Pa	60/100		60/100		60/100	
Outdoor unit specifications								
Dimensions	LxDxH	mm	970x370x845		970x370x845		970x370x845	
Net weight		Kg	77	78	77	78	77	78
Sound power level	Max	dB(A)	70		71		73	
Sound pressure level	Max	dB(A)	55		56		58	
Volume of air treated	Max	m ³ /h	4500		4500		4500	
Operating range (outdoor temperature)	Cooling	°C			-15~+50			
	Heating	°C			-20~+20			
Accessories								
Wired control			RC-E5 (LCD) / RC-EX3A (touch) / RC-EX23A (touch + zone control) / RCH-E3 (simplified)					
IR remote control (KIT)			RCN-KIT4-E2					
Optional parts								
Wi-Fi module			INWFIMH001R100					
Human sensor (KIT)			LB-KIT2					
SUPERLINK II interface			SC-ADNA-E					
Recovery filter (KIT)			UM-FL3EF					

1. Value measured according to the harmonised standard EN 14511. 2. EU Regulation No. 206/2012 -- Value measured according to the harmonised standard EN 14825. 3. Delegated Regulation (EU) No 626/2011 regarding the new energy labelling of air conditioners. 4. Refrigerant leakage contributes to climate change. When released into the atmosphere, refrigerants with a lower global warming potential (GWP) contribute less to global warming than those with a higher GWP. This appliance contains a refrigerant with a GWP of 675. If 1 kg of this refrigerant fluid were released into the atmosphere, therefore, the impact on global warming would be 675 times higher than 1 kg of CO₂ over a period of 100 years. Under no circumstances should the user try to intervene on the refrigerant circuit or disassemble the product. Always contact qualified personnel if necessary.

MONOSPLIT SUPER

DUCTED HIGH STATIC PRESSURE ADJUSTABLE



FDU 100-125-140 VH

- **max 200**
Fan static pressure
- Unit with bottom or rear air intake
- **280 mm**
Height
- **50 m**
Splitting distance
- ESP function: automatic maintenance of the air flow rate as flow resistance varies
- Filter not included
- Compatible with **AIRZONE** systems

Indoor unit model			FDU 100 VH	FDU 100 VH	FDU 125 VH	FDU 125 VH	FDU 140 VH	FDU 140 VH
Outdoor unit model			FDC 100 VNA-W	FDC 100 VSA-W	FDC 125 VNA-W	FDC 125 VSA-W	FDC 140 VNA-W	FDC 140 VSA-W
Type		DC-Inverter heat pump						
Nominal data								
Rated capacity (T=+35°C)	Cooling	kW	10.00 (4.00~11.20)		12.50 (5.00~14.00)		13.60 (5.00~14.50)	
Rated power input (T=+35°C)		kW	2.99		4.36		5.13	
Rated energy efficiency coefficient		EER ¹	3.35		2.87		2.65	
Rated capacity (T=+7°C)	Heating	kW	11.20 (4.00~12.50)		14.00 (4.00~16.00)		15.50 (4.00~16.50)	
Rated power input (T=+7°C)		kW	2.66		3.69		4.21	
Rated energy performance coefficient		COP ¹	4.21		3.79		3.68	
Seasonal data								
Design load (Pdesignc)	Cooling	kW	10.00		12.50		13.60	
Seasonal energy efficiency index		SEER ²	6.11		5.57		5.30	
Seasonal energy efficiency class		626/2011 ³	A++		-		-	
Annual energy consumption		kWh/y	574		-		-	
Design load (Pdesignh) @ -10°C	Heating (average climate conditions)	kW	8.50		14.00		15.50	
Seasonal energy efficiency index		SCOP ²	4.19		4.13		4.01	
Seasonal energy efficiency class		626/2011 ³	A+		-		-	
Annual energy consumption		kWh/y	2843		-		-	
Electrical data								
Power supply	Outdoor unit	Ph-V-Hz	1-220~240V-50Hz	3-380~415V-50Hz	1-220~240V-50Hz	3-380~415V-50Hz	1-220~240V-50Hz	3-380~415V-50Hz
Power cable		Type	3 x 6 mm ²	5 x 4 mm ²	3 x 6 mm ²	5 x 4 mm ²	3 x 6 mm ²	5 x 4 mm ²
Connection wires between I.U. and O.U.		nb.	4	4	4	4	4	4
Nominal absorbed current	Cooling	A	14.30	4.60	20.40	6.80	23.70	8.10
	Heating	A	12.70	4.10	17.80	5.90	20.30	6.80
Maximum current		A	26.00	17.00	26.00	17.00	27.00	18.00
Max power input		kW	6.40	10.20	6.40	10.20	6.40	10.20
Refrigerant circuit data								
Refrigerant ⁴		Type (GWP)	R32 (675)					
Q.ty of refrigerant pre-charge		Kg	3.3		3.3		3.3	
Tons of CO2 equivalent		t	2.228		2.228		2.228	
Diameter of refrigerant pipings liquid/gas		mm (inches)	ø9.52 (3/8") - ø15.88(5/8")		ø9.52 (3/8") - ø15.88(5/8")		ø9.52 (3/8") - ø15.88(5/8")	
Max splitting distance		m	50		50		50	
Splitting level difference I.U./O.U.	O.U. above/O.U. below	m	50/15		50/15		50/15	
Splitting distance without additional charge		m	30		30		30	
Additional charge		g/m	54		54		54	
Indoor unit specifications								
Dimensions	LxDxH	mm	1370x740x280		1370x740x280		1370x740x280	
Net weight		Kg	54		54		54	
Sound power level	Max	dB(A)	65		67		70	
Sound pressure level	P-Hi/Hi/Me/Lo	dB(A)	44/38/36/30		45/40/34/29		47/40/35/30	
Volume of air treated	P-Hi/Hi/Me/Lo	m ³ /h	2160/1680/1500/1140		2340/1920/1560/1200		2880/2100/1680/1320	
Fan static pressure	Std/Max	Pa	60/200		60/200		60/200	
Outdoor unit specifications								
Dimensions	LxDxH	mm	970x370x845		970x370x845		970x370x845	
Net weight		Kg	77	78	77	78	77	78
Sound power level	Max	dB(A)	70		71		73	
Sound pressure level	Max	dB(A)	55		56		58	
Volume of air treated	Max	m ³ /h	4500		4500		4500	
Operating range (outdoor temperature)	Cooling	°C			-15~+50			
	Heating	°C			-20~+20			
Accessories								
Wired control			RC-E5 (LCD) / RC-EX3A (touch) / RC-EX23A (touch + zone control) / RCH-E3 (simplified)					
IR remote control (KIT)			RCN-KIT4-E2					
Optional parts								
Wi-Fi module			INWFIMH001R100					
Human sensor (KIT)			LB-KIT2					
SUPERLINK II interface			SC-ADNA-E					

1. Value measured according to the harmonised standard EN 14511. 2. EU Regulation No. 206/2012 -- Value measured according to the harmonised standard EN 14825. 3. Delegated Regulation (EU) No 626/2011 regarding the new energy labelling of air conditioners. 4. Refrigerant leakage contributes to climate change. When released into the atmosphere, refrigerants with a lower global warming potential (GWP) contribute less to global warming than those with a higher GWP. This appliance contains a refrigerant with a GWP of 675. If 1 kg of this refrigerant fluid were released into the atmosphere, therefore, the impact on global warming would be 675 times higher than 1 kg of CO₂ over a period of 100 years. Under no circumstances should the user try to intervene on the refrigerant circuit or disassemble the product. Always contact qualified personnel if necessary.

MONOSPLIT SUPER

DUCTED HIGH STATIC PRESSURE ADJUSTABLE



- **max 200**
Fan static pressure
- Unit with bottom or rear air intake
- **70 m**
Splitting distance (20.00~25.00 kW)
- ESP function: automatic maintenance of the air flow rate as flow resistance varies

FDU 200-250-280 VH

Indoor unit model		FDU 200 VH	FDU 250 VH	FDU 280 VH	
Outdoor unit model		FDC 200 VSA-W	FDC 250 VSA-W	FDC 280 VSA-W	
Type		DC-Inverter heat pump			
Nominal data					
Rated capacity (T=+35°C)	Cooling	kW	20.00 (7.20~22.40)	25.00 (7.20~28.00)	27.00 (6.90~31.50)
Rated power input (T=+35°C)		kW	6.15	8.25	9.15
Rated energy efficiency coefficient		EER ¹	3.25	3.03	2.95
Rated capacity (T=+7°C)	Heating	kW	22.40 (6.50~25.00)	28.00 (6.70~31.50)	30.00 (6.90~33.50)
Rated power input (T=+7°C)		kW	5.67	7.55	9.12
Rated energy performance coefficient		COP ¹	3.95	3.75	3.29
Seasonal data					
Design load (Pdesignc)	Cooling	kW	20.00	25.00	27.00
Seasonal energy efficiency index		SEER ²	5.90	4.89	4.93
Seasonal energy efficiency class		626/2011 ³	-	-	-
Annual energy consumption		kWh/y	-	-	-
Design load (Pdesignh) @ -10°C	Heating (average climate conditions)	kW	22.40	28.00	30.00
Seasonal energy efficiency index		SCOP ²	3.55	3.54	3.70
Seasonal energy efficiency class		626/2011 ³	-	-	-
Annual energy consumption		kWh/y	-	-	-
Electrical data					
Power supply	Outdoor unit	Ph-V-Hz	3-380~415V-50Hz		
Power cable		Type	5 x 6 mm ²	5 x 6 mm ²	5 x 6 mm ²
Connection wires between I.U. and O.U.		nb.	4	4	4
Nominal absorbed current	Cooling	A	9.80	12.70	14.20
	Heating	A	8.90	11.60	14.00
Maximum current		A	23.00	25.00	25.00
Max power input		kW	12.00	11.20	11.40
Refrigerant circuit data					
Refrigerant ⁴		Type (GWP)	R32 (675)		
Q.ty of refrigerant pre-charge		Kg	4.3	5.1	5.6
Tons of CO2 equivalent		t	2.903	3.443	3.780
Diameter of refrigerant pipings liquid/gas		mm (inches)	ø9.52 (3/8") - ø22.2 (7/8") ⁵	ø12.7 (1/2") - ø22.2 (7/8") ⁵	ø12.7 (1/2") - ø22.2 (7/8") ⁵
Max splitting distance		m	70	70	60
Splitting level difference I.U./O.U.	O.U. above/O.U. below	m	50/15	50/15	50/15
Splitting distance without additional charge		m	30	30	30
Additional charge		g/m	Please consult the Technical Manual ⁵		
Indoor unit specifications					
Dimensions	LxDxH	mm	1600x893x379	1600x893x379	1600x893x379
Net weight		Kg	88	88	88
Sound power level	Max	dB(A)	78	78	78
Sound pressure level	P-Hi/Hi/Me/Lo	dB(A)	52/50/47/45	52/50/47/45	52/50/47/45
Volume of air treated	P-Hi/Hi/Me/Lo	m ³ /h	4800/4320/3840/3360	4800/4320/3840/3360	4800/4320/3840/3360
Fan static pressure	Std/Max	Pa	72/200	72/200	72/200
Outdoor unit specifications					
Dimensions	LxDxH	mm	970x370x1505	970x370x1505	970x370x1505
Net weight		Kg	144	145	155
Sound power level	Max	dB(A)	74	75	77
Sound pressure level	Max	dB(A)	59	62	63
Volume of air treated	Max	m ³ /h	8880	9180	8400
Operating range (outdoor temperature)	Cooling	°C	-15~+50		
	Heating	°C	-20~+20		
Accessories					
Wired control			RC-E5 (LCD) / RC-EX3A (touch) / RC-EX23A (touch + zone control) / RCH-E3 (simplified)		
IR remote control (KIT)			RCN-KIT4-E2		
Optional parts					
Wi-Fi module			INWFIMH001R100		
Human sensor (KIT)			LB-KIT2		
SUPERLINK II interface			SC-ADNA-E		

1. Value measured according to the harmonised standard EN 14511. 2. EU Regulation No. 206/2012 -- Value measured according to the harmonised standard EN 14825. 3. Delegated Regulation (EU) No 626/2011 regarding the new energy labelling of air conditioners. 4. Refrigerant leakage contributes to climate change. When released into the atmosphere, refrigerants with a lower global warming potential (GWP) contribute less to global warming than those with a higher GWP. This appliance contains a refrigerant with a GWP of 675. If 1 kg of this refrigerant fluid were released into the atmosphere, therefore, the impact on global warming would be 675 times higher than 1 kg of CO₂ over a period of 100 years. Under no circumstances should the user try to intervene on the refrigerant circuit or disassemble the product. Always contact qualified personnel if necessary. 5. The piping diameter and the additional refrigerant charge change depending on the splitting distance. For details, consult the technical manual.

MONOSPLIT SUPER

CEILING



- Ideal for very large environments, thanks to the particularly wide air flow
- **50 m** Splitting distance
- Versatile installation thanks to drain pipe and refrigerant flexibility
- Polypropylene filter included

FDE 100-125-140 VH

Indoor unit model	FDE 100 VH		FDE 125 VH		FDE 140 VH			
Outdoor unit model	FDC 100 VNA-W		FDC 125 VNA-W		FDC 140 VNA-W			
Type	DC-Inverter heat pump							
Nominal data								
Rated capacity (T _i =+35°C)	Cooling	kW	10.00 (4.00~11.20)		12.50 (5.00~14.00)		13.60 (5.00~14.50)	
Rated power input (T _i =+35°C)		kW	2.85		4.45		5.05	
Rated energy efficiency coefficient		EER ¹	3.51		2.81		2.69	
Rated capacity (T _i =+7°C)	Heating	kW	11.20 (4.00~12.50)		14.00 (4.00~16.00)		15.50 (4.00~16.50)	
Rated power input (T _i =+7°C)		kW	2.54		3.74		4.18	
Rated energy performance coefficient		COP ¹	4.41		3.74		3.71	
Seasonal data								
Design load (P _{designg})	Cooling	kW	10.00		12.50		13.60	
Seasonal energy efficiency index		SEER ²	6.67		6.03		5.76	
Seasonal energy efficiency class		626/2011 ³	A++		-		-	
Annual energy consumption		kWh/y	525		-		-	
Design load (P _{designh}) @ -10°C	Heating (average climate conditions)	kW	8.50		14.00		15.50	
Seasonal energy efficiency index		SCOP ²	4.31		4.30		4.24	
Seasonal energy efficiency class		626/2011 ³	A+		-		-	
Annual energy consumption		kWh/y	2764		-		-	
Electrical data								
Power supply	Outdoor unit	Ph-V-Hz	1-220~240V-50Hz	3-380~415V-50Hz	1-220~240V-50Hz	3-380~415V-50Hz	1-220~240V-50Hz	3-380~415V-50Hz
Power cable		Type	3 x 6 mm ²	5 x 4 mm ²	3 x 6 mm ²	5 x 4 mm ²	3 x 6 mm ²	5 x 4 mm ²
Connection wires between I.U. and O.U.		nb.	4	4	4	4	4	4
Nominal absorbed current	Cooling	A	13.80	4.60	20.40	6.90	22.20	7.80
	Heating	A	12.40	4.00	17.50	5.90	18.40	6.50
Maximum current		A	24.00	15.00	24.00	15.00	24.00	15.00
Max power input		kW	6.40	10.20	6.40	10.20	6.40	10.20
Refrigerant circuit data								
Refrigerant ⁴		Type (GWP)	R32 (675)					
Q.ty of refrigerant pre-charge		Kg	3.3		3.3		3.3	
Tons of CO ₂ equivalent		t	2.228		2.228		2.228	
Diameter of refrigerant pipings liquid/gas		mm (inches)	ø9.52 (3/8") - ø15.88(5/8")		ø9.52 (3/8") - ø15.88(5/8")		ø9.52 (3/8") - ø15.88(5/8")	
Max splitting distance		m	50		50		50	
Splitting level difference I.U./O.U.	O.U. above/O.U. below	m	50/15		50/15		50/15	
Splitting distance without additional charge		m	30		30		30	
Additional charge		g/m	54		54		54	
Indoor unit specifications								
Dimensions	LxDxH	mm	1620x690x250		1620x690x250		1620x690x250	
Net weight		Kg	43		43		43	
Sound power level	Max	dB(A)	64		64		65	
Sound pressure level	P-Hi/Hi/Me/Lo	dB(A)	48/43/38/34		48/45/40/35		49/45/40/36	
Volume of air treated	P-Hi/Hi/Me/Lo	m ³ /h	1920/1560/1260/990		1920/1740/1380/1020		2040/1740/1380/1080	
Outdoor unit specifications								
Dimensions	LxDxH	mm	970x370x845		970x370x845		970x370x845	
Net weight		Kg	77	78	77	78	77	78
Sound power level	Max	dB(A)	70		71		73	
Sound pressure level	Max	dB(A)	55		56		58	
Volume of air treated	Max	m ³ /h	4500		4500		4500	
Operating range (outdoor temperature)	Cooling	°C	-15~+50					
	Heating	°C	-20~+20					
Accessories								
Wired control	RC-E5 (LCD) / RC-EX3A (touch) / RCH-E3 (simplified)							
IR remote control (KIT)	RCN-E-E3							
Optional parts								
Wi-Fi module	INWFIMH1001R100							
Human sensor (KIT)	LB-E							
SUPERLINK II interface	SC-ADNA-E							

1. Value measured according to the harmonised standard EN 14511. 2. EU Regulation No. 206/2012 -- Value measured according to the harmonised standard EN 14825. 3. Delegated Regulation (EU) No 626/2011 regarding the new energy labelling of air conditioners. 4. Refrigerant leakage contributes to climate change. When released into the atmosphere, refrigerants with a lower global warming potential (GWP) contribute less to global warming than those with a higher GWP. This appliance contains a refrigerant with a GWP of 675. If 1 kg of this refrigerant fluid were released into the atmosphere, therefore, the impact on global warming would be 675 times higher than 1 kg of CO₂, over a period of 100 years. Under no circumstances should the user try to intervene on the refrigerant circuit or disassemble the product. Always contact qualified personnel if necessary.

MONOSPLIT SUPER

COLUMN



FDf 100-125-140 VH

- Ideal for restaurants, shops and offices applications, without false ceiling or high ceilings
- **50 m**
Splitting distance
- Wide and powerful air flow
- Easy transport and installation
- The wired control has a alarm function in case of gas leakage. The gas sensor is on the base of the unit

Indoor unit model			FDf 100 VH	FDf 100 VH	FDf 125 VH	FDf 125 VH	FDf 140 VH	FDf 140 VH
Outdoor unit model			FDf 100 VNA-W	FDf 100 VSA-W	FDf 125 VNA-W	FDf 125 VSA-W	FDf 140 VNA-W	FDf 140 VSA-W
Type			DC-Inverter heat pump					
Control (included)			Wired control TOUCH with gas leak alarm					
Nominal data								
Rated capacity (T=+35°C)	Cooling	kW	10.00 (4.00~11.20)		12.50 (5.00~14.00)		13.60 (5.00~14.50)	
		kW	3.08		4.65		5.35	
		EER1	3.25		2.69		2.54	
Rated capacity (T=+7°C)	Heating	kW	11.20 (4.00~12.50)		14.00 (4.00~16.00)		15.50 (4.00~16.50)	
		kW	2.94		4.10		4.98	
		COP1	3.81		3.42		3.11	
Seasonal data								
Design load (Pdesignc)	Cooling	kW	10.00		12.50		13.60	
		SEER2	5.76		5.28		5.13	
		626/20113	A++		-		-	
Annual energy consumption	Heating (average climate conditions)	kWh/y	608		-		-	
		Design load (Pdesignh) @ -10°C	8.50		14.00		15.50	
		SCOP2	4.00		3.89		3.92	
Seasonal energy efficiency class	626/20113	A+		-		-		
		kWh/y	2973		-		-	
Electrical data								
Power supply	Outdoor unit	Ph-V-Hz	1-220~240V-50Hz	3-380~415V-50Hz	1-220~240V-50Hz	3-380~415V-50Hz	1-220~240V-50Hz	3-380~415V-50Hz
Power cable		Type	3 x 6 mm ²	5 x 4 mm ²	3 x 6 mm ²	5 x 4 mm ²	3 x 6 mm ²	5 x 4 mm ²
Connection wires between I.U. and O.U.		nb.	4	4	4	4	4	4
Nominal absorbed current	Cooling	A	14.90	4.80	21.50	7.20	24.00	8.40
	Heating	A	14.40	4.60	19.20	6.30	22.10	7.90
Maximum current	A	24.00	15.00	24.00	15.00	24.00	15.00	
Max power input	kW	6.40	10.20	6.40	10.20	6.40	10.20	
Refrigerant circuit data								
Refrigerant ⁴	Type (GWP)	R32 (675)						
Quantity of refrigerant pre-charge	Kg	3.3		3.3		3.3		
Tons of CO2 equivalent	t	2.228		2.228		2.228		
Diameter of refrigerant pipings liquid/gas	mm (inches)	ø9.52 (3/8") - ø15.88(5/8")		ø9.52 (3/8") - ø15.88(5/8")		ø9.52 (3/8") - ø15.88(5/8")		
Max splitting distance	m	50		50		50		
Splitting level difference I.U./O.U.	O.U. above/O.U. below	m		50/15		50/15		
Splitting distance without additional charge	m	30		30		30		
Additional charge	g/m	54		54		54		
Indoor unit specifications								
Dimensions	LxDxH	mm	600x329x1850		600x329x1850		600x329x1850	
Net weight	Kg	49		49		49		
Sound power level	Max	dB(A)	65		67		67	
Sound pressure level	P-Hi/Hi/Me/Lo	dB(A)	53/51/49/44		55/51/49/44		55/51/49/44	
Volume of air treated	P-Hi/Hi/Me/Lo	m ³ /h	1620/1560/1380/1140		1740/1560/1380/1140		1740/1560/1380/1140	
Refrigerant gas leak detector	Integrated							
Outdoor unit specifications								
Dimensions	LxDxH	mm	970x370x845		970x370x845		970x370x845	
Net weight	Kg	77	78	77	78	77	78	
Sound power level	Max	dB(A)	70		71		73	
Sound pressure level	Max	dB(A)	55		56		58	
Volume of air treated	Max	m ³ /h	4500		4500		4500	
Operating range (outdoor temperature)	Cooling	°C	-15~+50					
	Heating	°C	-20~+20					
Optional parts								
Wi-Fi module					INWFIMHI001R100			
Human sensor (KIT)					LB-KIT2			
SUPERLINK II interface					SC-ADNA-E			
IR remote control (KIT)					RCN-KIT4-E2			

1. Value measured according to the harmonised standard EN 14511. 2. EU Regulation No. 206/2012 -- Value measured according to the harmonised standard EN 14825. 3. Delegated Regulation (EU) No 626/2011 regarding the new energy labelling of air conditioners. 4. Refrigerant leakage contributes to climate change. When released into the atmosphere, refrigerants with a lower global warming potential (GWP) contribute less to global warming than those with a higher GWP. This appliance contains a refrigerant with a GWP of 675. If 1 kg of this refrigerant fluid were released into the atmosphere, therefore, the impact on global warming would be 675 times higher than 1 kg of CO₂ over a period of 100 years. Under no circumstances should the user try to intervene on the refrigerant circuit or disassemble the product. Always contact qualified personnel if necessary.

MONOSPLIT SUPER

WALL



SRK 100 ZR-WF

- **339 mm**
Height
- **50 m**
Splitting distance
- **27 dB(A)**
Sound power level, maximum quiet
- Antibacterial treatment on fan
- The powerful air flow is realized with Jet technology
- Ideal for large living rooms and shops
- Equipped with dust and photocatalytic filter

Indoor unit model		SRK 100 ZR-WF		SRK 100 ZR-WF	
Outdoor unit model		FDC 100 VNA-W		FDC 100 VSA-W	
Type		DC-Inverter heat pump			
Control (included)		Remote control			
Nominal data					
Rated capacity (T=+35°C)	Cooling	kW	10.00 (4.00~11.20)		
Rated power input (T=+35°C)		kW	3.19		
Rated energy efficiency coefficient		EER1	3.13		
Rated capacity (T=+7°C)	Heating	kW	11.20 (4.00~12.50)		
Rated power input (T=+7°C)		kW	3.04		
Rated energy performance coefficient		COP1	3.68		
Seasonal data					
Design load (Pdesignc)	Cooling	kW	10.00		
Seasonal energy efficiency index		SEER2	6.13		
Seasonal energy efficiency class		626/20113	A++		
Annual energy consumption		kWh/y	571		
Design load (Pdesignh) @ -10°C	Heating (average climate conditions)	kW	8.50		
Seasonal energy efficiency index		SCOP2	4.33		
Seasonal energy efficiency class		626/20113	A+		
Annual energy consumption		kWh/y	2746		
Electrical data					
Power supply	Outdoor unit	Ph-V-Hz	1-220~240V-50Hz		3-380~415V-50Hz
Power cable		Type	3 x 6 mm ²		5 x 4 mm ²
Connection wires between I.U. and O.U.		nb.	4		4
Nominal absorbed current	Cooling	A	14.30		4.80
	Heating	A	13.60		4.60
Maximum current		A	24.00		15.00
Max power input		kW	6.40		10.20
Refrigerant circuit data					
Refrigerant ⁴	Type (GWP)	R32 (675)			
Quantity of refrigerant pre-charge	kg	3.3			
Tons of CO2 equivalent	t	2.228			
Diameter of refrigerant pipings liquid/gas	mm (inches)	ø9.52 (3/8") - ø15.88(5/8")			
Max splitting distance	m	50			
Splitting level difference I.U./O.U.	O.U. above/O.U. below	m	50/15		
Splitting distance without additional charge	m	30			
Additional charge	g/m	54			
Indoor unit specifications					
Dimensions	LxDxH	mm	1197x262x339		
Net weight	kg	16.5			
Sound power level	Max	dB(A)	63		
Sound pressure level (Hi/Mi/Lo/U/Lo)	Cooling	dB(A)	48/45/40/27		
	Heating	dB(A)	48/43/38/30		
Volume of air treated (Hi/Mi/Lo/U/Lo)	Cooling	m ³ /h	1470/1278/1056/624		
	Heating	m ³ /h	1650/1392/1146/816		
Outdoor unit specifications					
Dimensions	LxDxH	mm	970x370x845		
Net weight	kg	77		78	
Sound power level	Max	dB(A)	70		
Sound pressure level	Max	dB(A)	55		
Volume of air treated	Max	m ³ /h	4500		
Operating range (outdoor temperature)	Cooling	°C	-15~+50		
	Heating	°C	-20~+20		
Optional parts					
Wi-Fi module					Included
Interface for home automation connection and wired control ⁵					SC-BIKN2-E

1. Value measured according to the harmonised standard EN 14511. 2. EU Regulation No. 206/2012 -- Value measured according to the harmonised standard EN 14825. 3. Delegated Regulation (EU) No 626/2011 regarding the new energy labelling of air conditioners. 4. Refrigerant leakage contributes to climate change. When released into the atmosphere, refrigerants with a lower global warming potential (GWP) contribute less to global warming than those with a higher GWP. This appliance contains a refrigerant with a GWP of 675. If 1 kg of this refrigerant fluid were released into the atmosphere, therefore, the impact on global warming would be 675 times higher than 1 kg of CO₂ over a period of 100 years. Under no circumstances should the user try to intervene on the refrigerant circuit or disassemble the product. Always contact qualified personnel if necessary. 5. Home automation and optional protocols with dedicated interfaces: KNX, Modbus, BACnet.

SMART SERIES



Performance intelligence in compact dimensions

■ **4 capacities**

1-Phase 3~5HP = 7.10~12.10 kW

- Refrigerant pipe diameter, weight and overall dimensions extremely reduced compared to the 7.10 and 10.00 kW outdoor units of the Super line



FDC 71 VNP-W (3HP)



FDC 90 VNP-W (3,5HP)
FDC 100 VNP-W (4HP)



FDC 125 VNP-W (5HP)

MONOSPLIT SMART

CASSETTE 84X84

R32



FDT 71-100-125 VH
Standard white panel
T-PSA-5BW-E

FDT 71-100-125 VH
Anti-draft white panel
T-PSAE-5BW-E

FDT 71-100-125 VH
Standard black panel
T-PSA-5BB-E

FDT 71-100-125 VH
Black anti-draft panel
T-PSAE-5BB-E

Indoor unit model		FDT 71 VH		FDT 100 VH		FDT 100 VH		FDT 125 VH	
Outdoor unit model		FDC 71 VNP-W		FDC 90 VNP-W		FDC 100 VNP-W		FDC 125 VNP-W	
Type		DC-Inverter heat pump							
Nominal data									
Rated capacity (T=+35°C)	Cooling	kW	7.10 (1.50~7.30)	9.00 (2.10~9.50)	10.00 (2.10~10.20)	12.10 (5.00~12.10)			
Rated power input (T=+35°C)		kW	2.31	2.48	2.84	3.69			
Rated energy efficiency coefficient		EER ¹	3.07	3.63	3.52	3.28			
Rated capacity (T=+7°C)	Heating	kW	7.10 (1.10~7.30)	9.00 (1.70~9.50)	10.00 (1.70~10.40)	12.10 (4.00~13.30)			
Rated power input (T=+7°C)		kW	1.73	1.90	2.33	3.20			
Rated energy performance coefficient		COP ¹	4.10	4.74	4.29	3.78			
Seasonal data									
Design load (Pdesigngc)	Cooling	kW	7.10	9.00	10.00	12.10			
Seasonal energy efficiency index		SEER ²	6.34	7.10	7.08	6.30			
Seasonal energy efficiency class		626/2011 ³	A++	A++	A++	-			
Annual energy consumption		kWh/y	393	444	495	-			
Design load (Pdesigngh) @ -10°C	Heating (average climate conditions)	kW	5.70	6.00	6.40	12.10			
Seasonal energy efficiency index		SCOP ²	4.38	4.56	4.53	4.19			
Seasonal energy efficiency class		626/2011 ³	A+	A+	A+	-			
Annual energy consumption		kWh/y	1822	1842	1977	-			
Electrical data									
Power supply	Outdoor unit	Ph-V-Hz	1-220~240V-50Hz						
Power cable		Type	3 x 4 mm ²	3 x 4 mm ²	3 x 4 mm ²	3 x 4 mm ²			
Connection wires between I.U. and O.U.		nb.	4	4	4	4			
Nominal absorbed current	Cooling	A	10.20	11.00	12.10	15.50			
	Heating	A	7.80	8.40	9.90	13.50			
Maximum current		A	15.80	19.00	19.00	18.00			
Max power input		kW	3.58	4.46	4.46	4.75			
Refrigerant circuit data									
Refrigerant ⁴		Type (GWP)	R32 (675)						
Quantity of refrigerant pre-charge		Kg	1.3	1.7	1.7	2.25			
Tons of CO2 equivalent		t	0.878	1.148	1.148	1.519			
Diameter of refrigerant pipings liquid/gas		mm (inches)	ø6.35 (1/4") - ø12.7 (1/2")	ø6.35 (1/4") - ø15.88 (5/8")	ø6.35 (1/4") - ø15.88 (5/8")	ø9.52 (3/8") - ø15.88 (5/8")			
Max splitting distance		m	30	30	30	30			
Splitting level difference I.U./O.U.		m	20	20	20	20			
Splitting distance without additional charge		m	15	15	15	15			
Additional charge		g/m	20	20	20	54			
Indoor unit specifications									
Dimensions	LxDxH	mm	840x840x236	840x840x298	840x840x298	840x840x298			
Net weight		Kg	21	25	25	25			
Sound power level	Max	dB(A)	60	62	62	64			
Sound pressure level	P-Hi/Hi/Me/Lo	dB(A)	46/34/31/26	47/39/36/30	47/39/36/30	48/41/39/31			
Volume of air treated	P-Hi/Hi/Me/Lo	m ³ /h	1680/1080/900/720	2220/1560/1380/1020	2220/1560/1380/1020	2280/1680/1500/1080			
Outdoor unit specifications									
Dimensions	LxDxH	mm	800(+71)x290x640	800(+71)x340x750	880(+88)x340x750	970x370x845			
Net weight		Kg	45	57	57	73			
Sound power level	Max	dB(A)	67	67	68	73			
Sound pressure level	Max	dB(A)	54	55	56	57			
Volume of air treated	Max	m ³ /h	2520	3540	3780	4740			
Operating range (outdoor temperature)	Cooling	°C					-15~+46		
	Heating	°C					-15~+20		
Accessories									
Decorative panel				T-PSA-5BW-E (white) / T-PSA-5BB-E (black)					
Panel size	LxDxH	mm	950x950x35	950x950x35	950x950x35	950x950x35			
Net weight		Kg	5	5	5	5			
Wired control	RC-ES (LCD) / RC-EX3A (touch) / RCH-E3 (simplified)								
IR remote control (corner KIT)	RCN-T-5BW-E2 (white) / RCN-T-5BB-E2 (black)								
Optional parts									
Wi-Fi module	INWFIMHI001R100								
Human sensor (corner KIT)	LB-T-5BW-E (white) / LB-T-5BB-E (black)								
SUPERLINK II interface	SC-ADNA-E								
Anti-draft panel	T-PSAE-5BW-E (white) / T-PSAE-5BB-E (black)								

1. Value measured according to the harmonised standard EN 14511. 2. EU Regulation No. 206/2012 -- Value measured according to the harmonised standard EN 14825. 3. Delegated Regulation (EU) No 626/2011 regarding the new energy labelling of air conditioners. 4. Refrigerant leakage contributes to climate change. When released into the atmosphere, refrigerants with a lower global warming potential (GWP) contribute less to global warming than those with a higher GWP. This appliance contains a refrigerant with a GWP of 675. If 1 kg of this refrigerant fluid were released into the atmosphere, therefore, the impact on global warming would be 675 times higher than 1 kg of CO₂ over a period of 100 years. Under no circumstances should the user try to intervene on the refrigerant circuit or disassemble the product. Always contact qualified personnel if necessary.

MONOSPLIT SMART

DUCTED MEDIUM STATIC PRESSURE ADJUSTABLE



- **max 100**
Fan static pressure
- Unit with bottom or rear air intake
- **280 mm**
Height
- **30 m**
Splitting distance
- ESP function: automatic maintenance of the air flow rate as flow resistance varies
- Filter not included
- Compatible with **AIRZONE** systems

FDUM 71-100-125 VH

Indoor unit model			FDUM 71 VH	FDUM 100 VH	FDUM 100 VH	FDUM 125 VH
Outdoor unit model			FDC 71 VNP-W	FDC 90 VNP-W	FDC 100 VNP-W	FDC 125 VNP-W
Type		DC-Inverter heat pump				
Nominal data						
Rated capacity (T=+35°C)	Cooling	kW	7.10 (1.50~7.30)	9.00 (2.10~9.50)	10.00 (2.10~10.20)	12.10 (5.00~12.10)
Rated power input (T=+35°C)		kW	2.60	2.62	3.08	3.85
Rated energy efficiency coefficient		EER ¹	2.73	3.44	3.25	3.14
Rated capacity (T=+7°C)	Heating	kW	7.10 (1.10~7.30)	9.00 (1.70~9.50)	10.00 (1.70~10.40)	12.10 (4.00~13.30)
Rated power input (T=+7°C)		kW	1.89	1.98	2.45	3.28
Rated energy performance coefficient		COP ¹	3.76	4.55	4.08	3.69
Seasonal data						
Design load (Pdesignc)	Cooling	kW	7.10	9.00	10.00	12.10
Seasonal energy efficiency index		SEER ²	5.86	6.65	6.11	5.42
Seasonal energy efficiency class		626/2011 ³	A+	A++	A++	-
Annual energy consumption		kWh/y	425	474	573	-
Design load (Pdesignh) @ -10°C	Heating (average climate conditions)	kW	5.70	6.00	6.40	12.10
Seasonal energy efficiency index		SCOP ²	4.12	4.22	4.13	3.94
Seasonal energy efficiency class		626/2011 ³	A+	A+	A+	-
Annual energy consumption		kWh/y	1937	1990	2169	-
Electrical data						
Power supply	Outdoor unit	Ph-V-Hz	1-220~240V-50Hz			
Power cable		Type	3 x 4 mm ²	3 x 4 mm ²	3 x 4 mm ²	3 x 4 mm ²
Connection wires between I.U. and O.U.		nb.	4	4	4	4
Nominal absorbed current	Cooling	A	11.50	11.60	13.10	16.20
	Heating	A	8.50	8.80	10.40	13.80
Maximum current		A	15.80	19.00	19.00	20.00
Max power input		kW	3.58	4.46	4.46	4.75
Refrigerant circuit data						
Refrigerant ⁴		Type (GWP)	R32 (675)			
Quantity of refrigerant pre-charge		Kg	1.3	1.7	1.7	2.25
Tons of CO2 equivalent		t	0.878	1.148	1.148	1.519
Diameter of refrigerant pipings liquid/gas		mm (inches)	ø6.35 (1/4") - ø12.7 (1/2")	ø6.35 (1/4") - ø15.88 (5/8")	ø6.35 (1/4") - ø15.88 (5/8")	ø9.52 (3/8") - ø15.88 (5/8")
Max splitting distance		m	30	30	30	30
Splitting level difference I.U./O.U.		m	20	20	20	20
Splitting distance without additional charge		m	15	15	15	15
Additional charge		g/m	20	20	20	54
Indoor unit specifications						
Dimensions	LxDxH	mm	950x635x280	1370x740x280	1370x740x280	1370x740x280
Net weight		Kg	34	54	54	54
Sound power level	Max	dB(A)	65	65	65	67
Sound pressure level	P-Hi/Hi/Me/Lo	dB(A)	38/33/29/25	44/38/36/30	44/38/36/30	45/40/34/29
Volume of air treated	P-Hi/Hi/Me/Lo	m ³ /h	1440/1140/900/600	2160/1680/1500/1140	2160/1680/1500/1140	2340/1920/1560/1200
Fan static pressure	Std/Max	Pa	35/100	60/100	60/100	60/100
Outdoor unit specifications						
Dimensions	LxDxH	mm	800(+71)x290x640	800(+71)x340x750	880(+88)x340x750	970x370x845
Net weight		Kg	45	57	57	73
Sound power level	Max	dB(A)	67	67	68	73
Sound pressure level	Max	dB(A)	54	55	56	57
Volume of air treated	Max	m ³ /h	42	59	63	4740
Operating range (outdoor temperature)	Cooling	°C	-15~+46			
	Heating	°C	-15~+20			
Accessories						
Wired control			RC-E5 (LCD) / RC-EX3A (touch) / RC-EXZ3A (touch + zone control) / RCH-E3 (simplified)			
IR remote control (KIT)			RCN-KIT4-E2			
Optional parts						
Wi-Fi module			INWFIMH001R100			
Human sensor (KIT)			LB-KIT2			
SUPERLINK II interface			SC-ADNA-E			
Recovery filter (KIT)			UM-FL2EF			UM-FL3EF

1. Value measured according to the harmonised standard EN 14511. 2. EU Regulation No. 206/2012 -- Value measured according to the harmonised standard EN 14825. 3. Delegated Regulation (EU) No 626/2011 regarding the new energy labelling of air conditioners. 4. Refrigerant leakage contributes to climate change. When released into the atmosphere, refrigerants with a lower global warming potential (GWP) contribute less to global warming than those with a higher GWP. This appliance contains a refrigerant with a GWP of 675. If 1 kg of this refrigerant fluid were released into the atmosphere, therefore, the impact on global warming would be 675 times higher than 1 kg of CO₂ over a period of 100 years. Under no circumstances should the user try to intervene on the refrigerant circuit or disassemble the product. Always contact qualified personnel if necessary.

MONOSPLIT SMART

DUCTED HIGH STATIC PRESSURE ADJUSTABLE



- **max 200**
Fan static pressure
- Unit with bottom or rear air intake
- **280 mm**
Height
- **30 m**
Splitting distance
- ESP function: automatic maintenance of the air flow rate as flow resistance varies
- Filter not included
- Compatible with **AIRZONE** systems

FDU 71-100-125 VH

Indoor unit model	FDU 71 VH		FDU 100 VH		FDU 100 VH		FDU 125 VH	
Outdoor unit model	FDC 71 VNP-W		FDC 90 VNP-W		FDC 100 VNP-W		FDC 125 VNP-W	
Type	DC-Inverter heat pump							
Nominal data								
Rated capacity (T=+35°C)	Cooling	kW	7.10 (1.50~7.30)	9.00 (2.10~9.50)	10.00 (2.10~10.20)	12.10 (5.00~12.10)		
Rated power input (T=+35°C)		kW	2.60	2.62	3.08	3.85		
Rated energy efficiency coefficient		EER ¹	2.73	3.44	3.25	3.14		
Rated capacity (T=+7°C)	Heating	kW	7.10 (1.10~7.30)	9.00 (1.70~9.50)	10.00 (1.70~10.40)	12.10 (4.00~13.30)		
Rated power input (T=+7°C)		kW	1.89	1.98	2.45	3.28		
Rated energy performance coefficient		COP ¹	3.76	4.55	4.08	3.69		
Seasonal data								
Design load (Pdesignc)	Cooling	kW	7.10	9.00	10.00	12.10		
Seasonal energy efficiency index		SEER ²	5.86	6.66	6.11	5.42		
Seasonal energy efficiency class		626/2011 ³	A+	A++	A++	-		
Annual energy consumption		kWh/y	425	474	573	-		
Design load (Pdesignh) @ -10°C	Heating (average climate conditions)	kW	5.70	6.00	6.40	12.10		
Seasonal energy efficiency index		SCOP ²	4.12	4.22	4.13	3.94		
Seasonal energy efficiency class		626/2011 ³	A+	A+	A+	-		
Annual energy consumption		kWh/y	1937	1990	2169	-		
Electrical data								
Power supply	Outdoor unit	Ph-V-Hz	1-220~240V-50Hz					
Power cable		Type	3 x 4 mm ²	3 x 4 mm ²	3 x 4 mm ²	3 x 4 mm ²		
Connection wires between I.U. and O.U.		nb.	4	4	4	4		
Nominal absorbed current	Cooling	A	11.50	11.60	13.10	16.20		
	Heating	A	8.50	8.80	10.40	13.80		
Maximum current		A	15.80	19.00	19.00	20.00		
Max power input		kW	3.58	4.46	4.46	4.75		
Refrigerant circuit data								
Refrigerant ⁴		Type (GWP)	R32 (675)					
Quantity of refrigerant pre-charge		Kg	1.3	1.7	1.7	2.25		
Tons of CO2 equivalent		t	0.878	1.148	1.148	1.519		
Diameter of refrigerant pipings liquid/gas		mm (inches)	ø6.35 (1/4") - ø12.7 (1/2")	ø6.35 (1/4") - ø15.88 (5/8")	ø6.35 (1/4") - ø15.88 (5/8")	ø9.52 (3/8") - ø15.88 (5/8")		
Max splitting distance		m	30	30	30	30		
Splitting level difference I.U./O.U.		m	20	20	20	20		
Splitting distance without additional charge		m	15	15	15	15		
Additional charge		g/m	20	20	20	54		
Indoor unit specifications								
Dimensions	LxDxH	mm	950x635x280	1370x740x280	1370x740x280	1370x740x280		
Net weight		Kg	34	54	54	54		
Sound power level	Max	dB(A)	65	65	65	67		
Sound pressure level	P-Hi/Hi/Me/Lo	dB(A)	38/33/29/25	44/38/36/30	44/38/36/30	45/40/34/29		
Volume of air treated	P-Hi/Hi/Me/Lo	m ³ /h	1440/1140/900/600	2160/1680/1500/1140	2160/1680/1500/1140	2340/1920/1560/1200		
Fan static pressure	Std/Max	Pa	35/200	60/200	60/200	60/200		
Outdoor unit specifications								
Dimensions	LxDxH	mm	800(+71)x290x640	800(+71)x340x750	880(+88)x340x750	970x370x845		
Net weight		Kg	45	57	57	73		
Sound power level	Max	dB(A)	67	67	68	73		
Sound pressure level	Max	dB(A)	54	55	56	57		
Volume of air treated	Max	m ³ /h	2520	3540	3780	4740		
Operating range (outdoor temperature)	Cooling	°C	-15~+46					
	Heating	°C	-15~+20					
Accessories								
Wired control	RC-E5 (LCD) / RC-EX3A (touch) / RC-EXZ3A (touch + zone control) / RCH-E3 (simplified)							
IR remote control (KIT)	RCN-KIT4-E2							
Optional parts								
Wi-Fi module	INWFIMH1001R100							
Human sensor (KIT)	LB-KIT2							
SUPERLINK II interface	SC-ADNA-E							

1. Value measured according to the harmonised standard EN 14511. 2. EU Regulation No. 206/2012 -- Value measured according to the harmonised standard EN 14825. 3. Delegated Regulation (EU) No 626/2011 regarding the new energy labelling of air conditioners. 4. Refrigerant leakage contributes to climate change. When released into the atmosphere, refrigerants with a lower global warming potential (GWP) contribute less to global warming than those with a higher GWP. This appliance contains a refrigerant with a GWP of 675. If 1 kg of this refrigerant fluid were released into the atmosphere, therefore, the impact on global warming would be 675 times higher than 1 kg of CO₂, over a period of 100 years. Under no circumstances should the user try to intervene on the refrigerant circuit or disassemble the product. Always contact qualified personnel if necessary.

MONOSPLIT SMART

CEILING



- Ideal for very large environments, thanks to the particularly wide air flow
- **30 m**
Splitting distance
- Versatile installation thanks to drain pipe and refrigerant flexibility
- Polypropylene filter included

FDE 71-100-125 VH

FLEXIBLE PIPE ORIENTATION

Maximum flexibility: the refrigerant piping can be attached in 3 different positions (rear, top, right), as can that of the condensate drain (left, right).

Indoor unit model			FDE 71 VH	FDE 100 VH	FDE 100 VH	FDE 125 VH
Outdoor unit model			FDC 71 VNP-W	FDC 90 VNP-W	FDC 100 VNP-W	FDC 125 VNP-W
Type			DC-Inverter heat pump			
Nominal data						
Rated capacity (T=+35°C)	Cooling	kW	7.10 (1.50~7.30)	9.00 (2.10~9.50)	10.00 (2.10~10.20)	12.10 (5.00~12.10)
		kW	2.41	2.38	3.00	3.88
		EER ¹	2.95	3.78	3.33	3.12
Rated capacity (T=+7°C)	Heating	kW	7.10 (1.10~7.30)	9.00 (1.70~9.50)	10.00 (1.70~10.40)	12.10 (4.00~13.30)
		kW	1.96	1.99	2.36	3.30
		COP ¹	3.62	4.52	4.24	3.30
Seasonal data						
Design load (Pdesignc)	Cooling	kW	7.10	9.00	10.00	12.10
		SEER ²	6.44	6.78	6.63	5.88
		626/2011 ³	A++	A++	A++	-
Annual energy consumption	Heating (average climate conditions)	kWh/y	386	465	529	-
		kW	5.70	5.80	6.00	12.10
		SCOP ²	4.32	4.46	4.24	4.13
Seasonal energy efficiency class	Heating (average climate conditions)	626/2011 ³	A+	A+	A+	-
		kWh/y	1849	1920	1984	-
Electrical data						
Power supply	Outdoor unit	Ph-V-Hz	1-220~240V-50Hz			
Power cable		Type	3 x 4 mm ²	3 x 4 mm ²	3 x 4 mm ²	3 x 4 mm ²
Connection wires between I.U. and O.U.		nb.	4	4	4	4
Nominal absorbed current	Cooling	A	10.90	10.60	12.80	16.30
	Heating	A	8.80	8.80	10.10	13.90
Maximum current		A	15.80	19.00	19.00	18.00
Max power input		kW	3.58	4.46	4.46	4.75
Refrigerant circuit data						
Refrigerant ⁴		Type (GWP)	R32 (675)			
Quantity of refrigerant pre-charge		Kg	1.3	1.7	1.7	2.25
Tons of CO ₂ equivalent		t	0.878	1.148	1.148	1.519
Diameter of refrigerant pipings liquid/gas		mm (inches)	ø6.35 (1/4") - ø12.7 (1/2")	ø6.35 (1/4") - ø15.88 (5/8")	ø6.35 (1/4") - ø15.88 (5/8")	ø9.52 (3/8") - ø15.88 (5/8")
Max splitting distance		m	30	30	30	30
Splitting level difference I.U./O.U.		m	20	20	20	20
Splitting distance without additional charge		m	15	15	15	15
Additional charge		g/m	20	20	20	54
Indoor unit specifications						
Dimensions	LxDxH	mm	1320x690x210	1620x690x250	1620x690x250	1620x690x250
Net weight		Kg	33	43	43	43
Sound power level	Max	dB(A)	60	64	64	64
Sound pressure level	P-Hi/Hi/Me/Lo	dB(A)	47/41/37/32	48/43/38/34	48/43/38/34	48/45/40/35
Volume of air treated	P-Hi/Hi/Me/Lo	m ³ /h	1200/960/780/600	1920/1560/1260/990	1920/1560/1260/990	1920/1740/1380/1020
Outdoor unit specifications						
Dimensions	LxDxH	mm	800(+71)x290x640	800(+71)x340x750	880(+88)x340x750	970x370x845
Net weight		Kg	45	57	57	73
Sound power level	Max	dB(A)	67	67	68	73
Sound pressure level	Max	dB(A)	54	55	56	57
Volume of air treated	Max	m ³ /h	2520	3540	3780	4740
Operating range (outdoor temperature)	Cooling	°C	-15~+46			
	Heating	°C	-15~+20			
Accessories						
Wired control	RC-E5 (LCD) / RC-EX3A (touch) / RCH-E3 (simplified)					
IR remote control (KIT)	RCN-E-E3					
Optional parts						
Wi-Fi module	INWFIMH1001R100					
Human sensor (KIT)	LB-E					
SUPERLINK II interface	SC-ADNA-E					

1. Value measured according to the harmonised standard EN 14511. 2. EU Regulation No. 206/2012 -- Value measured according to the harmonised standard EN 14825. 3. Delegated Regulation (EU) No 626/2011 regarding the new energy labelling of air conditioners. 4. Refrigerant leakage contributes to climate change. When released into the atmosphere, refrigerants with a lower global warming potential (GWP) contribute less to global warming than those with a higher GWP. This appliance contains a refrigerant with a GWP of 675. If 1 kg of this refrigerant fluid were released into the atmosphere, therefore, the impact on global warming would be 675 times higher than 1 kg of CO₂, over a period of 100 years. Under no circumstances should the user try to intervene on the refrigerant circuit or disassemble the product. Always contact qualified personnel if necessary.

MONOSPLIT SMART

COLUMN



FDF 71-100 VH

- Ideal for restaurants, shops and offices applications, without false ceiling or high ceilings
- **25 m** Splitting distance
- Wide and powerful air flow
- Easy transport and installation
- The wired control has a alarm function in case of gas leakage. The gas sensor is on the base of the unit

Indoor unit model		FDF 71 VH		FDF 100 VH		FDF 100 VH	
Outdoor unit model		FDC 71 VNP-W		FDC 90 VNP-W		FDC 100 VNP-W	
Type		DC-Inverter heat pump					
Control (included)		Wired control TOUCH with gas leak alarm					
Nominal data							
Rated capacity (T=+35°C)	Cooling	kW	7.10 (1.50~7.30)	9.00 (2.10~9.50)	10.00 (2.10~10.20)		
Rated power input (T=+35°C)		kW	2.51	2.5	3.39		
Rated energy efficiency coefficient		EER1	2.82	3.60	2.95		
Rated capacity (T=+7°C)	Heating	kW	7.10 (1.10~7.30)	9.00 (1.70~9.50)	10.00 (1.70~10.40)		
Rated power input (T=+7°C)		kW	2.02	2.24	2.71		
Rated energy performance coefficient		COP1	3.51	4.02	3.69		
Seasonal data							
Design load (Pdesignc)	Cooling	kW	7.10	9.00	10.00		
Seasonal energy efficiency index		SEER2	5.85	5.91	5.43		
Seasonal energy efficiency class		626/20113	A+	A+	A		
Annual energy consumption		kWh/y	425	535	645		
Design load (Pdesignh) @ -10°C	Heating (average climate conditions)	kW	5.70	6.00	6.40		
Seasonal energy efficiency index		SCOP2	3.91	4.24	3.94		
Seasonal energy efficiency class		626/20113	A	A+	A		
Annual energy consumption		kWh/y	2039	1981	2274		
Electrical data							
Power supply	Outdoor unit	Ph-V-Hz	1-220~240V-50Hz				
Power cable		Type	3 x 4 mm ²	3 x 4 mm ²	3 x 4 mm ²		
Connection wires between I.U. and O.U.		nb.	4	4	4		
Nominal absorbed current	Cooling	A	11.10	11.10	15.00		
	Heating	A	9.10	9.90	12.00		
Maximum current		A	15.80	19.00	19.00		
Max power input		kW	3.58	4.46	4.46		
Refrigerant circuit data							
Refrigerant ⁴	Type (GWP)	R32 (675)					
Quantity of refrigerant pre-charge	Kg	1.3	1.7	1.7			
Tons of CO2 equivalent	t	0.878	1.148	1.148			
Diameter of refrigerant pipings liquid/gas	mm (inches)	ø6.35(1/4") - ø12.7(1/2")	ø6.35 (1/4") - ø15.88 (5/8")	ø6.35 (1/4") - ø15.88 (5/8")	ø6.35 (1/4") - ø15.88 (5/8")		
Max splitting distance	m	26	25	25			
Splitting level difference I.U./O.U.	m	20	20	20			
Splitting distance without additional charge	m	11	10	10			
Additional charge	g/m	20	20	20			
Indoor unit specifications							
Dimensions	LxDxH	mm	600x329x1850	600x329x1850	600x329x1850		
Net weight		Kg	47	49	49		
Sound power level	Max	dB(A)	55	65	65		
Sound pressure level	P-Hi/Hi/Me/Lo	dB(A)	42/39/35/33	53/51/49/44	53/51/49/44		
Volume of air treated	P-Hi/Hi/Me/Lo	m ³ /h	1080/960/840/720	1620/1560/1380/1140	1620/1560/1380/1140		
Refrigerant gas leak detector			Included				
Outdoor unit specifications							
Dimensions	LxDxH	mm	800(+71)x290x640	800(+71)x340x750	880(+88)x340x750		
Net weight		Kg	45	57	57		
Sound power level	Max	dB(A)	67	67	68		
Sound pressure level	Max	dB(A)	54	55	56		
Volume of air treated	Max	m ³ /h	2520	3540	3780		
Operating range (outdoor temperature)	Cooling	°C	-15~+46				
	Heating	°C	-15~+20				
Optional parts							
Wi-Fi module			INWFMH1001R100				
Human sensor (KIT)			LB-KIT2				
SUPERLINK II interface			SC-ADNA-E				
IR remote control (KIT)			RCN-KIT4-E2				

1. Value measured according to the harmonised standard EN 14511. 2. EU Regulation No. 206/2012 -- Value measured according to the harmonised standard EN 14825. 3. Delegated Regulation (EU) No 626/2011 regarding the new energy labelling of air conditioners. 4. Refrigerant leakage contributes to climate change. When released into the atmosphere, refrigerants with a lower global warming potential (GWP) contribute less to global warming than those with a higher GWP. This appliance contains a refrigerant with a GWP of 675. If 1 kg of this refrigerant fluid were released into the atmosphere, therefore, the impact on global warming would be 675 times higher than 1 kg of CO₂, over a period of 100 years. Under no circumstances should the user try to intervene on the refrigerant circuit or disassemble the product. Always contact qualified personnel if necessary.

MONOSPLIT SMART

WALL



SRK 71-100 ZR-WF

- **339 mm**
Height
- **30 m**
Splitting distance
- **25 dB(A)**
Sound power level (7.10 kW),
maximum quiet
- Antibacterial treatment on fan
- The powerful air flow is realized with Jet technology
- Ideal for large living rooms and shops
- Equipped with dust and photocatalytic filters

Indoor unit model		SRK 71 ZR-WF		SRK 100 ZR-WF	
Outdoor unit model		FDC 71 VNP-W		FDC 100 VNP-W	
Type		DC-Inverter heat pump			
Control (included)		Remote control			
Nominal data					
Rated capacity (T=+35°C)	Cooling	kW	7.10 (1.50~7.30)	9.60 (2.10~9.60)	
Rated power input (T=+35°C)		kW	2.36	3.10	
Rated energy efficiency coefficient		EER1	3.01	3.10	
Rated capacity (T=+7°C)	Heating	kW	7.10 (1.10~7.30)	10.00 (1.70~10.40)	
Rated power input (T=+7°C)		kW	1.88	2.80	
Rated energy performance coefficient		COP1	3.78	3.57	
Seasonal data					
Design load (Pdesignc)	Cooling	kW	7.10	9.60	
Seasonal energy efficiency index		SEER2	6.75	6.11	
Seasonal energy efficiency class		626/20113	A++	A++	
Annual energy consumption		kWh/y	369	551	
Design load (Pdesignh) @ -10°C	Heating (average climate conditions)	kW	5.70	6.00	
Seasonal energy efficiency index		SCOP2	4.55	4.14	
Seasonal energy efficiency class		626/20113	A+	A+	
Annual energy consumption		kWh/y	1756	2028	
Electrical data					
Power supply	Outdoor unit	Ph-V-Hz	1-220~240V-50Hz		
Power cable		Type	3 x 4 mm ²	3 x 4 mm ²	
Connection wires between I.U. and O.U.		nb.	4	4	
Nominal absorbed current	Cooling	A	10.50	13.20	
	Heating	A	8.40	11.90	
Maximum current		A	15.80	19.00	
Max power input		kW	3.58	4.46	
Refrigerant circuit data					
Refrigerant ⁴	Type (GWP)	R32 (675)			
Quantity of refrigerant pre-charge	Kg	1.3	1.7		
Tons of CO2 equivalent	t	0.878	1.148		
Diameter of refrigerant pipings liquid/gas	mm (inches)	ø6.35(1/4") - ø12.7(1/2")	ø6.35 (1/4") - ø15.88 (5/8")		
Max splitting distance	m	30	30		
Splitting level difference I.U./O.U.	m	20	20		
Splitting distance without additional charge	m	15	15		
Additional charge	g/m	20	20		
Indoor unit specifications					
Dimensions	LxDxH	mm	1197x262x339	1197x262x339	
Net weight		Kg	15.5	16.5	
Sound power level	Max	dB(A)	60	63	
Sound pressure level (Hi/Mi/Lo/Ulo)	Cooling	dB(A)	44/41/37/25	48/45/40/27	
	Heating		46/39/35/28	48/43/38/30	
Volume of air treated (Hi/Mi/Lo/Ulo)	Cooling	m ³ /h	1230/1116/972/624	1470/1278/1056/624	
	Heating		1500/1188/1038/798	1650/1392/1146/816	
Outdoor unit specifications					
Dimensions	LxDxH	mm	800(+71)x290x640	880(+88)x340x750	
Net weight		Kg	45	57	
Sound power level	Max	dB(A)	67	68	
Sound pressure level	Max	dB(A)	54	56	
Volume of air treated	Max	m ³ /h	2520	3780	
Operating range (outdoor temperature)	Cooling	°C	-15~+46		
	Heating	°C	-15~+20		
Optional parts					
Wi-Fi module					Included
Interface for home automation connection and wired control ⁵					SC-BIKN2-E

1. Value measured according to the harmonised standard EN 14511. 2. EU Regulation No. 206/2012 - Value measured according to the harmonised standard EN 14825. 3. Delegated Regulation (EU) No 626/2011 regarding the new energy labelling of air conditioners. 4. Refrigerant leakage contributes to climate change. When released into the atmosphere, refrigerants with a lower global warming potential (GWP) contribute less to global warming than those with a higher GWP. This appliance contains a refrigerant with a GWP of 675. If 1 kg of this refrigerant fluid were released into the atmosphere, therefore, the impact on global warming would be 675 times higher than 1 kg of CO₂ over a period of 100 years. Under no circumstances should the user try to intervene on the refrigerant circuit or disassemble the product. Always contact qualified personnel if necessary. 5. Home automation and optional protocols with dedicated interfaces: KNX, Modbus, BACnet.



MULTISPLIT HYPER

TWIN / TRIPLE COMBINATIONS



Model	Indoor unit		FDT~VH	FDTC~VH	FDUM~VH	FDE~VH	FDF~VH	SRK~ZSX-WF	FDT~VH	FDTC~VH	FDUM~VH	FDE~VH	SRK~ZSX-WF	
	Combinations	TWIN	40+40	40+40	40+40	40+40								
Outdoor unit			FDC 71 VNX-W											
Rated capacity (T=35°C)	Cooling	kW	7.10	7.10	7.10	7.10								
Rated power input (T=35°C)		kW	1.61	1.73	1.76	1.76								
Rated energy efficiency coefficient		EER ¹	4.40	4.12	4.03	4.03								
Rated capacity (T=7°C)	Heating	kW	8.00	8.00	8.00	8.00								
Rated power input (T=7°C)		kW	1.83	1.83	1.80	2.10								
Rated energy efficiency coefficient		COP ¹	4.38	4.37	4.44	3.81								
Installation accessories	DIS-WA1G													
Controls	RC-EX3A / RC-E5													

Model	Indoor unit		FDT~VH	FDTC~VH	FDUM~VH	FDE~VH	FDF~VH	SRK~ZSX-WF	FDT~VH	FDTC~VH	FDUM~VH	FDE~VH	SRK~ZSX-WF	
	Combinations	TWIN	50+50	50+50	50+50	50+50								
Outdoor unit			FDC 100 VSX-W											
Rated capacity (T=35°C)	Cooling	kW	10.00	10.00	10.00	10.00		FDC 100 VSX-W						
Rated power input (T=35°C)		kW	2.30	2.60	2.66	2.48		10.00						
Rated energy efficiency coefficient		EER ¹	4.35	3.84	3.76	4.04		2.47						
Rated capacity (T=7°C)	Heating	kW	11.20	11.20	11.20	11.20		11.20						
Rated power input (T=7°C)		kW	2.64	3.04	2.96	2.88		2.60						
Rated energy efficiency coefficient		COP ¹	4.25	3.69	3.79	3.89		4.31						
Installation accessories	DIS-WA1G							DIS-WA1G						
Controls	RC-EX3A / RC-E5							RC-EX3A / RC-E5						
Communication interface	-							2 x SC-BIKN2-E						

Model	Indoor unit		FDT~VH	FDTC~VH	FDUM~VH	FDE~VH	FDF~VH	SRK~ZSX-WF	FDT~VH	FDTC~VH	FDUM~VH	FDE~VH	SRK~ZSX-WF	
	Combinations	TWIN	60+60	60+60	60+60	60+60								
Outdoor unit			FDC 125 VSX-W											
Rated capacity (T=35°C)	Cooling	kW	12.50	12.50	12.50	12.50		FDC 125 VSX-W						
Rated power input (T=35°C)		kW	2.98	3.67	3.26	3.49		12.50						
Rated energy efficiency coefficient		EER ¹	4.19	3.41	3.83	3.58		3.43						
Rated capacity (T=7°C)	Heating	kW	14.00	14.00	14.00	14.00		14.00						
Rated power input (T=7°C)		kW	3.03	4.05	3.26	3.27		3.42						
Rated energy efficiency coefficient		COP ¹	4.62	3.45	4.30	4.29		4.09						
Installation accessories	DIS-WA1G							DIS-WA1G						
Controls	RC-EX3A / RC-E5							RC-EX3A / RC-E5						
Communication interface	-							2 x SC-BIKN2-E						

Model	Indoor unit		FDT~VH	FDTC~VH	FDUM~VH	FDE~VH	FDF~VH	SRK~ZSX-WF	FDT~VH	FDTC~VH	FDUM~VH	FDE~VH	SRK~ZSX-WF	
	Combinations	TWIN	71+71		71+71	71+71								71+71
Outdoor unit			FDC 140 VSX-W											
Rated capacity (T=35°C)	Cooling	kW	14.00		14.00	14.00	14.00		50+50+50	50+50+50	50+50+50	50+50+50	50+50+50	
Rated power input (T=35°C)		kW	3.44		3.97	4.16	3.78		14.00	14.00	14.00	14.00	14.00	
Rated energy efficiency coefficient		EER ¹	4.07		3.53	3.36	3.71		3.48	3.96	4.03	3.72	4.03	
Rated capacity (T=7°C)	Heating	kW	16.00		16.00	16.00	16.00		4.02	3.54	3.48	3.76	3.48	
Rated power input (T=7°C)		kW	3.64		3.91	3.97	4.27		16.00	16.00	16.00	16.00	16.00	
Rated energy efficiency coefficient		COP ¹	4.40		4.10	4.03	3.75		3.74	4.34	4.04	4.11	4.04	
Installation accessories	DIS-WA1G							DIS-TA1G						
Controls	RC-EX3A / RC-E5							RC-EX3A / RC-E5						
Communication interface	-												3 x SC-BIKN2-E	

¹ Value measured according to harmonised standard EN14511.

BRANCH PIPE KIT

DIS-WA1G	DIS-WB1G	DIS-TA1G	DIS-TB1G
Gas side	Gas side	Gas side	Gas side
Liquid side	Liquid side	Liquid side	Liquid side
Reducer	Reducer	Reducer	

MULTISPLIT HYPER

V MULTI COMBINATIONS











R32



Model	Indoor unit	FDE~VH / FDT~VH		
	V-Multi combinations	40+40		
	Outdoor unit	FDC 71 VNX-W		
Rated capacity (T=35°C)		kW	7.10	
Rated power input (T=35°C)	Cooling	kW	1.63	
Rated energy efficiency coefficient		EER ¹	4.36	
Rated capacity (T=7°C)		kW	8.00	
Rated power input (T=7°C)	Heating	kW	1.85	
Rated energy efficiency coefficient		COP ¹	4.32	
Installation accessories	DIS-WA1G			
Controls	RC-EX3A / RC-E5			
Model	Indoor unit	FDE~VH / FDT~VH		
	V-Multi combinations	50+50		
	Outdoor unit	FDC 100 VSX-W		
Rated capacity (T=35°C)		kW	10.00	
Rated power input (T=35°C)	Cooling	kW	2.47	
Rated energy efficiency coefficient		EER ¹	4.05	
Rated capacity (T=7°C)		kW	11.20	
Rated power input (T=7°C)	Heating	kW	2.87	
Rated energy efficiency coefficient		COP ¹	3.90	
Installation accessories	DIS-WA1G			
Controls	RC-EX3A / RC-E5			
Model	Indoor unit	FDE~VH / FDT~VH		
	V-Multi combinations	60+60	50+71	
	Outdoor unit	FDC 125 VSX-W		
Rated capacity (T=35°C)		kW	12.50	12.50
Rated power input (T=35°C)	Cooling	kW	3.48	3.45
Rated energy efficiency coefficient		EER ¹	3.59	3.62
Rated capacity (T=7°C)		kW	14.00	14.00
Rated power input (T=7°C)	Heating	kW	3.26	3.24
Rated energy efficiency coefficient		COP ¹	4.29	4.32
Installation accessories	DIS-WA1G			
Controls	RC-EX3A / RC-E5			
Model	Indoor unit	FDE~VH / FDT~VH		
	V-Multi combinations	71+71		
	Outdoor unit	FDC 140 VSX-W		
Rated capacity (T=35°C)		kW	14.00	FDE~VH / FDT~VH 50+50+50 14.00
Rated power input (T=35°C)	Cooling	kW	4.16	4.13
Rated energy efficiency coefficient		EER ¹	3.37	3.39
Rated capacity (T=7°C)		kW	16.00	16.00
Rated power input (T=7°C)	Heating	kW	4.12	4.09
Rated energy efficiency coefficient		COP ¹	3.88	3.91
Installation accessories	DIS-WA1G			DIS-TA1G
Controls	RC-EX3A / RC-E5			RC-EX3A / RC-E5

¹ Value measured according to harmonised standard EN14511.

BRANCH PIPE KIT

DIS-WA1G	DIS-WB1G	DIS-TA1G	DIS-TB1G
Gas side 	Gas side 	Gas side 	Gas side 
Liquid side 	Liquid side 	Liquid side 	Liquid side 
Reducer 	Reducer 	Reducer 	

MULTISPLIT SUPER

TWIN / TRIPLE / DOUBLE TWIN COMBINATIONS

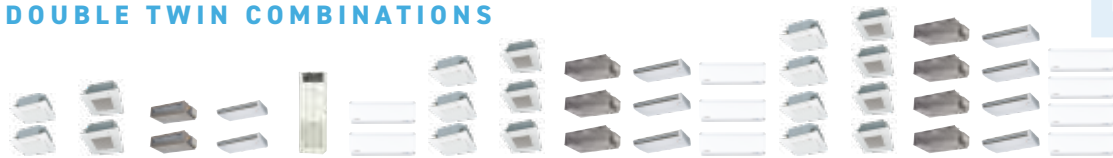

R32

Model	Indoor unit		FDT-VH	FDTC-VH	FDUM-VH	FDE-VH	FDV-VH	SRK-ZSX-WF	FDT-VH	FDTC-VH	FDUM-VH	FDE-VH	SRK-ZSX-W	FDT-VH	FDTC-VH	FDUM-VH	FDE-VH	SRK-ZSX-W
	Combinations	TWIN	50+50	50+50	50+50	50+50	50+50	50+50										
Outdoor unit		FDC100 VNS/A-W																
Rated capacity (T=35°C)	Cooling	KW	10.00	10.00	10.00	10.00		10.00										
Rated power input (T=35°C)		KW	2.82	3.15	3.25	3.12		2.89										
Rated energy efficiency coefficient		EER ¹	3.55	3.17	3.08	3.21		3.46										
Rated capacity (T=7°C)	Heating	KW	11.20	11.20	11.20	11.20		11.20										
Rated power input (T=7°C)		KW	2.73	3.05	3.04	2.99		2.61										
Rated energy efficiency coefficient		COP ¹	4.11	3.67	3.68	3.75		4.29										
Installation accessories	DIS-WA1G																	
Controls	RC-E33A/RC-E5																	
Communication interface	2xSC-BKN2-E																	

Model	Indoor unit		FDT-VH	FDTC-VH	FDUM-VH	FDE-VH	FDV-VH	SRK-ZSX-WF	FDT-VH	FDTC-VH	FDUM-VH	FDE-VH	SRK-ZSX-WF	FDT-VH	FDTC-VH	FDUM-VH	FDE-VH	SRK-ZSX-WF
	Combinations	TWIN	60+60	60+60	60+60	60+60	60+60	60+60										
Outdoor unit		FDC125 VNS/A-W																
Rated capacity (T=35°C)	Cooling	KW	12.50	12.50	12.50	12.50		12.50										
Rated power input (T=35°C)		KW	3.79	4.90	4.53	4.16		4.54										
Rated energy efficiency coefficient		EER ¹	3.30	2.55	2.76	3.00		2.76										
Rated capacity (T=7°C)	Heating	KW	14.00	14.00	14.00	14.00		14.00										
Rated power input (T=7°C)		KW	3.31	4.30	3.52	3.54		3.58										
Rated energy efficiency coefficient		COP ¹	4.23	3.26	3.98	3.95		3.91										
Installation accessories	DIS-WA1G																	
Controls	RC-E33A/RC-E5																	
Communication interface	2xSC-BKN2-E																	

Model	Indoor unit		FDT-VH	FDTC-VH	FDUM-VH	FDE-VH	FDV-VH	SRK-ZR-WF	FDT-VH	FDTC-VH	FDUM-VH	FDE-VH	SRK-ZR-WF	FDT-VH	FDTC-VH	FDUM-VH	FDE-VH	SRK-ZR-WF
	Combinations	TWIN TRIPLE	71+71		71+71	71+71	71+71	71+71										
Outdoor unit		FDC140 VNS/A-W																
Rated capacity (T=35°C)	Cooling	KW	13.60		13.60	13.60	13.60	13.60	13.60	13.60	13.60	13.60	13.60	13.60				
Rated power input (T=35°C)		KW	4.22		5.02	4.74	4.46	4.26	4.22	4.75	5.02	4.74	4.26	4.26				
Rated energy efficiency coefficient		EER ¹	3.22		2.71	2.87	3.05	3.19	3.22	2.86	2.71	2.87	3.19	3.19				
Rated capacity (T=7°C)	Heating	KW	15.50		15.50	16.00	15.50	16.00	15.50	15.50	15.50	15.50	15.50	15.50				
Rated power input (T=7°C)		KW	3.57		4.20	4.21	4.49	4.03	3.57	4.60	4.20	4.21	3.74	3.74				
Rated energy efficiency coefficient		COP ¹	4.34		3.69	3.68	3.46	3.85	3.88	3.37	3.69	3.68	4.14	4.14				
Installation accessories	DIS-WA1G																	
Controls	RC-E33A/RC-E5																	
Communication interface	2xSC-BKN2-E																	

Model	Indoor unit		FDT-VH	FDTC-VH	FDUM-VH	FDE-VH	FDV-VH	SRK-ZR-WF	FDT-VH	FDTC-VH	FDUM-VH	FDE-VH	SRK-ZR-WF	FDT-VH	FDTC-VH	FDUM-VH	FDE-VH	SRK-ZR-WF
	Combinations	TWIN TRIPLE D. TWIN	100+100		100+100	100+100	100+100	100+100	71+71+71		71+71+71	71+71+71						
Outdoor unit		FDC200 VSA-W																
Rated capacity (T=35°C)	Cooling	KW	20.00		20.00	20.00	20.00	20.00	20.00	20.00	20.00	20.00	20.00	20.00				
Rated power input (T=35°C)		KW	5.48		6.58	6.29	6.71	7.46	5.56	6.58	6.29	5.78	6.92	6.29				
Rated energy efficiency coefficient		EER ¹	3.65		3.04	3.18	2.98	2.68	3.60	3.04	3.18	3.46	2.89	3.18				
Rated capacity (T=7°C)	Heating	KW	22.40		22.40	22.40	22.40	22.40	22.40	22.40	22.40	22.40	22.40	22.40				
Rated power input (T=7°C)		KW	5.27		5.59	5.66	6.06	6.87	5.27	5.59	5.66	5.8	6.36	5.66				
Rated energy efficiency coefficient		COP ¹	4.25		4.01	3.96	3.69	3.26	4.25	4.01	3.96	3.86	3.52	3.96				
Installation accessories	DIS-WB1G																	
Controls	RC-E33A/RC-E5																	
Communication interface	2xSC-BKN2-E																	

Model	Indoor unit		FDT-VH	FDTC-VH	FDUM-VH	FDE-VH	FDV-VH	SRK-ZR-WF	FDT-VH	FDTC-VH	FDUM-VH	FDE-VH	SRK-ZR-WF	FDT-VH	FDTC-VH	FDUM-VH	FDE-VH	SRK-ZR-WF
	Combinations	TWIN TRIPLE D. TWIN	125+125		125+125	125+125	125+125	125+125										
Outdoor unit		FDC250 VSA-W																
Rated capacity (T=35°C)	Cooling	KW	25.00		25.00	25.00	25.00	25.00	25.00	25.00	25.00	25.00	25.00	25.00				
Rated power input (T=35°C)		KW	8.20		8.74	8.20	9.54		8.74	8.20	9.54	7.30	9.43	8.04				
Rated energy efficiency coefficient		EER ¹	3.05		2.86	3.05	2.62		2.86	3.05	2.62	3.42	2.65	3.11				
Rated capacity (T=7°C)	Heating	KW	28.00		28.00	28.00	28.00	28.00	28.00	28.00	28.00	28.00	28.00	28.00				
Rated power input (T=7°C)		KW	7.37		7.90	7.93	8.37		7.90	7.93	8.37	6.80	8.75	7.32				
Rated energy efficiency coefficient		COP ¹	3.80		3.54	3.53	3.35		3.54	3.53	3.35	4.12	3.20	3.83				
Installation accessories	DIS-WB1G																	
Controls	RC-E33A/RC-E5																	
Communication interface	2xSC-BKN2-E																	

Model	Indoor unit		FDT-VH	FDTC-VH	FDUM-VH	FDE-VH	FDV-VH	SRK-ZR-WF	FDT-VH	FDTC-VH	FDUM-VH	FDE-VH	SRK-ZR-WF	FDT-VH	FDTC-VH	FDUM-VH	FDE-VH	SRK-ZR-WF
	Combinations	TWIN TRIPLE D. TWIN	140+140		140+140	140+140	140+140	140+140										
Outdoor unit		FDC280 VSA-W																
Rated capacity (T=35°C)	Cooling	KW	27.00		27.00	27.00	27.00	27.00	27.00	27.00	27.00	27.00	27.00	27.00				
Rated power input (T=35°C)		KW	9.11		10.05	9.31	10.93		10.05	9.31	10.93	7.77	9.15	9.15				
Rated energy efficiency coefficient		EER ¹	2.96		2.69	2.90	2.47		2.69	2.90	2.47	3.47	2.95	2.95				
Rated capacity (T=7°C)	Heating	KW	30.00		30.00	30.00	30.00	30.00	30.00	30.00	30.00	30.00	30.00	30.00				
Rated power input (T=7°C)		KW	8.95		8.47	8.98	9.47		8.47	8.98	9.47	8.60	8.98	8.98				
Rated energy efficiency coefficient		COP ¹	3.35		3.54	3.34	3.17		3.54	3.34	3.17	3.49	3.34	3.34				
Installation accessories	DIS-WB1G																	
Controls	RC-E33A/RC-E5																	
Communication interface	2xSC-BKN2-E																	

¹ Value measured according to harmonised standard EN14511.

MULTISPLIT SUPER

V MULTI COMBINATIONS

R32



Model	Indoor unit		FDE~VH / FDT~VH				
	Combinations	V-Multi	50+50				
	Outdoor unit		FDC 100 VN(S)A-W				
Rated capacity (T=35°C)	Cooling	kW	10.00				
Rated power input (T=35°C)		kW	3.11				
Rated energy efficiency coefficient		EER ¹	3.22				
Rated capacity (T=7°C)	Heating	kW	11.20				
Rated power input (T=7°C)		kW	2.98				
Rated energy efficiency coefficient		COP ¹	3.76				
Installation accessories			DIS-WA1G				
Controls			RC-EX3A / RC-E5				

Model	Indoor unit		FDE~VH / FDT~VH				
	Combinations	V-Multi	60+60	50+71			
	Outdoor unit		FDC 125 VN(S)A-W				
Rated capacity (T=35°C)	Cooling	kW	12.50	12.50			
Rated power input (T=35°C)		kW	4.15	4.13			
Rated energy efficiency coefficient		EER ¹	3.01	3.02			
Rated capacity (T=7°C)	Heating	kW	14.00	14.00			
Rated power input (T=7°C)		kW	3.53	3.51			
Rated energy efficiency coefficient		COP ¹	3.97	3.99			
Installation accessories			DIS-WA1G				
Controls			RC-EX3A / RC-E5				

Model	Indoor unit		FDE~VH / FDT~VH		FDE~VH / FDT~VH		
	Combinations	V-Multi	71+71		50+50+50		
	Outdoor unit		FDC 140 VN(S)A-W		FDC 140 VN(S)A-W		
Rated capacity (T=35°C)	Cooling	kW	13.60		13.60		
Rated power input (T=35°C)		kW	4.75		4.73		
Rated energy efficiency coefficient		EER ¹	2.86		2.88		
Rated capacity (T=7°C)	Heating	kW	15.50		15.50		
Rated power input (T=7°C)		kW	4.22		4.20		
Rated energy efficiency coefficient		COP ¹	3.67		3.69		
Installation accessories			DIS-WA1G		DIS-TA1G		
Controls			RC-EX3A / RC-E5		RC-EX3A / RC-E5		

Model	Indoor unit		FDE~VH / FDT~VH					FDE~VH / FDT~VH
	Combinations	V-Multi	100+100	71+125	71+71+71			
	Outdoor unit		FDC 200 VSA-W					
Rated capacity (T=35°C)	Cooling	kW	20.00	20.00	20.00			50+50+50+50
Rated power input (T=35°C)		kW	5.48	5.44	5.46			FDC 200 VSA-W
Rated energy efficiency coefficient		EER ¹	3.65	3.68	3.66			20.00
Rated capacity (T=7°C)	Heating	kW	22.40	22.40	22.40			5.38
Rated power input (T=7°C)		kW	5.27	5.23	5.25			3.72
Rated energy efficiency coefficient		COP ¹	4.25	4.28	4.27			22.40
Installation accessories			DIS-WB1G		DIS-TB1G			5.17
Controls			RC-EX3A / RC-E5					4.33
								2xDIS-WA1G + 1xDIS-WB1G
								RC-EX3A / RC-E5

Model	Indoor unit		FDE~VH / FDT~VH		FDE~VH / FDT~VH			
	Combinations	V-Multi	125+125		60+60+125	71+71+100	60+60+60+60	
	Outdoor unit		FDC 250 VSA-W		FDC 250 VSA-W			
Rated capacity (T=35°C)	Cooling	kW	25.00		25.00	25.00	25.00	
Rated power input (T=35°C)		kW	8.20		8.20	8.21	8.20	
Rated energy efficiency coefficient		EER ¹	3.05		3.05	3.05	3.05	
Rated capacity (T=7°C)	Heating	kW	28.00		28.00	28.00	28.00	
Rated power input (T=7°C)		kW	7.37		7.37	7.38	7.37	
Rated energy efficiency coefficient		COP ¹	3.80		3.80	3.79	3.80	
Installation accessories			DIS-WB1G		DIS-TB1G		2xDIS-WA1G + 1xDIS-WB1G	
Controls			RC-EX3A / RC-E5		RC-EX3A / RC-E5			

Model	Indoor unit		FDE~VH / FDT~VH		FDE~VH / FDT~VH		
	Combinations	V-Multi	140+140		71+71+140		
	Outdoor unit		FDC 280 VSA-W		FDC 280 VSA-W		
Rated capacity (T=35°C)	Cooling	kW	27.00		27.00		
Rated power input (T=35°C)		kW	9.11		9.13		
Rated energy efficiency coefficient		EER ¹	2.96		2.96		
Rated capacity (T=7°C)	Heating	kW	30.00		30.00		
Rated power input (T=7°C)		kW	8.95		8.97		
Rated energy efficiency coefficient		COP ¹	3.35		3.34		
Installation accessories			DIS-WB1G		DIS-TB1G		2xDIS-WA1G + 1xDIS-WB1G
Controls			RC-EX3A / RC-E5		RC-EX3A / RC-E5		RC-EX3A / RC-E5

¹Value measured according to harmonised standard EN14511.

BRANCH PIPE KIT

DIS-WA1G	DIS-WB1G	DIS-TA1G	DIS-TB1G
----------	----------	----------	----------

ENTHALPY HEAT RECOVERY UNIT

SAF 150-1000E7

During winter, these recover some of the energy contained in the renewal air expelled from the rooms that would otherwise be dispersed into the atmosphere, using it to preheat the air coming in from outside.

During summer, the exchange is more effective in warmer climates, where the cool air expelled is used to pre-cool the air coming in from outside.

The recovery of dispersed energy reduces the heating requirements of the spaces in a building, ensuring lower emissions and considerable long-term savings on energy consumption and system maintenance.

Wired control included.



SAF 150E7
SAF 250E7
SAF 350E7
SAF 500E7
SAF 800E7
SAF 1000E7

Structure (SAF 800E7)

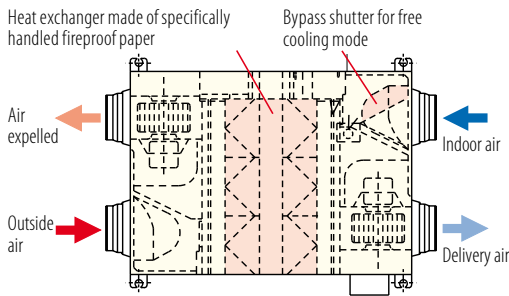

Operating principle in free cooling mode

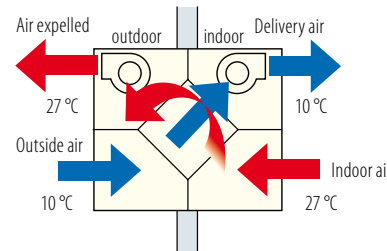

Operating principle in heat recovery mode

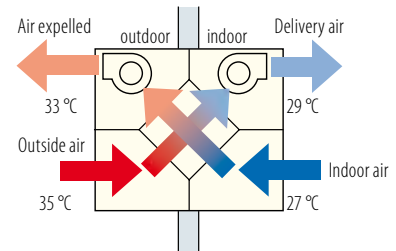

Warning: the drawings above represent only the operation principles; they do not represent the real position of the air inlets. For the correct position, refer to the drawing on the left.

Model			SAF 150E7	SAF 250E7	SAF 350E7	SAF 500E7	SAF 800E7	SAF 1000E7
Type	Enthalpy heat recovery unit							
Control (included)	Wired control							
Enthalpy exchange efficiency ¹	Cooling	%	63	63	66	62	65	65
	Heating	%	70	70	69	67	71	71
Heat exchange efficiency		%	75	75	75	75	75	75
Electrical data								
Power supply	Ph-V-Hz		1-220~240-50					
Power input	W		92~107	108~123	178~185	204~225	360~378	416~432
Rated absorbed current	A		0.42~0.45	0.49~0.51	0.77~0.81	0.93~0.94	1.58~1.64	1.80~1.89
Product specifications								
Outdoor dimensions	LxDxH	mm	970x467x270	882x599x270	1050x804x317	1090x904x317	1322x884x388	1322x1134x388
Net weight	Kg		25	29	49	57	71	83
Sound pressure level	Max	dB(A)	29	31.5	33	37.5	37.5	38.5
Volume of air treated	m ³ /h		150	250	350	500	800	1000
Fan static pressure	Max	Pa	80	105	140	120	140	105
Ducting flange	mm		ø98	ø144	ø144	ø194	ø242	ø242
Field of application	Max UR 85%	°C	-10~40					
Specific energy consumption ²	SEC	kWh/m ² y	-28.6	-	-	-	-	-
Class SEC ²			B	-	-	-	-	-

¹ Values related to the maximum speed of the 3 levels settable by wired remote control. ² Mandatory data for residential ventilation units (RVU) only.

Reference standards:

EU Ecodesign Directive 1253/2014 for non-residential ventilation units (NRVU) and residential ventilation (RVU).

EU Energy Labelling 1254/2014 Residential Ventilation Unit (RVU).



AIR HANDLING UNIT INTERFACE

AHU-KIT-SP2

The AHU controller for the air handling units works as an interface between MHI's commercial outdoor units and the air handling unit.

- Compact interface for RAC and PAC outdoor units.
- Capacity control via 0-10V / 4-20 mA signal.
- 3 digital input signals, and 4 output digital signals.
- Modbus connection (RS485).
- Cascade control for up to 16 units.
- Inlet air temperature control.



MAIN COMPONENTS

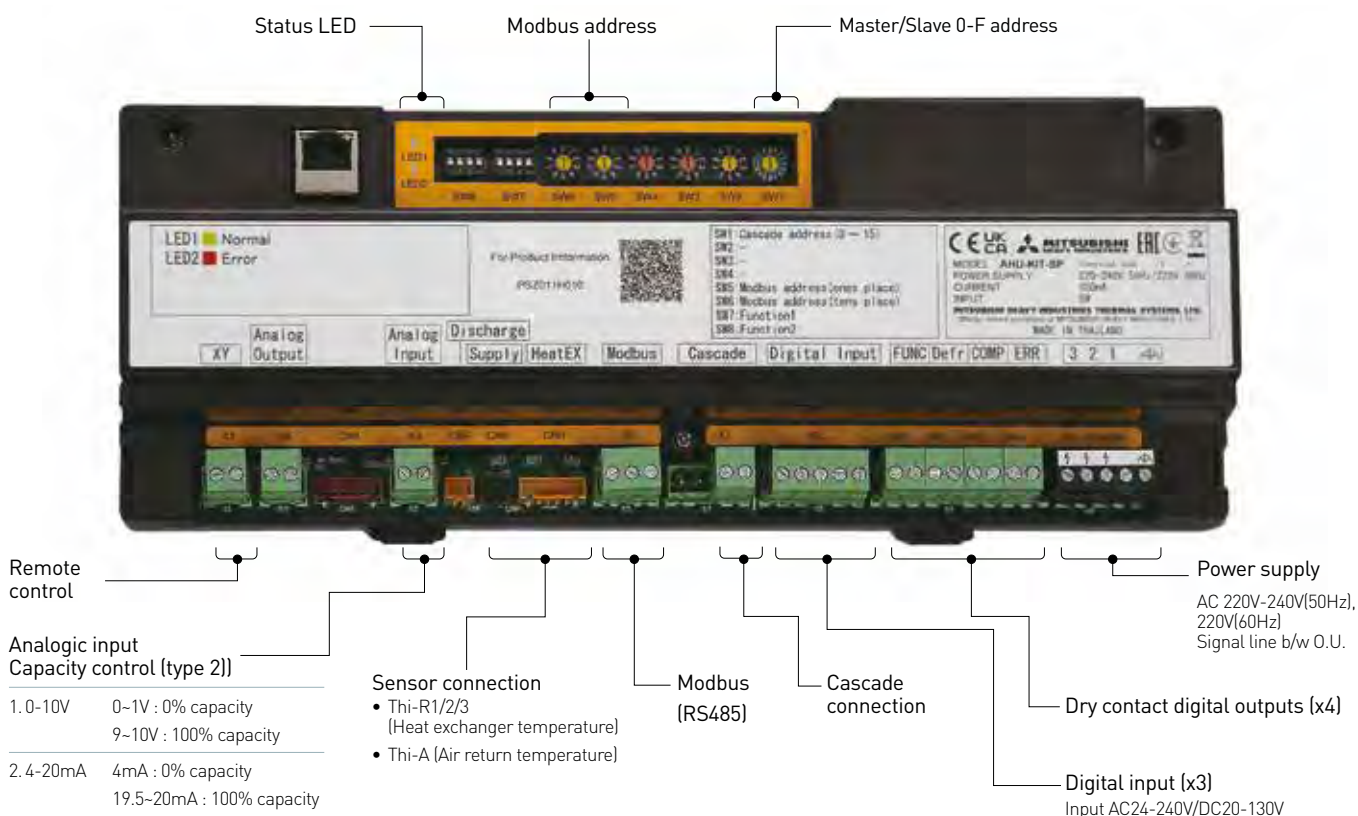

MAIN FEATURES

Model	AHU-KIT-SP2	
Dimensions (LxDxH)	290x57x109.5 mm	
External input	Capacity control	○ 0-10V DC, 4-20mA(0-100%)
	Cooling/Heating	○
	On/Off operation	○
	Emergency stop	○
External output	Comp On/Off	○
	Active/Stop	○
	Defrost On/Off	○
	Cooling/Heating mode	○
	Error	○
Modbus (RS-485)	○	
Cascade control	○ Max 16	
Safety standard	EN60335-1	

COMPATIBILITY

Capacity	R32
Small	SRC 40 ZSX-W1/SRC 50/60 ZSX-W3 FDC 71 VNX-W
	FDC 100/125/140 VNX-W
Medium	FDC 100/125/140 VSX-W
	FDC 100/125/140 VNA-W
	FDC100/125/140 VSA-W
Large	FDC 200/250/280 VSA-W

AIR HANDLING UNIT INTERFACE

SYSTEM EXAMPLES

GENERAL AHU

- 0-10V/4-20mA capacity control
- Various I/O for better control
- Optional command

Compatible with standard AHU controllers on the market.

Wide flexibility.

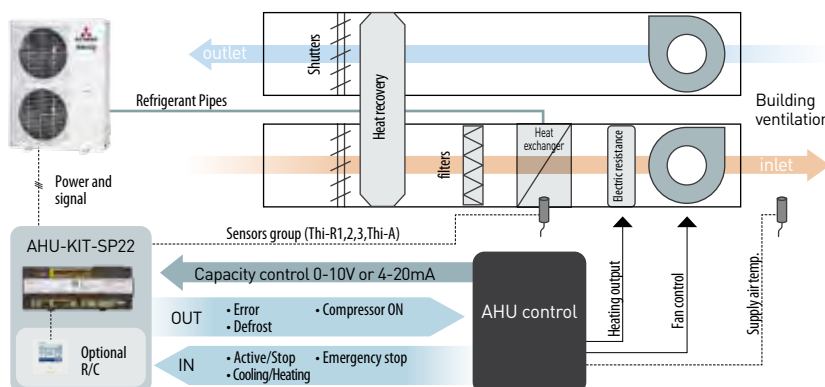

MODBUS AHU

- Modbus connection
- Same control as the external I / O
- Optional command

BMS connectivity without any additional device.

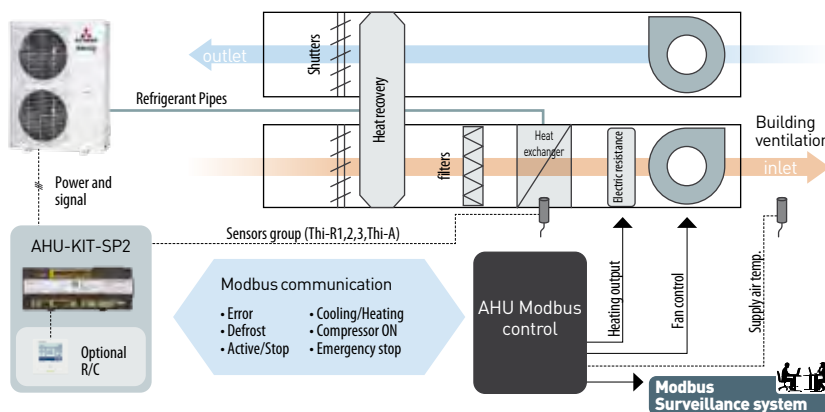

SIMPLE AHU

- Connecting the remote control
- Adequate external input / output

Simple autonomous management of the AHU through the temperature control set by RC.

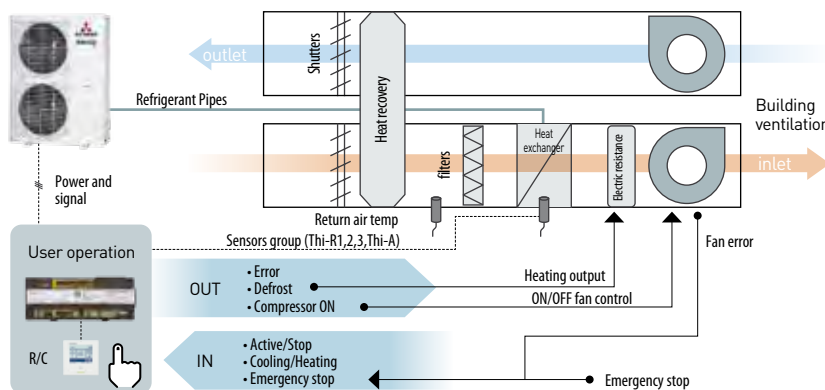

AHU GREAT CAPACITY

Cascade control offers a wide range of AHU capabilities with a smaller volume.

Multiple outdoor units increase the reliability and efficiency of the system.

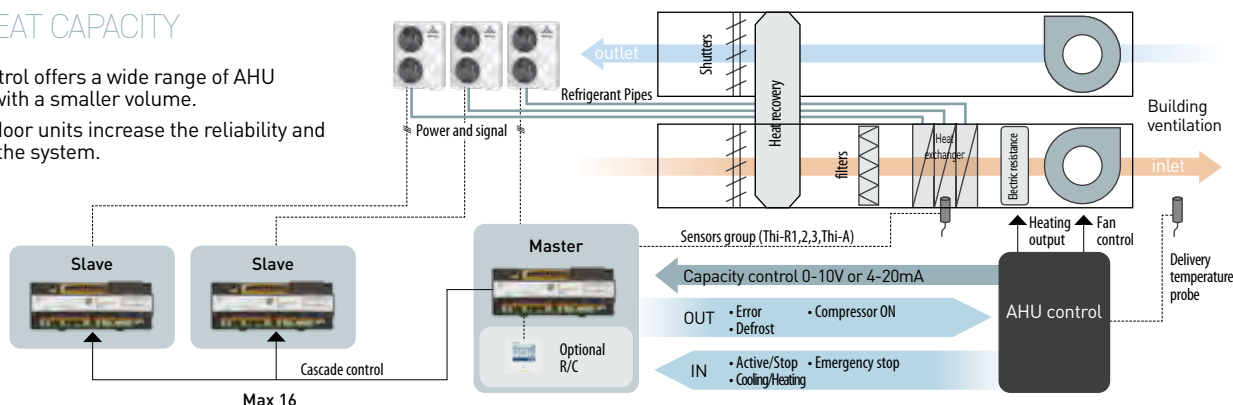



The background is a solid red color. It features several white lines that create a series of overlapping, elongated triangular shapes pointing towards the right. The lines are thin and intersect to form a complex, layered geometric pattern.

VRF MULTI SYSTEMS



VRF MULTI SYSTEMS

94 OUTDOOR UNITS LINE-UP

HEAT PUMP VRF MULTI SYSTEMS

- 98 KXZ2 VRF-T, THE NEW GENERATION OF MHI VRF
 - 100 HEAT PUMP KXZ SYSTEM
 - 113 KXZ MICRO VRF-T KXZ SYSTEM
 - 114 KXZ MICRO COMPACT
 - 116 KXZM MICRO LARGE CONNECTION
 - 118 KXZP MICRO SMART
 - 119 KXZ2 VRF-T SYSTEM
 - 125 KXZX2 HI-COP SYSTEM
-

HEAT RECOVERY VRF MULTI SYSTEMS

- 128 HEAT RECOVERY KXZR2 SYSTEM
 - 135 HEAT RECOVERY KXZR2
 - 139 HEAT RECOVERY KXZR2 HI-COP
-

WATER COOLED VRF MULTI SYSTEM

- 142 WATER COOLED VRF-T KXZW SYSTEM
 - 149 INDOOR UNITS LINE-UP
 - 150 HUMAN SENSOR
 - 151 INDOOR UNITS
 - 166 ENTHALPY HEAT RECOVERY UNIT
 - 167 POST-TREATMENT MODULAR UNIT
 - 168 CONTROL SYSTEM FOR AHU EEV-KIT
-

The complete control of technology is one of the pillars of MHI. KXZ models with VRF-T technology are an example: high-performance systems thanks to operating flexibility, high energy efficiency and easy installation.

I KXZ can meet the needs of an increasing number of applications in the commercial and industrial sectors

LINE UP

VRF MULTI SYSTEM

Heat pump outdoor units

KXZ MICRO COMPACT **VRF-T**



12.10 kW 4HP	14.00 kW 5HP	15.50 kW 6HP
FDC 121 KXZEN1 FDC 121 KXZES1	FDC 140 KXZEN1 FDC 140 KXZES1	FDC 155 KXZEN1 FDC 155 KXZES1

KXZM MICRO LARGE CONNECTION **VRF-T**



22.40 kW 8HP	28.00 kW 10HP	33.50 kW 12HP
FDC 224 KXZME1	FDC 280 KXZME1	FDC 335 KXZME1A

KXZP MICRO SMART **VRF-T**



22.40 kW 8HP	28.00 kW 10HP
FDC 224 KXZPE1	FDC 280 KXZPE1

KXZ2 **VRF-T**



28.00 kW 10HP	33.50 kW 12HP	40.00 kW 14HP	45.00 kW 16HP	47.50 kW 17HP	50.00 kW 18HP	56.00 kW 20HP
FDC 280 KXZE2	FDC 335 KXZE2	FDC 400 KXZE2	FDC 450 KXZE2	FDC 475 KXZE2	FDC 500 KXZE2	FDC 560 KXZE2



61.50 kW 22HP	67.00 kW 24HP	73.50 kW 26HP	80.00 kW 28HP	85.00 kW 30HP	90.00 kW 32HP	95.00 kW 34HP	100.00 kW 36HP	106.00 kW 38HP	112.00 kW 40HP
FDC 615 KXZE2 10+12	FDC 670 KXZE2 12+12	FDC 735 KXZE2 12+14	FDC 800 KXZE2 14+14	FDC 850 KXZE2 14+16	FDC 900 KXZE2 16+16	FDC 950 KXZE2 17+17	FDC 1000 KXZE2 18+18	FDC 1060 KXZE2 18+20	FDC 1120 KXZE2 20+20
FDC 280 KXZE2 FDC 335 KXZE2	FDC 335 KXZE2 FDC 335 KXZE2	FDC 335 KXZE2 FDC 400 KXZE2	FDC 400 KXZE2 FDC 400 KXZE2	FDC 400 KXZE2 FDC 450 KXZE2	FDC 450 KXZE2 FDC 450 KXZE2	FDC 475 KXZE2 FDC 475 KXZE2	FDC 500 KXZE2 FDC 500 KXZE2	FDC 500 KXZE2 FDC 560 KXZE2	FDC 560 KXZE2 FDC 560 KXZE2



120.00 kW 42HP	125.00 kW 44HP	130.00 kW 46HP	135.00 kW 48HP	142.50 kW 50HP	145.00 kW 52HP	150.00 kW 54HP	156.00 kW 56HP	162.00 kW 58HP	168.00 kW 60HP
FDC 1200 KXZE2 14+14+14	FDC 1250 KXZE2 14+14+16	FDC 1300 KXZE2 14+16+16	FDC 1350 KXZE2 16+16+16	FDC 1425 KXZE2 17+17+17	FDC 1450 KXZE2 17+17+18	FDC 1500 KXZE2 18+18+18	FDC 1560 KXZE2 18+18+20	FDC 1620 KXZE2 18+20+20	FDC 1680 KXZE2 20+20+20
FDC 400 KXZE2 FDC 400 KXZE2 FDC 400 KXZE2	FDC 400 KXZE2 FDC 400 KXZE2 FDC 450 KXZE2	FDC 400 KXZE2 FDC 450 KXZE2 FDC 450 KXZE2	FDC 450 KXZE2 FDC 450 KXZE2 FDC 450 KXZE2	FDC 475 KXZE2 FDC 475 KXZE2 FDC 475 KXZE2	FDC 475 KXZE2 FDC 475 KXZE2 FDC 500 KXZE2	FDC 500 KXZE2 FDC 500 KXZE2 FDC 500 KXZE2	FDC 500 KXZE2 FDC 500 KXZE2 FDC 560 KXZE2	FDC 500 KXZE2 FDC 560 KXZE2 FDC 560 KXZE2	FDC 560 KXZE2 FDC 560 KXZE2 FDC 560 KXZE2

KXZX2 Hi-COP **VRF-T NEW**



56.00 kW 20HP
FDC 560 KXZXE2 10+10
FDC 280 KXZE2 FDC 280 KXZE2



84.00 kW 30HP	89.50 kW 32HP	95.00 kW 34HP	100.50 kW 36HP
FDC 850 KXZXE2 10+10+10	FDC 900 KXZXE2 10+10+12	FDC 950 KXZXE2 10+12+12	FDC 1000 KXZXE2 12+12+12
FDC 280 KXZE2 FDC 280 KXZE2 FDC 280 KXZE2	FDC 280 KXZE2 FDC 280 KXZE2 FDC 335 KXZE2	FDC 280 KXZE2 FDC 335 KXZE2 FDC 335 KXZE2	FDC 335 KXZE2 FDC 335 KXZE2 FDC 335 KXZE2



107.00 kW 38HP
FDC 1060 KXZXE2 12+12+14
FDC 355 KXZE2 FDC 355 KXZE2 FDC 400 KXZE2



113.50 kW 40HP
FDC 1120 KXZXE2 12+14+14
FDC 355 KXZE2 FDC 400 KXZE2 FDC 400 KXZE2

Heat pump outdoor units

Connectable power of indoor units

KXZ MICRO COMPACT

HP	4	5	6
kW	12.1	14.0	15.5
EER	3.82	3.54	2.98
COP	3.91	3.83	3.62
max nb. connectable I.U.	8	10	10
power of connectable I.U.(%)	80%~150%		

KXZM MICRO LARGE CONNECTION

HP	8	10	12
kW	22.4	28.0	33.5
EER	4.01	3.54	3.13
COP	4.51	4.29	3.96
max nb. connectable I.U.	22	24	24
power of connectable I.U.(%)	50%~150%		

KXZP MICRO SMART

HP	8	10
kW	22.4	28.0
EER	4.00	3.56
COP	4.67	4.33
max nb. connectable I.U.	8	8
power of connectable I.U.(%)	50%~120%	

KXZ2

HP	10	12	14	16	17	18	20	22	24	26	28	30	32	34	36	38	40	42	44	46	48	50	52	54	56	58	60
kW	28.0	33.5	40.0	45.0	47.5	50.0	56.0	61.5	67.0	73.5	80.0	85.0	90.0	95.0	100.0	106.0	112.0	120.0	125.0	130.0	135.0	142.5	145.0	150.0	156.0	162.0	168.0
EER	3.86	3.73	3.64	3.22	3.40	3.57	3.20	3.79	3.73	3.68	3.64	3.41	3.22	3.40	3.57	3.36	3.20	3.64	3.48	3.34	3.22	3.40	3.46	3.57	3.43	3.31	3.20
COP	4.25	4.15	4.40	4.00	4.08	4.13	3.90	4.20	4.15	4.28	4.40	4.18	4.00	4.08	4.13	4.01	3.90	4.40	4.25	4.12	4.00	4.08	4.10	4.13	4.04	3.97	3.90
max nb. connectable I.U.	37	44	53	60	50	53	59	65	71	78	80	80	80	80	80	80	80	80	80	80	80	80	80	80	80	80	80
power of connectable I.U.	50~200%			50~160%									50~130%														

KXZX2 Hi-COP **NEW**

HP	20	30	32	34	36	38	40
kW	56.0	84.0	89.5	95.0	100.5	107.0	113.5
EER	3.86	3.86	3.81	3.77	3.73	3.70	3.67
COP	4.25	4.25	4.21	4.18	4.15	4.24	4.32
max nb. connectable I.U.	59	80	80	80	80	80	80
power of connectable I.U.	80~160%			80~130%			



Connectable power: 130% (36-60HP KXZ2)
Connectable power: 160%~200% (10-34HP KXZ2)



Connectable power: 130% (36-40HP KXZ2)
Connectable power: 160% (20-34HP KXZ2)

VRF MULTI SYSTEMS

Heat recovery outdoor units

KXZR2



22.40 kW 8HP	28.00 kW 10HP	33.50 kW 12HP
FDC 224 KXZRE2	FDC 280 KXZRE2	FDC 335 KXZRE2



40.00 kW 14HP	45.00 kW 16HP	47.50 kW 17HP	50.00 kW 18HP	56.00 kW 20HP	61.50 kW 22HP	67.00 kW 24HP
FDC 400 KXZRE2	FDC 450 KXZRE2	FDC 475 KXZRE2	FDC 500 KXZRE2	FDC 560 KXZRE2	FDC 615 KXZRE2	FDC 670 KXZRE2



73.50 kW 26HP	80.00 kW 28HP	85.50 kW 30HP	90.00 kW 32HP	95.00 kW 34HP	100.00 kW 36HP	106.00 kW 38HP	112.00 kW 40HP
FDC 735 KXZRE2 12+14	FDC 800 KXZRE2 14+14	FDC 850 KXZRE2 14+16	FDC 900 KXZRE2 16+16	FDC 950 KXZRE2 17+17	FDC 1000 KXZRE2 18+18	FDC 1060 KXZRE2 18+20	FDC 1120 KXZRE2 20+20
FDC 335 KXZRE2 FDC 400 KXZRE2	FDC 400 KXZRE2 FDC 400 KXZRE2	FDC 400 KXZRE2 FDC 450 KXZRE2	FDC 450 KXZRE2 FDC 450 KXZRE2	FDC 475 KXZRE2 FDC 475 KXZRE2	FDC 500 KXZRE2 FDC 500 KXZRE2	FDC 500 KXZRE2 FDC 560 KXZRE2	FDC 560 KXZRE2 FDC 560 KXZRE2



120.00 kW 42HP	125.00 kW 44HP	130.00 kW 46HP	135.00 kW 48HP	142.50 kW 50HP	145.00 kW 52HP	150.00 kW 54HP	156.00 kW 56HP	162.00 kW 58HP	168.00 kW 60HP
FDC 1200 KXZRE2 14+14+14	FDC 1250 KXZRE2 14+14+16	FDC 1300 KXZRE2 14+16+16	FDC 1350 KXZRE2 16+16+16	FDC 1425 KXZRE2 17+17+17	FDC 1450 KXZRE2 17+17+18	FDC 1500 KXZRE2 18+18+18	FDC 1560 KXZRE2 18+18+20	FDC 1620 KXZRE2 18+20+20	FDC 1680 KXZRE2 20+20+20
FDC 400 KXZRE2 FDC 400 KXZRE2 FDC 400 KXZRE2	FDC 400 KXZRE2 FDC 400 KXZRE2 FDC 450 KXZRE2	FDC 400 KXZRE2 FDC 450 KXZRE2 FDC 450 KXZRE2	FDC 450 KXZRE2 FDC 450 KXZRE2 FDC 450 KXZRE2	FDC 475 KXZRE2 FDC 475 KXZRE2 FDC 475 KXZRE2	FDC 475 KXZRE2 FDC 475 KXZRE2 FDC 500 KXZRE2	FDC 500 KXZRE2 FDC 500 KXZRE2 FDC 500 KXZRE2	FDC 500 KXZRE2 FDC 500 KXZRE2 FDC 560 KXZRE2	FDC 500 KXZRE2 FDC 560 KXZRE2 FDC 560 KXZRE2	FDC 560 KXZRE2 FDC 560 KXZRE2 FDC 560 KXZRE2

KXZR2 Hi-COP **VRF-T NEW**



45.00 kW 16HP	50.00 kW 18HP	56.00 kW 20HP	61.50 kW 22HP	67.00 kW 24HP
FDC 450 KXZRXE2 8+8	FDC 500 KXZRXE2 8+10	FDC 560 KXZRXE2 10+10	FDC 615 KXZRXE2 10+12	FDC 450 KXZRXE2 12+12
FDC 224 KXZRE2 FDC 224 KXZRE2	FDC 224 KXZRE2 FDC 280 KXZRE2	FDC 280 KXZRE2 FDC 280 KXZRE2	FDC 280 KXZRE2 FDC 335 KXZRE2	FDC 335 KXZRE2 FDC 335 KXZRE2



73.5 kW 26HP	80.00 kW 28HP	85.00 kW 30HP	90.00 kW 32HP	95.00 kW 34HP	100.00 kW 36HP
FDC 735 KXZRXE2 8+8+10	FDC 800 KXZRXE2 8+10+10	FDC 850 KXZRXE2 10+10+10	FDC 900 KXZRXE2 10+10+12	FDC 950 KXZRXE2 10+12+12	FDC 1000 KXZRXE2 12+12+12
FDC 224 KXZRE2 FDC 224 KXZRE2 FDC 280 KXZRE2	FDC 224 KXZRE2 FDC 280 KXZRE2 FDC 280 KXZRE2	FDC 280 KXZRE2 FDC 280 KXZRE2 FDC 280 KXZRE2	FDC 280 KXZRE2 FDC 280 KXZRE2 FDC 335 KXZRE2	FDC 280 KXZRE2 FDC 335 KXZRE2 FDC 335 KXZRE2	FDC 335 KXZRE2 FDC 335 KXZRE2 FDC 335 KXZRE2

VRF MULTI SYSTEMS

Water cooled outdoor units

KXZW WATER **VRF-T**



22.40 kW 8HP FDC 224 KXZWE1	28.00 kW 10HP FDC 280 KXZWE1	33.50 kW 12HP FDC 335 KXZWE1
--	---	---



45.00 kW 16HP FDC 450 KXZWE1 8+8 FDC 224 KXZWE1 FDC 224 KXZWE1	50.00 kW 18HP FDC 500 KXZWE1 8+10 FDC 224 KXZWE1 FDC 280 KXZWE1	56.00 kW 20HP FDC 560 KXZWE1 10+10 FDC 280 KXZWE1 FDC 280 KXZWE1	61.50 kW 22HP FDC 615 KXZWE1 10+12 FDC 280 KXZWE1 FDC 335 KXZWE1	67.00 kW 24HP FDC 670 KXZWE1 12+12 FDC 335 KXZWE1 FDC 335 KXZWE1
--	---	--	--	--



73.00 kW 26HP FDC 730 KXZWE1 8+8+10 FDC 224 KXZWE1 FDC 224 KXZWE1 FDC 280 KXZWE1	77.50 kW 28HP FDC 775 KXZWE1 8+10+10 FDC 224 KXZWE1 FDC 224 KXZWE1 FDC 280 KXZWE1	85.00 kW 30HP FDC 850 KXZWE1 10+10+10 FDC 280 KXZWE1 FDC 280 KXZWE1 FDC 280 KXZWE1	90.00 kW 32HP FDC 900 KXZWE1 10+10+12 FDC 280 KXZWE1 FDC 280 KXZWE1 FDC 335 KXZWE1	95.00 kW 34HP FDC 950 KXZWE1 10+12+12 FDC 280 KXZWE1 FDC 335 KXZWE1 FDC 335 KXZWE1	100.00 kW 36HP FDC 1000 KXZWE1 12+12+12 FDC 335 KXZWE1 FDC 335 KXZWE1 FDC 335 KXZWE1
---	--	---	---	---	---

Heat recovery outdoor units

Connectable power of indoor units

KXZR2

HP	8	10	12	14	16	17	18	20	22	24	26	28	30	32	34	36	38	40	42	44	46	48	50	52	54	56	58	60
kW	22.4	28.0	33.5	40.0	45.0	47.5	50.0	56.0	61.5	67.0	73.5	80.0	85.0	90.0	95.0	100.0	106.0	112.0	120.0	125.0	130.0	135.0	142.5	145.0	150.0	156.0	162.0	168.0
EER	3.89	3.79	3.47	3.46	3.11	3.20	3.29	2.90	2.88	2.62	3.47	3.46	3.27	3.11	3.20	3.29	3.07	2.90	3.46	3.33	3.21	3.11	3.20	3.23	3.29	3.14	3.01	2.90
COP	4.25	4.08	3.97	4.10	3.95	4.07	3.94	3.75	3.81	3.61	4.04	4.10	4.02	3.95	4.07	3.94	3.84	3.75	4.10	4.04	4.00	3.95	4.07	4.02	3.94	3.87	3.81	3.75
max nb. connectable I.U.	29	37	44	53	60	50	53	59	65	71	78	80	80	80	80	80	80	80	80	80	80	80	80	80	80	80	80	80
power of connectable I.U.%	50~200%			50~160%									50~130%															

KXZRX2 Hi-COP **NEW**

HP	16	18	20	22	24	26	28	30	32	34	36	
kW	45.0	50.0	56.0	61.5	67.0	73.5	80.0	85.0	90.0	95.0	100.0	
EER	3.91	3.80	3.79	3.61	3.47	3.89	3.89	3.83	3.68	3.56	3.45	
COP	4.27	4.12	4.08	4.02	3.97	4.22	4.21	4.13	4.06	4.00	3.95	
max nb. connectable I.U.	60	53	59	65	71	78	80	80	80	80	80	
power of connectable I.U.%	80~200			80~160%					80~130			

Water cooled outdoor units

Connectable power of indoor units

KXZW WATER

HP	8	10	12	16	18	20	22	24	26	28	30	32	34	36
kW	22.4	28.0	33.5	45.0	50.0	56.0	61.5	67.0	73.0	77.5	85.0	90.0	95.0	100.0
EER	5.30	4.87	4.12	5.30	5.09	4.87	4.49	4.11	5.14	5.00	4.86	4.62	4.38	4.12
COP	5.90	6.18	5.95	5.90	6.04	6.18	6.05	5.95	5.98	6.08	6.17	6.10	6.02	5.96
max nb. connectable I.U.	22	28	33	44	50	56	61	67	72	78	80	80	80	80
power of connectable I.U.%	50~150%													

KXZ2 VRF-T, THE NEW GENERATION OF MHI VRF

VRF systems offer a consolidated solution for the market and for a technological point of view, after having contributed to the transformation of environmental conditioning, VRF systems are now able to guarantee efficient and competitive solutions.

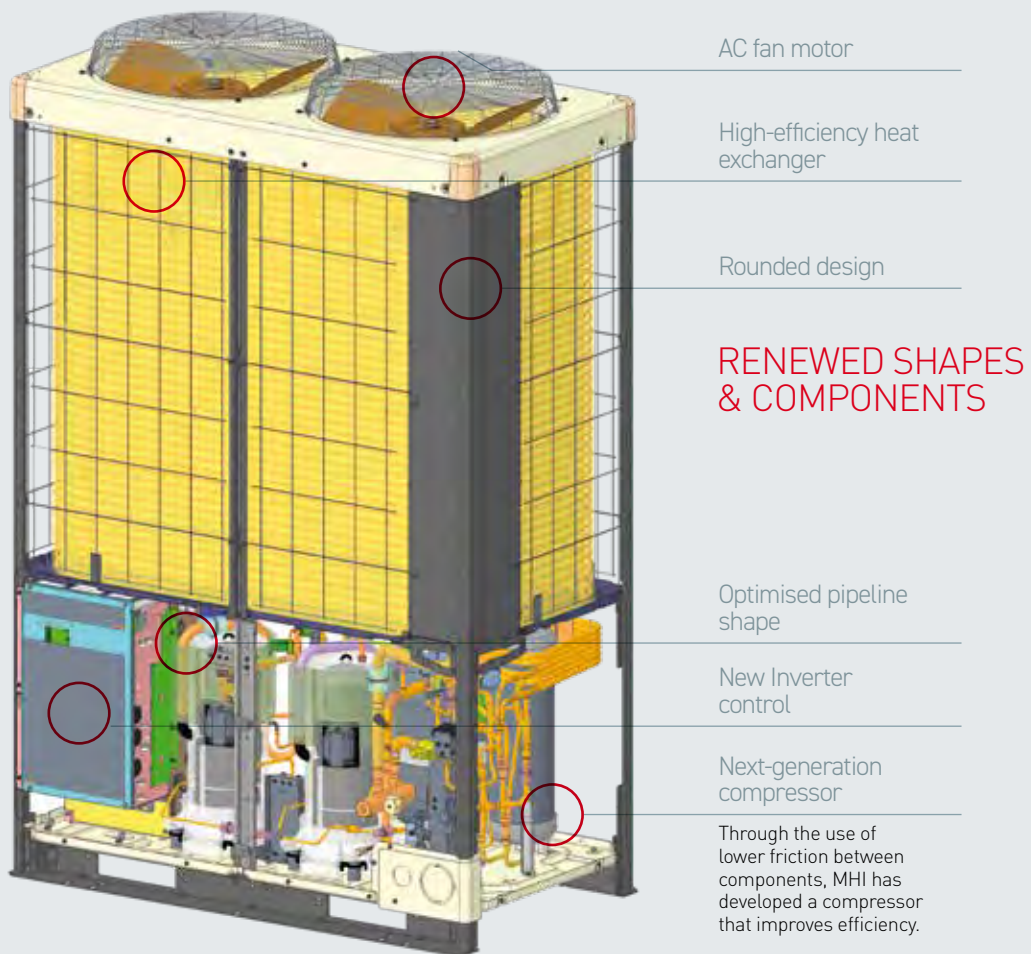

HIGH SPLITTING DISTANCE

A maximum height difference between indoor units has been increased to 30 metres, and a maximum height difference between outdoor and indoor units has been increased to 90 metres.

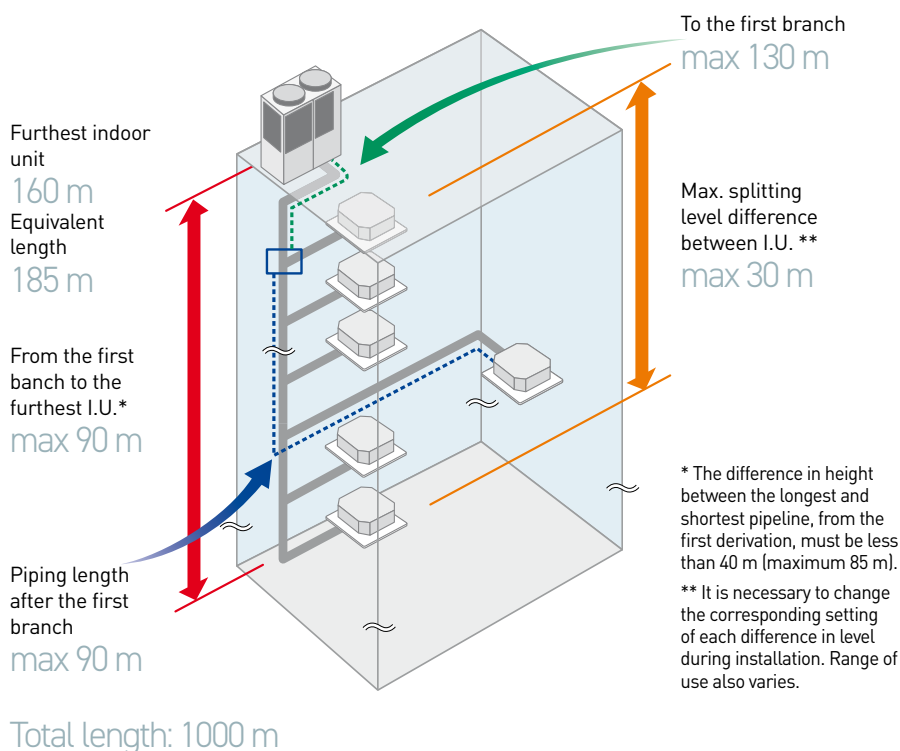

INCREASE IN THE NUMBER OF INDOOR UNITS THAT CAN BE CONNECTED

HP	10	12	14	16	17	18	20	22	24	26	28	30	32	34
max nb. connectable I.U.	37	44	53	60	50	53	59	65	71	78	80	80	80	80
HP	36	38	40	42	44	46	48	50	52	54	56	58	60	
max nb. connectable I.U.	80	80	80	80	80	80	80	80	80	80	80	80	80	80



LOW TEMPERATURE POWER CONTROL

The new **continuous control of heating capacity** improves the management of power consumption at low outside temperatures.

The continuous control regulates the pressure automatically, thereby increasing the heating period and decreasing the defrosting period.

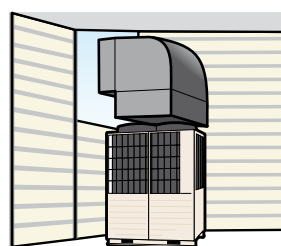

INSTALLATION FLEXIBILITY

max 85 Pa

The static pressure reaches up to 85 Pa.

HEAT PUMP KXZ SYSTEM

Innovative technology for evolutionary standards in the air conditioning of industrial and commercial environments. Functional control and innovative components make this system technology more efficient.

HIGH PERFORMANCE

- Refrigerant temperature control.
- High efficiency.
- High COP values.
- 34% energy savings.

EASY MANAGEMENT

- Compact design.
- Design flexibility.
- Quick installation.
- Easy maintenance.
- Minimum operating costs.



MICRO COMPACT
MICRO LARGE CONNECTION
MICRO SMART



KXZ2

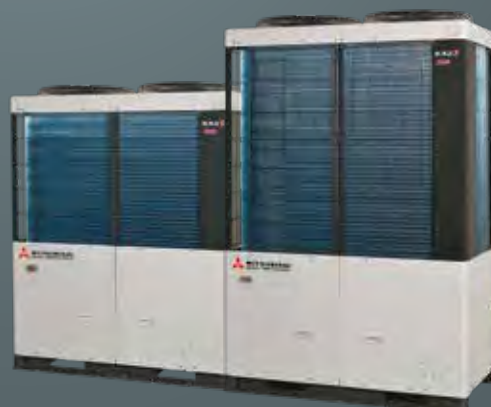

KXZX2 Hi-COP



HEAT PUMP KXZ SYSTEM

Mitsubishi Heavy Industries' KXZ heat pump series with VRF-T technology is distinguished by the possibility of controlling the refrigerant temperature in the various stages of operation, improving the performance levels compared to traditional systems. KXZ is a unique system that provides an excellent performance both cooling and heating. Maximum level of design flexibility, reduction of energy consumption and advanced operating functions, centralised management of system and above all Hi-COP (KXZX), complete the profile of the KXZ series, which ensures reliability and efficiency over time.

WIDE DEPTH OF RANGE

Outdoor units

Up to 80 connectable indoor units. 5 product lines from 4 to 60HP (12.1-168.0 kW): Micro Compact, Micro Large Connection, Micro Smart, KXZ2 and Hi-COP. Mitsubishi air conditioners with VRF-T technology all have double vertical fan and three-phase power supply. They can be installed also in twin combination, with only one refrigerant circuit. The total splitting distance reaches 1000 m.

Indoor units

14 types of units for a total of 81 models.

The variety of types and capacities ensures an offer capable of meeting all the design and installation requirements.

APPLICATION IN NZEB SOLUTION

KXZ system with VRF-T technology is particularly suitable for applications on buildings constructed according to ZEB logic. In fact, the "zero-energy" buildings, realized according to ZEB logic, have the characteristics of reducing the energy consumption, but also of producing the required energy by renewable energy sources, since their goal is the self-sufficiency.

To construct ZEB buildings, it is essential that energy efficiency is put as a priority condition since the construction project, taking into consideration all the components that contribute to the final result: heating, cooling, photovoltaic systems and domestic hot water, until the energy management of the entire structure. To achieve this result, one of the main application solutions is constituted by heat pumps, such as those of KXZ system with VRF-T technology.

WHY CHOOSE THE KXZ SYSTEM?

ENERGY SAVINGS UP TO 34%

With VRF-T technology, refrigerant temperature control during the condensation and evaporation phases in the refrigerant system ensures energy savings up to 34% in cooling mode during the partial loads, compared to the traditional VRF models.

Traditional system cooling operation

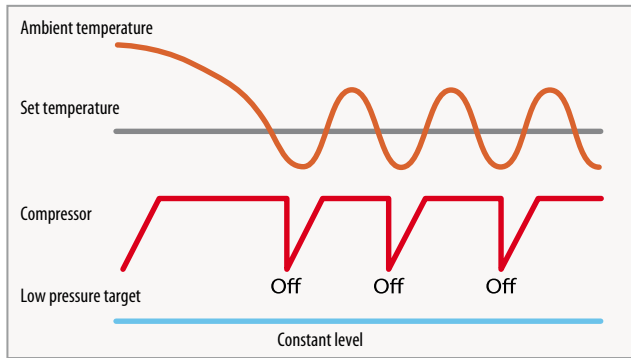

In a traditional system, the refrigerant target pressure to be maintained is constant. As soon as room temperature reaches the temperature set by the user, the compressor is forced to decrease and increase the rpm by on-off cycles that affect the overall efficiency and performance.

KXZ system cooling operation with activation of VRF-T mode

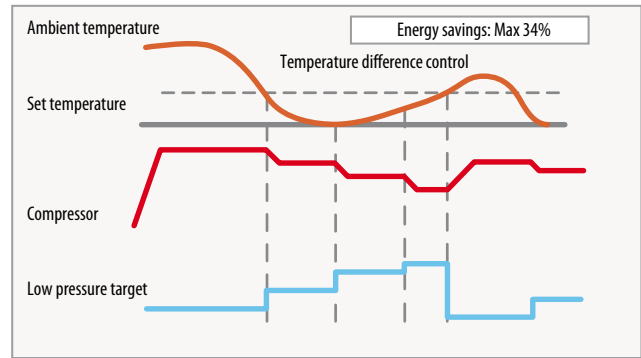

With the new VRF-T, the refrigerant target pressure to be maintained is not constant, but adjusts proportionally to the difference between the room temperature and the desired temperature. This allows the Inverter compressors to modulate the rpm without ever stopping, thus expressing the maximum efficiency for a global energy saving operation.

ELECTRICAL WINDING OF THE COMPRESSOR FOR HIGH PERFORMANCE AND EFFICIENCY

The compacted design of the motor winding significantly improves the electrical performance, which results in increased efficiency, especially in partial loads with a consequent increase in seasonal efficiency.

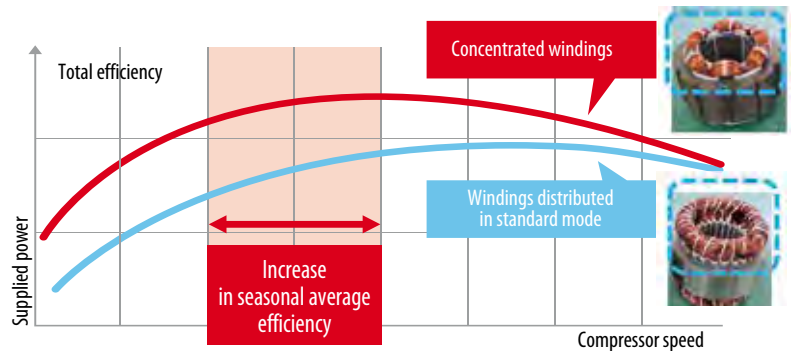

DC INVERTER COMPRESSOR, FOR HIGH SCOP

The multi-port discharge system of the compressor guarantees better volumetric performance. Optimisation of the pressure control, in particular to the medium compressor operation frequencies, with consequent improvement to seasonal efficiency performance.

All KXZP/KXZ2/KXZX outdoor units use DC Inverter compressors only.

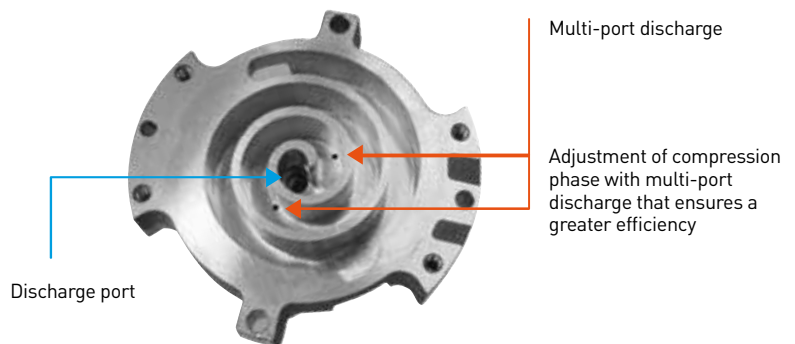

WHY CHOOSE THE KXZ SYSTEM?

MORE EFFICIENT REFRIGERANT DISTRIBUTOR

The new configuration composed of distributor and capillary has optimized the diffusion of refrigerant in the new heat exchanger, with a further increase in the total efficiency of system.

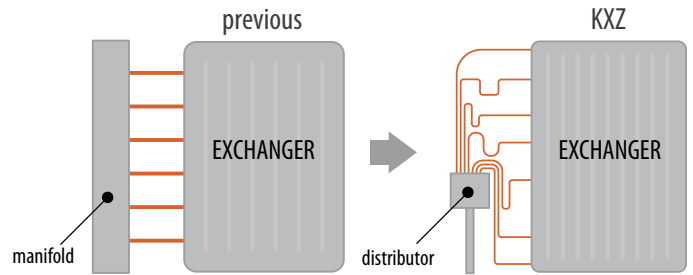

OIL LEVEL CONTROL

Mitsubishi oil level adjustment technology for the combination of two or three outdoor units allows operation with constant balancing, maintaining the units' performance and guaranteeing a long system life.

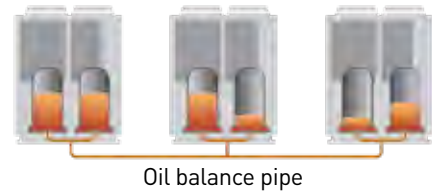

POWER OUTPUT CONTROL

The power output can be controlled and selected by the function of power cut through RC-EX3A, remote control, to obtain a greater energy saving.

The 4-step power control (80-60-40-0%) is available, that can be programmed in hour intervals, every week.

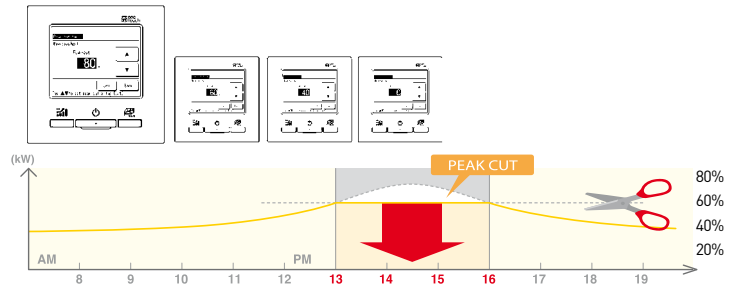

INVERTER CONTROL (VECTOR)

The use of a new vector Inverter control, allows the user to:

- Increase the response speed of compressors at low and high speed.
- Re-create exactly the sinusoidal waveform of the voltage applied.
- Increase the efficiency of compressors at low speed and partial loads.

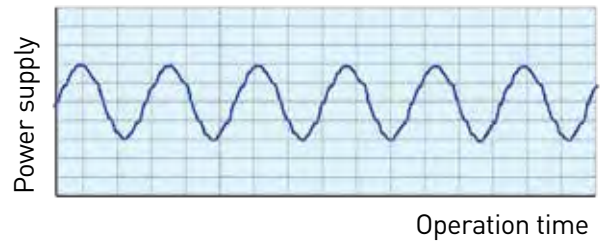

FAN DESIGN WITH SERRATED EDGES

Fan blades with serrated edges that treat a greater air volume, offering low resistance to air and reducing energy consumption.



DC FAN MOTOR

The use of DC fan motor can help achieve excellent efficiency, with an increase higher than 60% compared to the previous models.

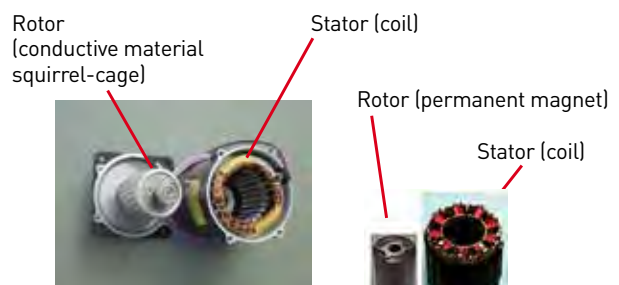

ADVANTAGES FOR DESIGNERS

The system design phase requires flexible and advanced solutions, able to respond to each manufacturing solution.

Below is a list of all the points that make KXZ - VRF-T a system equipped with all the advantages that meet new design standards.



1. HIGH SPLITTING DISTANCE, FLEXIBLE DESIGN 1000 m (10~60HP, KXZ2 series)

There was an increase in the split difference between indoor units up to a maximum of 30 metres, allowing the indoor units to be placed on more than one level.

A 90-metre split level difference has been added between the outdoor and indoor units.

The further indoor unit (160 m) or total length (1000 m) contribute to the flexibility of the system.

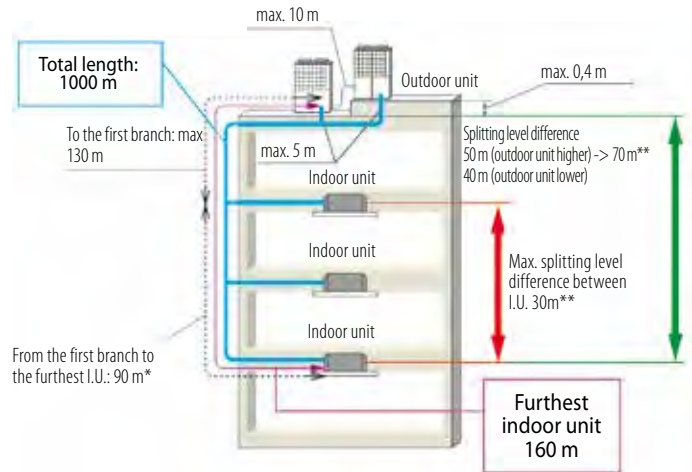

* The difference in height between the longest and shortest pipeline must be less than 40 m (maximum 85 m)

** It is necessary to change the setting of each height during installation. Range of use also varies.

2. EASY TRANSPORT & INSTALLATION

Thanks to the significant reduction in the weight and overall plan dimensions, the KXZM outdoor units can be easily transported in a lift capable of containing 6 people (if permitted by the condominium regulations), with a consequent reduction in costs, time and working procedures.

The outdoor units in the KXZ and KXZX series have a functional base, which makes it easier to lift and transport them to the place of installation.

They are also characterised by the same overall plan dimensions, which facilitates the installation of the machines in series as well as optimising times and procedures for maintenance and replacement of each unit.

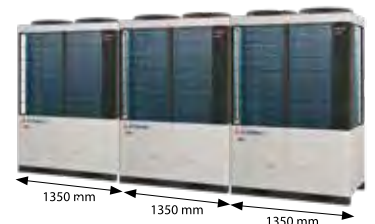
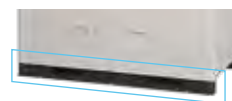
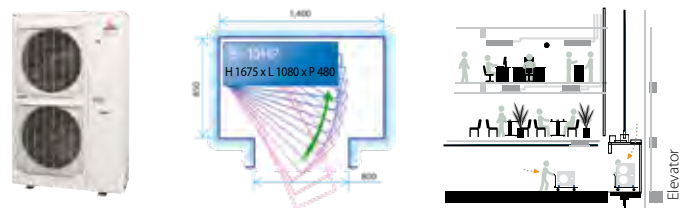
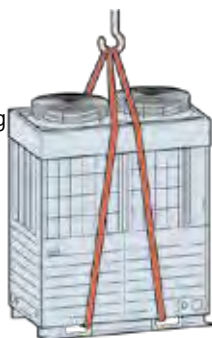

ADVANTAGES FOR DESIGNERS

3. WIDE OPERATING RANGE, FLEXIBLE DESIGN

The KXZP series enables operation in heating mode with an outdoor temperature limit of -20°C and a cooling range up to 50°C . The other series reach 46°C and 43°C .

The KXZ Micro series allows heating operation with an external temperature limit of -20°C to 20°C . The other series have operating ranges between -20°C and 15.5°C .

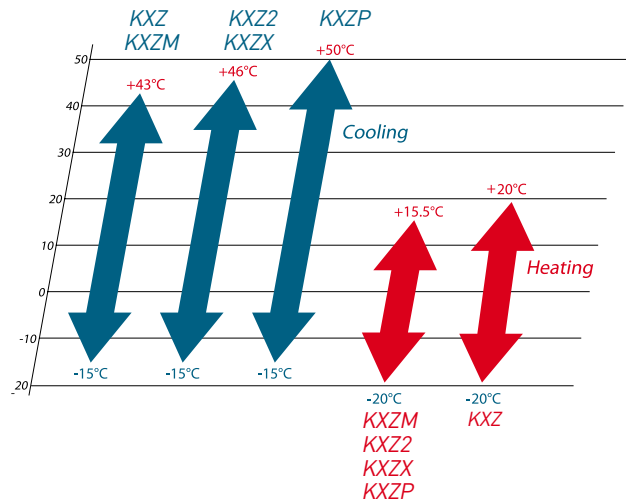

4. BLUE FIN FUNCTION, AGAINST CORROSION OF THE HEAT EXCHANGERS

The particular coating of the heat exchanger louvres guarantees perfect resistance to corrosion and deterioration caused by atmospheric agents.



5. EXTERNAL STATIC PRESSURE FROM 35 PA FOR KXZ MICRO SMART

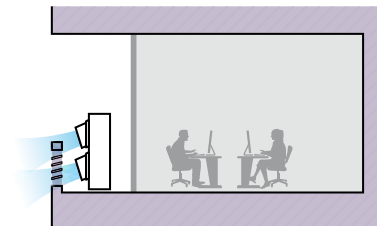

6. OUTDOOR FAN MOTORS FUNCTION

Function with pressure head useful for ducting.

7. AUTOMATIC FUNCTION FOR REDUCED WEAR

The outdoor units with multiple compressors are subject to wear. This automatic function balances the automatic operation of compressors, depending on the hours of use.

8. ADDITIONAL FUNCTIONS:

- POWER DEMAND OPTION: the outdoor unit's rated power can be decreased.
- SEASONAL OPTION: a summer/winter season function change can be set.
- OUTPUT SIGNAL OPTION: indicates the on or error signal.

ADVANTAGES FOR INSTALLERS

Installing KXZ units in a system means having an installation able to satisfy the most varied requirements, thanks to useful functions and important features which make the life of the system easier to manage, during both installation and maintenance.



1. MONITORING FUNCTION

Thanks to a simple navigation menu, the displays on the outdoor unit boards are able to show all the vital parameters of the unit and any error messages for prompt intervention.

Connect a PC to the RS 232C port, available on the board, to monitor and save all the historical data of system for assistance and control activities. Our Mente PC software must be installed on the PC.

8-60HP



2. BACK UP FUNCTION

In the event that one of them malfunctions, the unit can however operate at reduced capacity. In multiple combinations of high capacity of two or three outdoor units, unit malfunction does not affect total operation of the system, which will continue to operate in a partial manner.

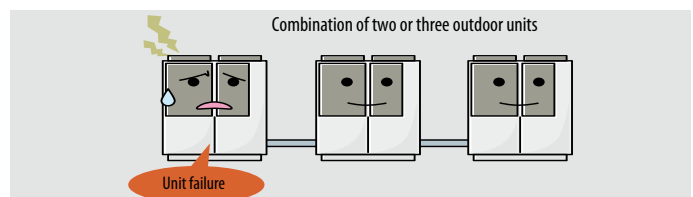
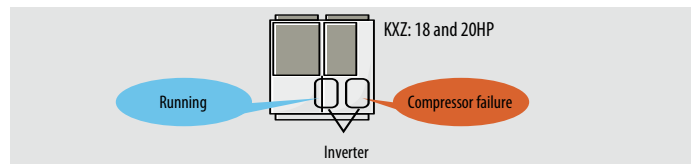

3. EASY ACCESS TO THE ELECTRICAL BOX FOR MAINTENANCE

Inverter service and maintenance are now easier thanks to the new control box with a structure of 3 levels (KXZ) and 2 levels (KXZP SMART) with a hinged connection.

KXZ



KXZP SMART



ADVANTAGES FOR INSTALLERS

4. EASE OF USE

Position of pipes:

- 1) from the front
- 2) to the right
- 3) below
- 4) from the back

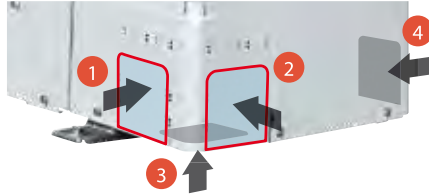

New holes for thread insertion, to prevent falls

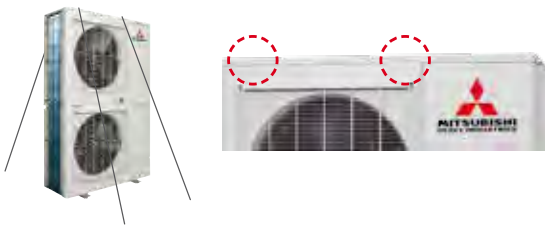

Service panel maintenance

Unit installation and maintenance of unit are easier thanks to the reduced number of fixing screws on the service panel (from 5 to 2).

5 → 2



Clear rain cover



5. GAS TESTING FUNCTION

This function provides for a procedure capable of verifying whether the amount of refrigerant gas contained inside the system is correct.

The positive side to this is evident, as it optimises the use of gases that are harmful to the environment, as required by current legislation.

6. AUTO-ADDRESSING FUNCTION

Simply power the unit and this automatic function will facilitate intelligent connection between multiple units.

7. ADDITIONAL FUNCTIONS

- Simplified test procedure.
- Simplified function for wiring.
- Easy function for refrigerant installation and maintenance.
- The unit's distinguishing feature is that of being Easy Service, as it permits easy maintenance, easy electronic check and feedback by the protection system in case of malfunctions.



ADVANTAGES FOR USERS

A complete system in terms of comfort and smart control, that can be customised to meet the needs of all types of buildings, stores or housing solutions.

KXZ with VRF-T technology, designed with integration in mind, is an ideal system because it allows end users to achieve maximum energy efficiency as well as manage several systems, with ease of use guaranteed by leading control standards.



1. REDUCED COSTS

Cost reduction is an advantage that relates to several aspects:

- savings in management costs;
- savings in maintenance costs;
- savings on annual consumption thanks to high energy efficiency.



2. A COMPLETE SOLUTION

Only one system for heating, cooling and management control that can fit any solution.

3. MAXIMUM RELIABILITY

- Well-tested systems in every condition.
- After-sales service and service network always available.
- Prompt availability of spare parts.

4. INTEGRATION & BUILDING AUTOMATION

The KXZ- VRF-T system boasts integration with home automation systems or Building Automation for easier and more uniform management.

5. BEST ENERGY CLASS

Being in heat pump, the use of KXZ- VRF-T improves building energy classifications with higher scores, thus increasing building value.



REFRIGERANT CONNECTIONS

VRF-T systems are manufactured to the highest standards of quality and reliability and it is therefore essential for the installation procedures and materials to have the same qualitative features, to ensure trouble-free long-term operation. It is advisable to use high quality copper refrigerant piping, in coils or in straight, semi-rigid lengths. The copper piping should be chosen considering the higher operating pressure of R410A refrigerant gas and the increased pressure circulating in the system produced by reverse cycle operation. All materials used must comply with European standards (EN 12735). The branch pipe kits supplied must be used to connect the indoor units and the manifold kits must be used to connect the outdoor units (if necessary). It is forbidden to use standard accessories (elbow pipes, T-joints etc.). The branch pipes must be installed according to manufacturer guidelines and must allow a continuous flow of refrigerant in accordance with European standard E378: 2017.

All connecting welds must be made under slight nitrogen pressure to prevent the oxidation of the inner surface of the copper pipes. During installation, no accidental entry of condensate, dust or any other contaminant must be permitted. Once installation is complete, a leak test must be carried out to check for refrigerant leaks with pressurised nitrogen. The ends of the pipe must be bent and welded and an appropriate service valve affixed.

Additional refrigerant charge

Only R410A refrigerant gas must be used, and this must be added by weight using an electronic meter. The amount of additional refrigerant must be carefully calculated according to the manufacturer’s guidelines, defined by the length and diameter of each section of the system piping.

KXZ2 SINGLE OUTDOOR UNIT

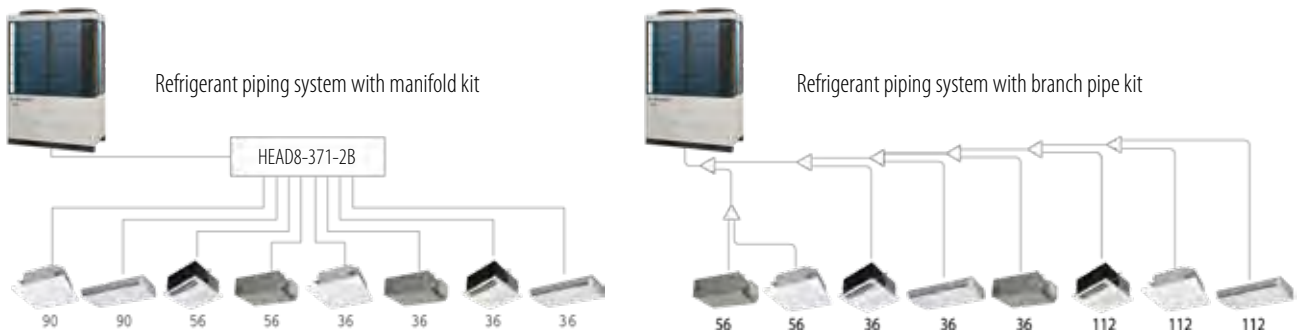

KXZ2 REFRIGERANT CONNECTIONS

KXZ2 COMBINED OUTDOOR UNITS

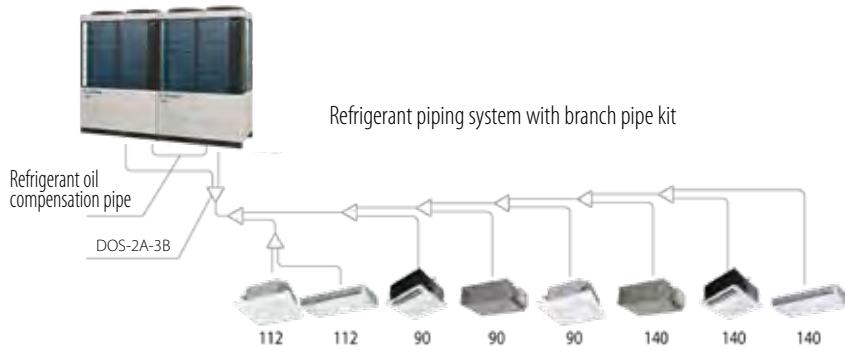

Set of outdoor unit branch pipes	
Outdoor unit	Set of branch pipes
2 units (for 615~1120)	DOS-2A-3B
3 units (for 1200~1680)	DOS-3A-3I

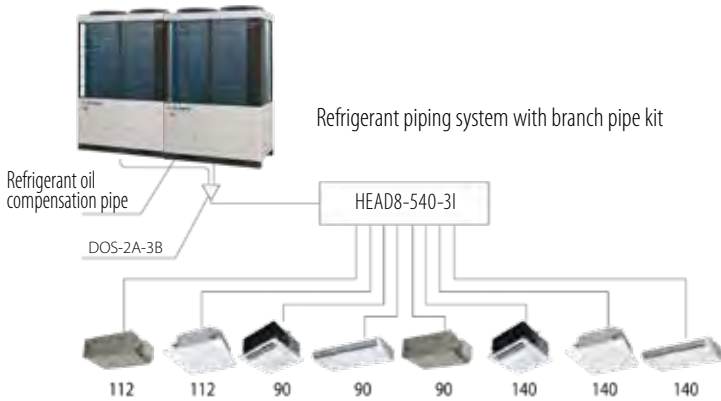

Total capacity of indoor units	Set of branch pipes	Set of manifolds	
		Model	Branch pipes
~179	DIS-22-1B	HEAD4-22-1B	Max. 4 units
180~370	DIS-180-1B	HEAD6-180-1B	Max. 6 units
371~539	DIS-371-1B	HEAD8-371-2B	Max. 8 units
540~	DIS-540-3B	HEAD8-540-3I	Max. 8 units

HP		10	12	14	16	17	18	20	22	24	26	28	30	32	34	36	38	40	42	44	46	48	50	52	54	56	58	60
Liquid side	Furthest I.U. =<90 m	ø9.52	ø12.7				ø15.88				ø19.05																	
Gas side		ø22.22	ø28.58				ø34.92																					
Liquid side	Furthest I.U. =>90 m	ø12.7				ø15.88				ø19.05				ø22.22														
Gas side		ø22.22	ø28.58				ø34.92																					

Branch pipes



DIS-22-1B/DIS-180-1B



DIS-371-1B/DIS-540-3B

Manifolds



HEAD6-180-1B



DOS-2A-3B/DOS-3A-3I

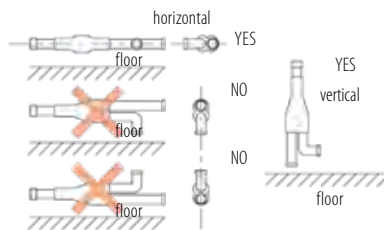

WIRING

VRF MHI systems require highly simplified electrical connections to the indoor units, thanks to a control circuit that uses 2 non-polarised conductors. The outdoor unit can be accessed from all sides for electrical connections (front, rear, bottom, right and left). A separate single-phase or three-phase power supply must be brought in for outdoor and indoor units, depending on the product specification.

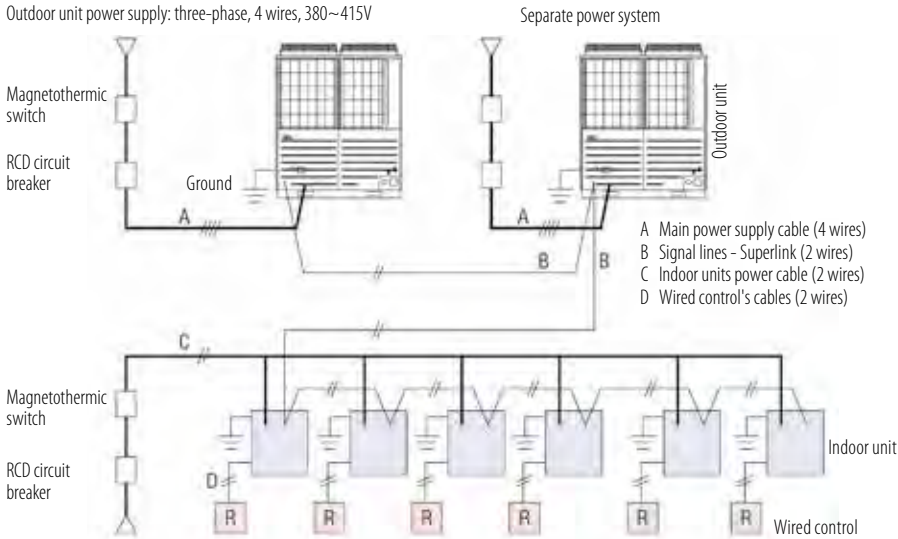

Indoor unit power supply: single-phase 220~240V
 CAUTION: if the RCD is dedicated solely to protecting against leakage to earth, it will be necessary to install a magnetothermal breaker.

SIGNAL LINE

The signal line that connects the outdoor unit to the indoor units is 5 VDC and uses 2 non-polarised conductors marked A1 and B1. For the signal line with 2 conductors, use shielded cables measuring 0.75 or 1.50 mm². Earth the shield on all the indoor and outdoor units.

If using combined outdoor units, connect:

	0.75 mm ²	1.50 mm ²
~1000 mm	YES	YES
1000~1500 mm	YES	NO

- The signal line between indoor and outdoor units, and the signal line between outdoor units that belong to the same refrigerant line, to A1 and B1.
- The signal line between outdoor units belonging to a different refrigerant line to A2 and B2.

IMPORTANT: star connections on the signal lines are not permitted.

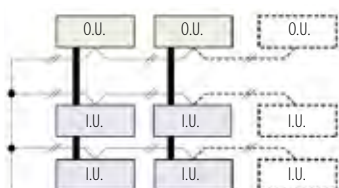

Single outdoor unit

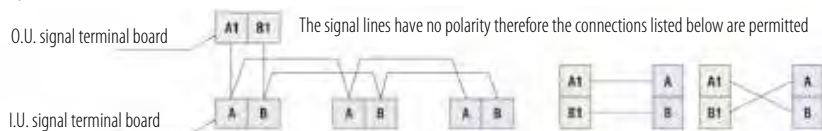

Combined outdoor units

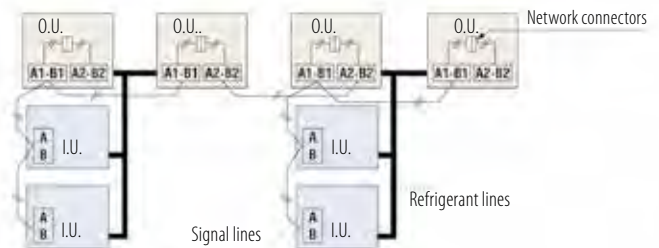

The maximum number of indoor units that can be connected to a signal line is 128, and it is possible to create groups of outdoor and/or indoor units connected to the same outdoor unit or to separate outdoor units, as long as they are connected to the same signal line. The signal line can also be connected by adopting the method described below (multiple connectors).

WIRED CONTROL

The specifications for the connection between the wired remote control and the indoor units (XY connection) are 0.5 mm² x 2 wires. The maximum permitted length is 600 m. If the length exceeds 100 m, refer to the table.

Length (m)	Type of cables
100~200	0.5 mm ² x 2 wires
~300	0.75 mm ² x 2 wires
~400	1.50 mm ² x 2 wires
~600	2.0 mm ² x 2 wires



It is not allowed to form a loop with signal lines, therefore the section of the connection indicated with ----- is not permitted.

OPERATING MODE

Fixed cooling mode/fixed heating mode (summer/winter switch)

It is possible to fix the operation mode of the system (cooling or heating) using a switch (SW3-7) on the outdoor unit PC board: this enables the user to decide the operation of the system inside the building (e.g. cooling only in summer/heating only in winter). It is also possible to wire the control switch to a remote location (inside the building), in a control room, or even linked to an ambient thermostat.

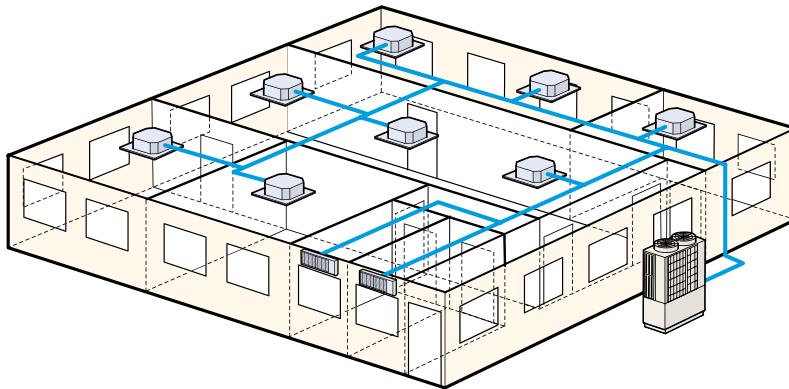

Priority operating mode selection

You can select the following priority operation modes (for the whole system).

1. The first unit's operating mode commands the operating mode (default setting).
2. The last unit's operating mode determines the operating mode for whole system.
3. "Majority" operating mode.
4. "Master" operating mode.

"MAJORITY" OPERATING MODE

The system operates according to the mode selected by the majority of units in operation, taking into consideration the greater capacity between the sum of units in cooling mode and those in heating mode. The minority operating mode is set to fan mode automatically.

"MASTER" OPERATING MODE

In "Master" function, if you select the cooling mode, the units set in heating mode switch to fan mode automatically.

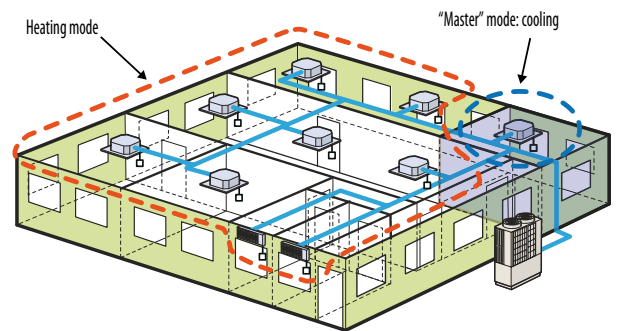
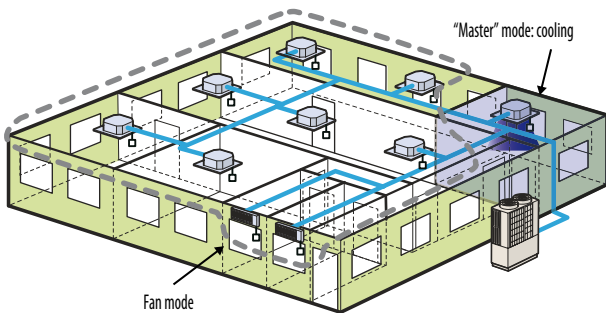

KXZ MICRO VRF-T SYSTEM

Suitable for small or medium-sized offices and shops as well as for residential use

Energy saving, environmental and acoustic comfort as well as installation flexibility make MHI's Micro VRF systems the compact solution for air conditioning of medium and small-sized companies, but also commercial and residential buildings.



BLUE
FIN



KXZ
MICRO
COMPACT

4-6HP
(12.1~15.5 kW)

BLUE
FIN



KXZM
MICRO LARGE
CONNECTION

8~12HP
(22.4~33.5 kW)

BLUE
FIN



KXZ
MICRO
SMART

8~10HP
(22.4~28.0 kW)

MICRO COMPACT

CONNECT UP TO 10 INDOOR UNITS/150% CAPACITY

- FDC 121 KXZEN1/ZES1 12.1 kW 1-Phase/3-Phase
- FDC 140 KXZEN1/ZES1 14.0 kW 1-Phase/3-Phase
- FDC 155 KXZEN1/ZES1 15.5 kW 1-Phase/3-Phase

FEATURES

- Maximum energy efficiency COP 3.92 (4HP)
- Rotary DC Inverter compressor on all units
- DC Inverter fan motors
- 4 sound levels in Silent mode
- New PCB cooling system: a refrigerant pipe branch passes to the base of the PCB to prevent overheating

- **Can connect 1.5 kW indoor units**
- New system for managing indoor unit priorities
- "Pump down" safety function: to identify any gas leaks inside the room (third-party sensor) and start up the refrigerant recall procedure by the outdoor unit, present inside the system

INSTALLATION DIAGRAM

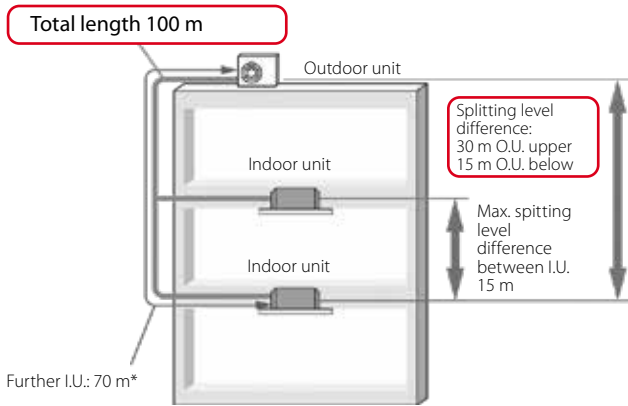

* The total length of piping, liquid side $\varnothing 9.52$ mm (3/8") should be 50 m or less.

OPERATING RANGE

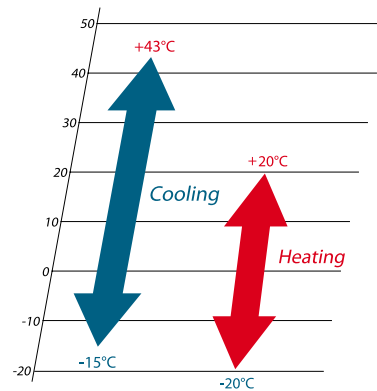

INCREASED NB.. OF CONNECTABLE I.U.

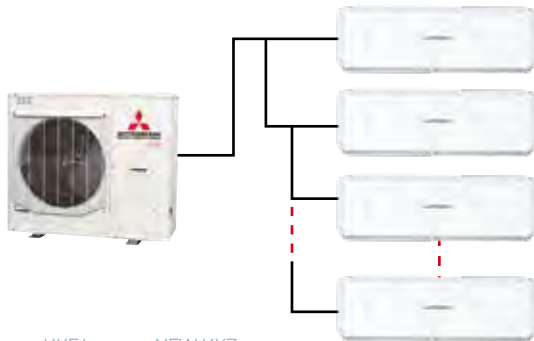

	KXE6	NEW KXZ
4HP	6 units	→ 8 units
5HP	8 units	→ 10 units ¹
6HP	8 units	→ 10 units ²

- 1: max capacity $\leq 100\%$ with 9 or 10 connected units
- 2: max capacity $\leq 100\%$ with 9 or 10 connected units

HIGH EFFICIENCY OF OUTDOOR UNITS 4~6HP

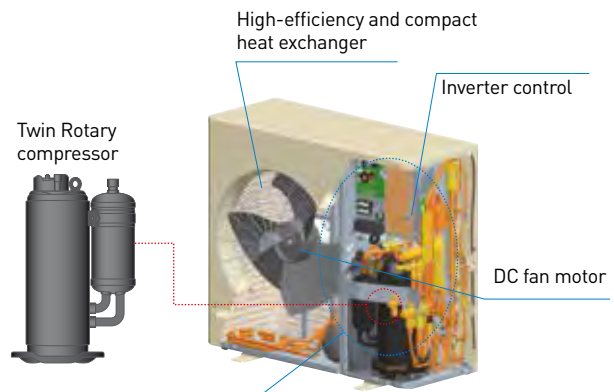

Optimal refrigerant control system, advanced liquid return control, high-speed control system with Superlink, and optimised refrigerant distribution

MICRO COMPACT

4-6HP (12.1~15.5 kW)



REFRIGERANT CONNECTIONS

HP		4	5	6
Liquid side	Furthest I.U. =<70 m	ø 9.52 (3/8")		
Gas side		ø 15.88 (5/8")		

BRANCH PIPES



DIS-22-1B
DIS-180-1B

MANIFOLDS



HEAD4-22-1B
HEAD6-180-1B

Outdoor unit model			FDC 121 KXZEN1	FDC 140 KXZEN1	FDC 155 KXZEN1	FDC 121 KXZES1	FDC 140 KXZES1	FDC 155 KXZES1
Power class	HP		4	5	6	4	5	6
Nominal data								
Rated capacity	Cooling	kW	12.10	14.00	15.50	12.10	14.00	15.50
Rated power input		kW	3.16	3.96	5.20	3.16	3.96	5.20
Rated energy efficiency coefficient		EER ¹	3.83	3.54	2.98	3.83	3.54	2.98
Rated capacity	Heating	kW	12.10	14.00	15.50	12.10	14.00	15.50
Rated power input		kW	3.09	3.66	4.28	3.09	3.66	4.28
Rated energy performance coefficient		COP ¹	3.92	3.83	3.62	3.92	3.83	3.62
Seasonal data								
Seasonal energy efficiency index	Cooling	SEER ²	8.15	7.73	7.21	8.15	7.73	7.21
	Heating	SCOP ²	4.63	4.59	4.55	4.63	4.59	4.55
Electrical data								
Power supply	Ph-V-Hz		1Ph-220~240V-50Hz			3Ph-380~415V-50Hz		
Rated current	Cooling	A	15.30	19.60	25.70	5.20	6.50	8.60
	Heating	A	15.20	18.30	21.40	5.10	6.10	7.10
Maximum current	A	28.00	28.00	28.00	13.50	13.50	13.50	
Refrigerant circuit data								
Refrigerant ³	type (GWP)		R410A (2088)					
Q.ty of refrigerant pre-charge (tons of CO2 equivalent)	kg		5 (10.44)	5 (10.44)	5 (10.44)	5 (10.44)	5 (10.44)	5 (10.44)
Piping diameter	Liquid	inch (mm)	3/8" (9.52)	3/8" (9.52)	3/8" (9.52)	3/8" (9.52)	3/8" (9.52)	3/8" (9.52)
	Gas	inch (mm)	5/8" (15.88)	5/8" (15.88)	5/8" (15.88)	5/8" (15.88)	5/8" (15.88)	5/8" (15.88)
Product specifications								
Dimensions	HxLxD	mm	845x970x370	845x970x370	845x970x370	845x970x370	845x970x370	845x970x370
Net weight	kg		85	85	85	87	87	87
Sound power level	Max	dB(A)	72	72	74	72	72	74
Sound pressure level	Max	dB(A)	56	57	57	56	57	57
Volume of air treated	Standard	m ³ /h	4500	4500	4500	4500	4500	4500
Fan static pressure	Max	Pa	-	-	-	-	-	-
Operating range (outdoor temperature)	Cooling	°C	-15~43	-15~43	-15~43	-15~43	-15~43	-15~43
	Heating	°C	-20~20	-20~20	-20~20	-20~20	-20~20	-20~20
Connectable indoor units	Min ~ Max	nb.	1 ~ 8	1 ~ 10 ⁴	1 ~ 10 ⁴	1 ~ 8	1 ~ 10 ⁴	1 ~ 10 ⁴
	Capacity	%	80 ~ 150	80 ~ 150	80 ~ 150	80 ~ 150	80 ~ 150	80 ~ 150

1. Value measured according to the harmonised standard EN14511. 2. EU Regulations No. 206/2012 - No. 2281/2016 - Value measured according to the harmonised standard EN14825. 3. Refrigerant leakage contributes to climate change. When released into the atmosphere, refrigerants with a lower global warming potential (GWP) contribute less to global warming than those with a higher GWP. This appliance contains a refrigerant with a GWP of 2088. If 1 kg of this refrigerant fluid were released into the atmosphere, therefore, the impact on global warming would be 2088 times higher than 1 kg of CO₂, over a period of 100 years. Under no circumstances should the user try to intervene on the refrigerant circuit or disassemble the product. Always contact qualified personnel if necessary. 4. With limitations on maximum connectivity.

MICRO LARGE CONNECTION

CONNECT UP TO 24 INDOOR UNITS / 150% CAPACITY

FDC 224 KXZME1 22,4 kW 3-Phase

FDC 280 KXZME1 28,0 kW 3-Phase

FDC 335 KXZME1A 33,5 kW 3-Phase

FEATURES

- 1 DC Inverter compressor (8~12HP)
- High splitting distance: up to 510 m in total and with a max. distance between the O.U. and the furthest I.U. of 160 m

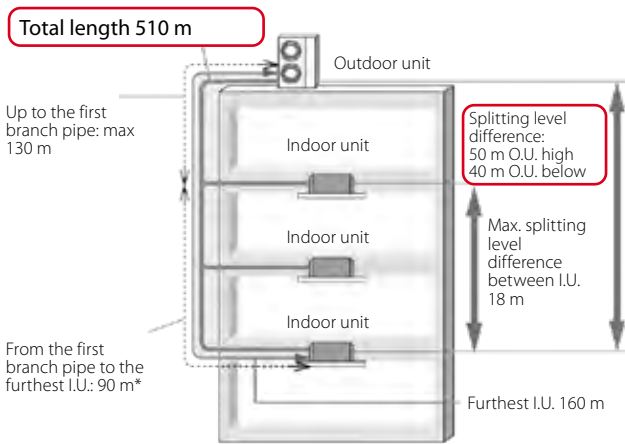

* With length difference between the furthest indoor unit and the nearest one from the first branch pipe < 40 m.

OPERATING RANGE

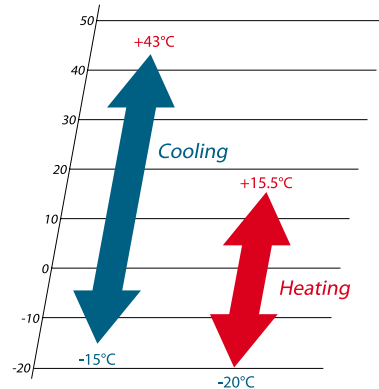

VRF-T TECHNOLOGY

With VRF-T technology, refrigerant temperature control during the condensation and evaporation phases in the refrigerant system ensures energy savings up to 34% in cooling mode during the partial loads, compared to the traditional VRF models.

Traditional system cooling operation

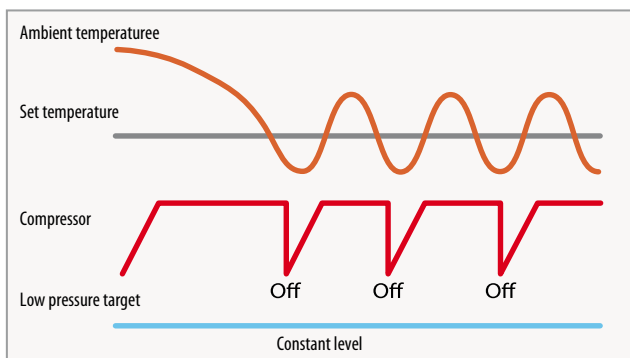

In a traditional system, the refrigerant target pressure to be maintained is constant. As soon as room temperature reaches the temperature set by the user, the compressor is forced to decrease and increase the rpm by on-off cycles that affect the overall efficiency and performance.

KXZ system cooling operation with activation of VRF-T mode

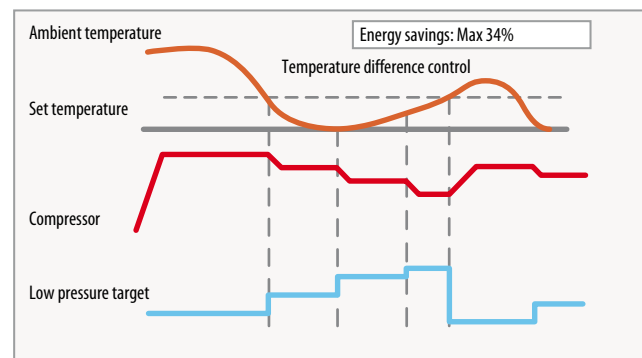

With the new VRF-T, the refrigerant target pressure to be maintained is not constant, but adjusts proportionally to the difference between the room temperature and the desired temperature. This allows the Inverter compressors to modulate the rpm without ever stopping, thus expressing the maximum efficiency for a global energy saving operation.

MICRO LARGE CONNECTION

8~12HP (22.4~33.5 kW)



REFRIGERANT CONNECTIONS

HP		8	10	12
Liquid side	Furthest I.U.	ø9.52		ø12.7
Gas side	=<90 m	ø19.05	ø22.22	ø25.4
Liquid side	Furthest I.U.	ø12.7		
Gas side	=>90 m	ø22.22	ø25.4	

BRANCH PIPES



DIS-22-1B
DIS-180-1B



DIS-371-1B

MANIFOLDS



HEAD4-22-1B
HEAD6-180-1B
HEAD8-371-2B

Outdoor unit model			FDC 224 KXZME1	FDC 280 KXZME1	FDC 335 KXZME1A
Power class	HP		8	10	12
Nominal data					
Rated capacity	Cooling	kW	22.40	28.00	33.50
Rated power input		kW	5.59	7.90	10.68
Rated energy efficiency coefficient		EER ¹	4.01	3.54	3.14
Rated capacity	Heating	kW	22.40	28.00	33.50
Rated power input		kW	4.97	6.53	8.44
Rated energy performance coefficient		COP ¹	4.51	4.29	3.97
Seasonal data					
Seasonal energy efficiency index	Cooling	SEER ²	6.55	6.03	5.84
	Heating	SCOP ²	4.55	4.54	4.04
Electrical data					
Power supply	Ph-V-Hz		3Ph-380~415V-50Hz		
Rated current	Cooling	A	9.40	12.80	17.80
	Heating	A	7.80	10.50	14.40
Maximum current	A		20.00	20.00	23.00
Refrigerant circuit data					
Refrigerant ³	type (GWP)		R410A (2088)		
Q.ty of refrigerant pre-charge ⁴ (tons of CO ₂ equivalent)	kg		11.5 (24.012)	11.5 (24.012)	11.5 (24.012)
Piping diameter	Liquid	inch (mm)	3/8" (9.52)	3/8" (9.52)	1/2" (12.7)
	Gas		3/4" (19.05)	7/8" (22.22)	1" (25.4)
Product specifications					
Dimensions	HxLxD	mm	1675x1080x480	1675x1080x480	1675x1080x480
Net weight	kg		221	221	224
Sound power level	Max	dB(A)	75	76	77
Sound pressure level	Max	dB(A)	59	60	62
Volume of air treated	Standard	m ³ /h	12000	12000	12000
Fan static pressure	Max	Pa	35	35	35
Operating range (outdoor temperature)	Cooling	°C	-15~43	-15~43	-15~43
	Heating	°C	-20~15.5	-20~15.5	-20~15.5
Connectable indoor units ⁵	Min ~ Max	nb.	1 ~ 22	1 ~ 24	1 ~ 24
	Capacity	%	50 ~ 150	50 ~ 150	50 ~ 150

1. Value measured according to the harmonised standard EN14511. 2. EU Regulations No. 206/2012 - No. 2281/2016 - Value measured according to the harmonised standard EN14825. 3. Refrigerant leakage contributes to climate change. When released into the atmosphere, refrigerants with a lower global warming potential (GWP) contribute less to global warming than those with a higher GWP. This appliance contains a refrigerant with a GWP of 2088. If 1 kg of this refrigerant fluid were released into the atmosphere, therefore, the impact on global warming would be 2088 times higher than 1 kg of CO₂, over a period of 100 years. Under no circumstances should the user try to intervene on the refrigerant circuit or disassemble the product. Always contact qualified personnel if necessary. 4. For the calculation of the additional refrigerant charge, refer to the labels placed inside and outside the unit. 5. When connecting indoor units of type FDK, FDL, FDU or FDFW the upper limit is always 130%.

MICRO SMART

CONNECT UP TO 8 INDOOR UNITS/120% CAPACITY

FDC 224 KXZPE1
22.4 kW 3-Phase
FDC 280 KXZPE1
28.0 kW 3-Phase

FEATURES

- Maximum energy efficiency: COP 4.67 (8HP)
- High splitting distance: up to 150 m in total and with a max. distance between the O.U. and the furthest I.U. of 120 m
- Only DC Inverter compressors
- Compressor speed control

OPERATING RANGE

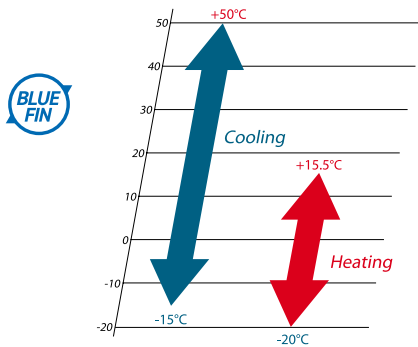

INSTALLATION DIAGRAM

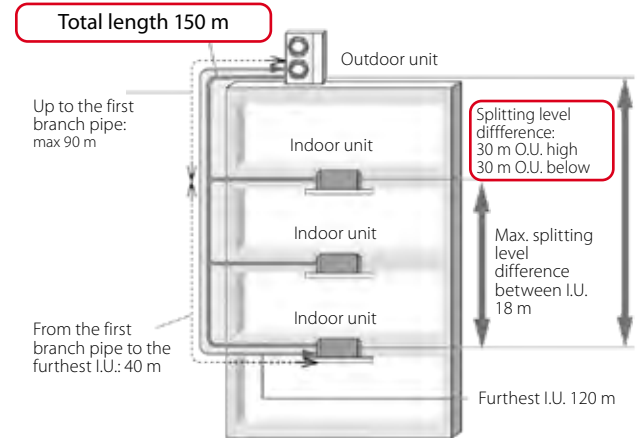

8~10HP (22.4~28.0 kW)

REFRIGERANT CONNECTIONS

HP		8	10
Liquid side	Furthest I.U. =<90 m	ø9.52	
	Gas side	ø19.05	ø22.22
Liquid side	Furthest I.U. =>90 m	ø 12.7	
	Gas side	ø22.22	ø25.4/ø28.58

BRANCH PIPES

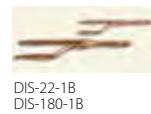

MANIFOLDS



Outdoor unit model			FDC 224 KXZPE1	FDC 280 KXZPE1
Power class	HP		8	10
Nominal data				
Rated capacity	Cooling	kW	22.40	28.00
Rated power input		kW	5.60	7.87
Rated energy efficiency coefficient		EER ¹	4.00	3.56
Rated capacity	Heating	kW	22.40	28.00
Rated power input		kW	4.80	6.47
Rated energy performance coefficient		COP ¹	4.67	4.33
Seasonal data				
Seasonal energy efficiency index	Cooling	SEER ²	6.65	6.68
	Heating	SCOP ²	4.34	4.50
Electrical data				
Power supply	Ph-V-Hz		3Ph-380~415V-50Hz	
Rated current	Cooling	A	9.20	12.90
	Heating	A	7.90	10.50
Maximum current	A		21.00	22.00
Refrigerant circuit data				
Refrigerant ³	type (GWP)		R410A (2088)	
Q.ty of refrigerant pre-charge (tons of CO ₂ equivalent)	kg		8.9 (18.583)	8.9 (18.583)
Piping diameter	Liquid	inch (mm)	3/8" (9.52)	3/8" (9.52)
	Gas		3/4" (19.05)	7/8" (22.22)
Product specifications				
Dimensions	HxLxD	mm	1505x970x370	
Net weight		kg	165	
Sound power level	Max	dB(A)	73	
Sound pressure level	Max	dB(A)	60	
Volume of air treated	Standard	m ³ /h	7800	
Fan static pressure	Max	Pa	35	
Operating range (outdoor temperature)	Cooling	°C	-15~50	
	Heating	°C	-20~15.5	
Connectable indoor units	Min ~ Max	nb.	1 ~ 8	
	Capacity	%	50 ~ 120	

1. Value measured according to the harmonised standard EN14511. 2. EU Regulations No. 206/2012 - No. 2281/2016 - Value measured according to the harmonised standard EN14825. 3. Refrigerant leakage contributes to climate change. When released into the atmosphere, refrigerants with a lower global warming potential (GWP) contribute less to global warming than those with a higher GWP. This appliance contains a refrigerant with a GWP of 2088. If 1 kg of this refrigerant fluid were released into the atmosphere, therefore, the impact on global warming would be 2088 times higher than 1 kg of CO₂, over a period of 100 years. Under no circumstances should the user try to intervene on the refrigerant circuit or disassemble the product. Always contact qualified personnel if necessary.

KXZ2 VRF-T SYSTEM

The best solution for air conditioning "sophisticated" buildings

High air conditioning performance for all commercial applications.
Comfort and energy efficiency, application flexibility, intuitive and customizable controls, maintenance and management made even easier.



10~12HP
(28.0~33.5 kW)



14~20HP
(40.0~56.0 kW)

KXZ2

CONNECT UP TO 44 INDOOR UNITS/
200% CAPACITY

FDC 280 KXZE2 28.0 kW

FDC 335 KXZE2 33.5 kW

FEATURES

- Maximum energy efficiency: COP 4.25 and EER 3.86 [10 HP]
- Only DC Inverter compressors
- High splitting distance: up to 1000 m in total and with a max. distance between the O.U. and the furthest I.U. of 160 m
- Up to 85 Pa fan static pressure

OPERATING RANGE

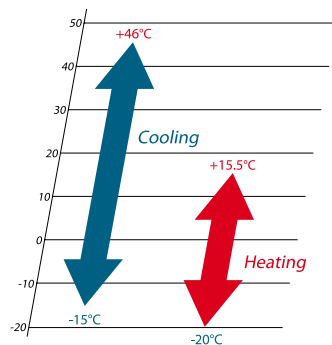

10~12HP (28.0~33.5 kW)

INSTALLATION DIAGRAM

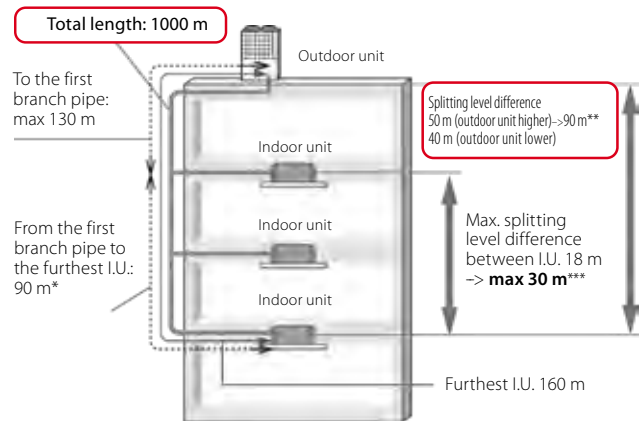

* With difference of length between the furthest indoor unit and the nearest one from the first branch pipe < 40 m (MAX 85 m).
** Comply with installation conditions. For details, refer to the Technical Manual.
*** It is necessary to change the corresponding setting of each difference in level during installation. Range of use also varies.

Outdoor unit model			FDC 280 KXZE2	FDC 335 KXZE2
Power class	HP		10	12
Nominal data				
Rated capacity	Cooling	kW	28.00	33.50
Rated power input		kW	7.25	8.98
Rated energy efficiency coefficient		EER ¹	3.86	3.73
Rated capacity	Heating	kW	31.50	37.5
Rated power input		kW	7.41	9.03
Rated energy performance coefficient		COP ¹	4.25	4.15
Seasonal data				
Seasonal energy efficiency index	Cooling	SEER ²	7.30	7.54
	Heating	SCOP ²	4.88	4.68
Electrical data				
Power supply	Ph-V-Hz		3Ph-380~415V-50Hz	
Rated current	Cooling	A	120	14.7
	Heating	A	12.20	14.80
Maximum current	A		20.10	20.10
Refrigerant circuit data				
Refrigerant ³	type (GWP)		R410A (2088)	
Q.ty of refrigerant pre-charge ⁴ (tons of CO ₂ equivalent)	kg		11 (22.968)	11 (22.968)
Piping diameter	Liquid	inch (mm)	3/8" (9.52)	1/2" (12.7)
	Gas		7/8" (22.22)	1" (25.4)
Product specifications				
Dimensions	HxLxD	mm	1697x1350x720	1697x1350x720
Net weight		kg	288	288
Sound power level	Max	dB(A)	76	82
Sound pressure level	Max	dB(A)	57	63
Volume of air treated	Standard	m ³ /h	13500	17640
Fan static pressure	Max	Pa	85	85
Operating range (outdoor temperature)	Cooling	°C	-15~46	-15~46
	Heating	°C	-20~15.5	-20~15.5
Connectable indoor units ⁵	Min ~ Max	nb.	1 ~ 37	1 ~ 44
	Capacity	%	50 ~ 200	50 ~ 200

1. Value measured according to the harmonised standard EN14511. 2. EU Regulations No. 206/2012 - No. 2281/2016 - Value measured according to the harmonised standard EN14825. 3. Refrigerant leakage contributes to climate change. When released into the atmosphere, refrigerants with a lower global warming potential (GWP) contribute less to global warming than those with a higher GWP. This appliance contains a refrigerant with a GWP of 2088. If 1 kg of this refrigerant fluid were released into the atmosphere, therefore, the impact on global warming would be 2088 times higher than 1 kg of CO₂ over a period of 100 years. Under no circumstances should the user try to intervene on the refrigerant circuit or disassemble the product. Always contact qualified personnel if necessary. 4. For the calculation of the additional refrigerant charge, refer to the labels placed inside and outside the unit. 5. When connecting indoor units of type FDK, FDL, FDFU or FDFW the upper limit is always 130%.

KXZ2

CONNECT UP TO 59 INDOOR UNITS/
160% (FDC 400~450 KXZE2 200%) CAPACITY

- FDC 400 KXZE2 40.0 kW FDC 500 KXZE2 50.0 kW
- FDC 450 KXZE2 45.0 kW FDC 560 KXZE2 56.0 kW
- FDC 475 KXZE2 47.5 kW

CARATTERISTICHE

- Maximum energy efficiency: COP 4.40 and EER 3.64 [14 HP]
- Only DC Inverter compressors
- High splitting distance: up to 1000 m in total and with a max. distance between the O.U. and the furthest I.U. of 160 m
- Up to 85 Pa fan static pressure



OPERATING RANGE

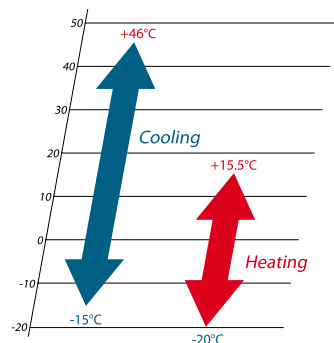

INSTALLATION DIAGRAM

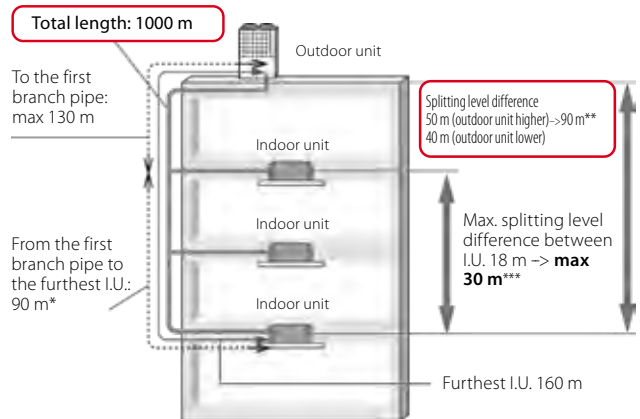

14~20HP (40.0~56.0 kW)

* With difference of length between the furthest indoor unit and the nearest one from the first branch pipe < 40 m (MAX 85 m).
 ** Comply with installation conditions. For details, refer to the Technical Manual.
 *** It is necessary to change the corresponding setting of each difference in level during installation. Range of use also varies.

Outdoor unit model			FDC 400 KXZE2	FDC 450 KXZE2	FDC 475 KXZE2	FDC 500 KXZE2	FDC 560 KXZE2
Power class		HP	14	16	17	18	20
Nominal data							
Rated capacity	Cooling	kW	40.00	45.00	47.50	50.00	56.00
Rated power input		kW	10.98	13.98	13.97	14.01	17.50
Rated energy efficiency coefficient		EER ¹	3.64	3.22	3.40	3.57	3.20
Rated capacity	Heating	kW	45.00	50.00	53.00	56.00	63.00
Rated power input		kW	10.23	12.50	12.99	13.56	16.15
Rated energy performance coefficient		COP ¹	4.40	4.00	4.08	4.13	3.90
Seasonal data							
Seasonal energy efficiency index	Cooling	SEER ²	7.12	7.01	6.84	7.29	6.73
	Heating	SCOP ²	4.87	4.36	4.45	4.58	4.30
Electrical data							
Power supply		Ph-V-Hz	3Ph-380~415V-50Hz				
Rated current	Cooling	A	17.60	22.40	22.60	22.60	26.90
	Heating	A	16.70	20.40	21.00	21.90	26.10
Maximum current		A	32.00	32.00	40.20	40.20	40.20
Refrigerant circuit data							
Refrigerant ³		type (GWP)	R410A (2088)				
Q.ty of refrigerant pre-charge ⁴ (tons of CO ₂ equivalent)		kg	11.5 (24.012)	11.5 (24.012)	11.5 (24.012)	11.5 (24.012)	11.5 (24.012)
Piping diameter	Liquid	inch (mm)	1/2" (12.7)	1/2" (12.7)	1/2" (12.7)	1/2" (12.7)	1/2" (12.7)
	Gas	inch (mm)	1" (25.4)	1-1/8" (28.58)	1-1/8" (28.58)	1-1/8" (28.58)	1-1/8" (28.58)
Product specifications							
Dimensions	HxLxD	mm	2052x1350x720	2052x1350x720	2052x1350x720	2052x1350x720	2052x1350x720
Net weight		kg	332	332	378	378	378
Sound power level	Max	dB(A)	82	82	81	82	83
Sound pressure level	Max	dB(A)	62	62	61	62	64
Volume of air treated	Standard	m ³ /h	18240	18240	18000	18000	18000
Fan static pressure	Max	Pa	85	85	85	85	85
Operating range (outdoor temperature)	Cooling	°C	-15~-46	-15~-46	-15~-46	-15~-46	-15~-46
	Heating	°C	-20~-15.5	-20~-15.5	-20~-15.5	-20~-15.5	-20~-15.5
Connectable indoor units ⁵	Min ~ Max	nb.	1 ~ 53	1 ~ 60	1 ~ 50	1 ~ 53	1 ~ 59
	Capacity	%	50 ~ 200	50 ~ 200	50 ~ 160	50 ~ 160	50 ~ 160

1. Value measured according to the harmonised standard EN14511. 2. EU Regulations No. 206/2012 - No. 2281/2016 - Value measured according to the harmonised standard EN14825. 3. Refrigerant leakage contributes to climate change. When released into the atmosphere, refrigerants with a lower global warming potential (GWP) contribute less to global warming than those with a higher GWP. This appliance contains a refrigerant with a GWP of 2088. If 1 kg of this refrigerant fluid were released into the atmosphere, therefore, the impact on global warming would be 2088 times higher than 1 kg of CO₂ over a period of 100 years. Under no circumstances should the user try to intervene on the refrigerant circuit or disassemble the product. Always contact qualified personnel if necessary. 4. For the calculation of the additional refrigerant charge, refer to the labels placed inside and outside the unit. 5. When connecting indoor units of type FDK, FDL, FDFU or FDFW the upper limit is always 130%.

KXZ2

CONNECT UP TO 71 INDOOR UNITS/160% CAPACITY

FDC 615 KXZE2 (FDC 280+FDC 335) 61.5 kW

FDC 670 KXZE2 (FDC 335+FDC 335) 67.0 kW

FEATURES

- Maximum energy efficiency: COP 4.20 and EER 3.79 [22 HP]
- Only DC Inverter compressors
- High splitting distance: up to 1000 m in total and with a max. distance between the O.U. and the furthest I.U. of 160 m
- Up to 85 Pa fan static pressure

OPERATING RANGE

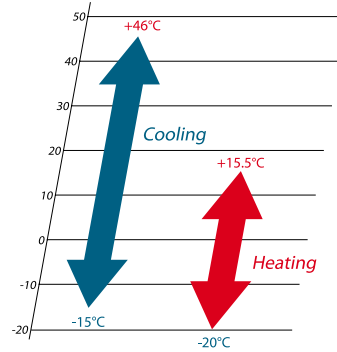

22~24HP
(61.5~67.0 kW)

COMBINATIONS

Outdoor unit model			FDC 615 KXZE2	FDC 670 KXZE2
Combinations			FDC 280 KXZE2	FDC 335 KXZE2
			FDC 335 KXZE2	FDC 335 KXZE2
Power class			22	24
Rated capacity	Cooling	HP	22	24
Rated power input		kW	61.50	67.00
Rated energy efficiency coefficient		EER1	16.24	17.96
Rated capacity	Heating	kW	69.00	75.00
Rated power input		kW	16.44	18.06
Rated energy performance coefficient		COP1	4.20	4.15
Electrical data			3Ph-380~415V-50Hz	
Power supply		Ph-V-Hz		
Rated current	Cooling	A	26.70	29.40
	Heating	A	27.00	29.60
Maximum current		A	40.20	40.20
Refrigerant circuit data			R410A (2088)	
Refrigerant ²		type (GWP)		
Q.ty of refrigerant pre-charge ³ (tons of CO2 equivalent)		kg	22 (45.936)	22 (45.936)
Piping diameter ⁴	Liquid	inch (mm)	1/2" (12.7)	1/2" (12.7)
	Gas	inch (mm)	1-1/8" (28.58)	1-1/8" (28.58)
	Oil balancing	inch (mm)	3/8" (9.52)	3/8" (9.52)
Product specifications				
Dimensions	HxLxD	mm	1697x2700x720	1697x2700x720
Net weight		kg	576	576
Connectable indoor units ⁵	Min ~ Max	nb.	2 ~ 65	2 ~ 71
	Capacity	%	50 ~ 160	50 ~ 160

1. Value measured according to the harmonised standard EN 14511. 2. Refrigerant leakage contributes to climate change. When released into the atmosphere, refrigerants with a lower global warming potential (GWP) contribute less to global warming than those with a higher GWP. This appliance contains a refrigerant with a GWP of 2088. If 1 kg of this refrigerant fluid were released into the atmosphere, therefore, the impact on global warming would be 2088 times higher than 1 kg of CO₂, over a period of 100 years. Under no circumstances should the user try to intervene on the refrigerant circuit or disassemble the product. Always contact qualified personnel if necessary. 3. For the calculation of the additional refrigerant charge, refer to the labels positioned inside and outside the unit. 4. The diameters indicated refer to the section up to the first junction, with an equivalent length of less than 90 m. 5. When connecting indoor units of type FDK, FDFL, FDFU or FDFW the upper limit is always 130%.

KXZ2

CONNECT UP TO 80 INDOOR UNITS/160% CAPACITY
(FDC 1000~1120 KXZE2 130%)

FDC 735 KXZE2 (FDC 335+FDC 400) 73.5 kW
 FDC 800 KXZE2 (FDC 400+FDC 400) 80.0 kW
 FDC 850 KXZE2 (FDC 400+FDC 450) 85.0 kW
 FDC 900 KXZE2 (FDC 450+FDC 450) 90.0 kW

FDC 950 KXZE2 (FDC 475+FDC 475) 95.0 kW
 FDC 1000 KXZE2 (FDC 500+FDC 500) 100.0 kW
 FDC 1060 KXZE2 (FDC 500+FDC 560) 106.0 kW
 FDC 1120 KXZE2 (FDC 560+FDC 560) 112.0 kW

FEATURES

- Maximum energy efficiency: COP 4.40 (28HP); EER 3.68 [26 HP]
- Only DC Inverter compressors
- High splitting distance: up to 1000 m in total and with a max. distance between the O.U. and the furthest I.U. of 160 m
- Up to 85 Pa fan static pressure

OPERATING RANGE

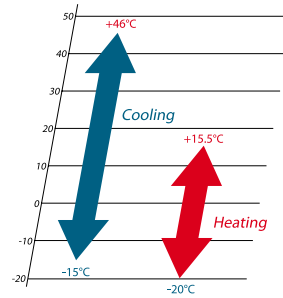

26HP (73,5 kW)



28~40HP (80,0~112,0 kW)

COMBINATIONS

Outdoor unit model			FDC 735 KXZE2	FDC 800 KXZE2	FDC 850 KXZE2	FDC 900 KXZE2	FDC 950 KXZE2	FDC 1000 KXZE2	FDC 1060 KXZE2	FDC 1120 KXZE2
Combinations			FDC 335 KXZE2	FDC 400 KXZE2	FDC 400KXZE2	FDC 450 KXZE2	FDC 475 KXZE2	FDC 500 KXZE2	FDC 500 KXZE2	FDC 560 KXZE2
Power class			HP	26	28	30	32	34	36	38
Rated capacity	Cooling	kW	73.50	80.00	85.00	90.00	95.00	100.00	106.00	112.00
		kW	19.96	21.96	24.96	27.95	27.94	28.02	31.51	35.00
Rated energy efficiency coefficient		EER1	3.68	3.64	3.41	3.22	3.40	3.57	3.36	3.20
Rated capacity	Heating	kW	82.50	90.00	95.00	100.00	106.00	112.00	119.00	126.00
		kW	19.26	20.45	22.73	25	25.98	27.12	29.71	32.31
Rated energy performance coefficient		COP1	4.28	4.40	4.18	4.00	4.08	4.13	4.01	3.90
Electrical data										
Power supply		Ph-V-Hz	3Ph-380~415V-50Hz							
Rated current	Cooling	A	32.30	35.20	40.00	44.80	45.20	45.20	49.50	53.80
	Heating	A	31.50	33.40	37.10	40.80	42.00	43.80	48.00	52.20
Maximum current		A	52.10	64.00	64.00	64.00	80.40	80.40	80.40	80.40
Refrigerant circuit data										
Refrigerant ²		type (GWP)	R410A (2088)							
Q.ty of refrigerant pre-charge ³ (tons of CO2 equivalent)		kg	22.5 (46.980)	23 (48.024)	23 (48.024)	23 (48.024)	23 (48.024)	23 (48.024)	23 (48.024)	23 (48.024)
Piping diameter ⁴	Liquid	inch (mm)	5/8" (15.88)	5/8" (15.88)	5/8" (15.88)	5/8" (15.88)	5/8" (15.88)	5/8" (15.88)	3/4" (19.05)	3/4" (19.05)
	Gas	inch (mm)	1-1/4" (31.75)	1-1/4" (31.75)	1-1/4" (31.75)	1-1/4" (31.75)	1-1/4" (31.75)	1-1/2" (38.1)	1-1/2" (38.1)	1-1/2" (38.1)
	Oil balancing	inch (mm)	3/8" (9.52)	3/8" (9.52)	3/8" (9.52)	3/8" (9.52)	3/8" (9.52)	3/8" (9.52)	3/8" (9.52)	3/8" (9.52)
Product specifications										
Dimensions		HxLxD	mm	2052x2700x720	2052x2700x720	2052x2700x720	2052x2700x720	2052x2700x720	2052x2700x720	2052x2700x720
Net weight		kg	620	664	664	664	756	756	756	756
Connectable indoor units ⁵	Min ~ Max	nb.	2 ~ 78	2 ~ 80	2 ~ 80	2 ~ 80	2 ~ 80	2 ~ 80	2 ~ 80	2 ~ 80
	Capacity	%	50 ~ 160	50 ~ 160	50 ~ 160	50 ~ 160	50 ~ 160	50 ~ 130	50 ~ 130	50 ~ 130

1. Value measured according to the harmonised standard EN 14511. 2. Refrigerant leakage contributes to climate change. When released into the atmosphere, refrigerants with a lower global warming potential (GWP) contribute less to global warming than those with a higher GWP. This appliance contains a refrigerant with a GWP of 2088. If 1 kg of this refrigerant fluid were released into the atmosphere, therefore, the impact on global warming would be 2088 times higher than 1 kg of CO₂, over a period of 100 years. Under no circumstances should the user try to intervene on the refrigerant circuit or disassemble the product. Always contact qualified personnel if necessary. 3. For the calculation of the additional refrigerant charge, refer to the labels positioned inside and outside the unit. 4. The diameters indicated refer to the section up to the first junction, with an equivalent length of less than 90 m. 5. When connecting indoor units of type FDK, FDFL, FDFU or FDFW the upper limit is always 130%.

KXZ2

CONNECT UP TO 80 INDOOR UNITS/130% CAPACITY

FDC 1200 KXZE2 (FDC 400+FDC 400+FDC 400) 120.0 kW
 FDC 1250 KXZE2 (FDC 400+FDC 400+FDC 450) 125.0 kW
 FDC 1300 KXZE2 (FDC 400+FDC 450+FDC 450) 130.0 kW
 FDC 1350 KXZE2 (FDC 450+FDC 450+FDC 450) 135.0 kW
 FDC 1425 KXZE2 (FDC 475+FDC 475+FDC 475) 142.5 kW

FDC 1450 KXZE2 (FDC 475+FDC 475+FDC 500) 145.0 kW
 FDC 1500 KXZE2 (FDC 500+FDC 500+FDC 500) 150.0 kW
 FDC 1560 KXZE2 (FDC 500+FDC 500+FDC 560) 156.0 kW
 FDC 1620 KXZE2 (FDC 500+FDC 560+FDC 560) 162.0 kW
 FDC 1680 KXZE2 (FDC 560+FDC 560+FDC 560) 168.0 kW

FEATURES

- Maximum energy efficiency: COP 4.40 and EER 3.64 [42 HP]
- Only DC Inverter compressors
- High splitting distance: up to 1000 m in total and with a max. distance between the O.U. and the further I.U. of 160 m
- Up to 85 Pa fan static pressure

OPERATING RANGE

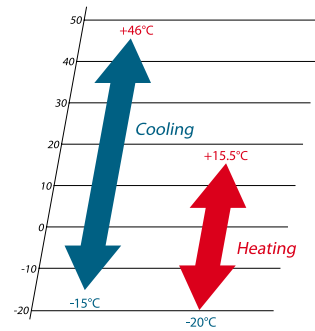

42~60HP
(120.0~168.0 kW)

COMBINATIONS

Outdoor unit model			FDC 1200 KXZE2	FDC 1250 KXZE2	FDC 1300 KXZE2	FDC 1350 KXZE2	FDC 1425 KXZE2	FDC 1450 KXZE2	FDC 1500 KXZE2	FDC 1560 KXZE2	FDC 1620 KXZE2	FDC 1680 KXZE2		
Combinations			FDC 400 KXZE2	FDC 400 KXZE2	FDC 400 KXZE2	FDC 450 KXZE2	FDC 475 KXZE2	FDC 475 KXZE2	FDC 500 KXZE2	FDC 500 KXZE2	FDC 560 KXZE2	FDC 560 KXZE2		
Power class			HP	42	44	46	48	50	52	54	56	60		
Rated capacity			kW	120.00	125.00	130.00	135.00	142.50	145.00	150.00	156.00	162.00	168.00	
Rated power input			kW	32.94	35.94	38.93	41.93	41.91	41.95	42.03	45.52	49.01	52.50	
Rated energy efficiency coefficient			EER ¹	3.64	3.48	3.34	3.22	3.40	3.46	3.57	3.43	3.31	3.20	
Rated capacity			kW	135.00	140.00	145.00	150.00	159.00	162.00	168.00	175.00	182.00	189.00	
Rated power input			kW	30.68	32.95	35.23	37.50	38.97	39.54	40.68	43.27	45.87	48.46	
Rated energy performance coefficient			COP ¹	4.40	4.25	4.12	4.00	4.08	4.10	4.13	4.04	3.97	3.90	
Electrical data														
Power supply			Ph-V-Hz	3Ph-380~415V-50Hz										
Rated current			Cooling	A	52.80	57.60	62.40	67.20	67.80	67.80	72.10	76.40	80.70	
			Heating	A	50.10	53.80	57.50	61.20	63.00	63.90	65.70	69.90	74.10	78.30
Maximum current			A	96.00	96.00	96.00	96.00	120.60	120.60	120.60	120.60	120.60	120.60	
Refrigerant circuit data														
Refrigerant ²			type (GWP)	R410A (2088)										
Q.ty of refrigerant pre-charge ³ (tons of CO ₂ equivalent)			kg	34.5 (72.036)	34.5 (72.036)	34.5 (72.036)	34.5 (72.036)	34.5 (72.036)	34.5 (72.036)	34.5 (72.036)	34.5 (72.036)	34.5 (72.036)		
Piping diameter ⁴			Liquid	3/4" (19.05)	3/4" (19.05)	3/4" (19.05)	3/4" (19.05)	3/4" (19.05)	3/4" (19.05)	3/4" (19.05)	3/4" (19.05)	3/4" (19.05)		
			Gas	1-1/2" (38.1)	1-1/2" (38.1)	1-1/2" (38.1)	1-1/2" (38.1)	1-1/2" (38.1)	1-1/2" (38.1)	1-1/2" (38.1)	1-1/2" (38.1)	1-1/2" (38.1)		
			Oil balancing	3/8" (9.52)	3/8" (9.52)	3/8" (9.52)	3/8" (9.52)	3/8" (9.52)	3/8" (9.52)	3/8" (9.52)	3/8" (9.52)	3/8" (9.52)		
Product specifications														
Dimensions			HxLxD	2052x4050x720										
Net weight			kg	996	996	996	996	1134	1134	1134	1134	1134		
Connectable indoor units ⁵			Min ~ Max	nb.	3 ~ 80	3 ~ 80	3 ~ 80	3 ~ 80	3 ~ 80	3 ~ 80	3 ~ 80	3 ~ 80		
			Capacity	%	50 ~ 130	50 ~ 130	50 ~ 130	50 ~ 130	50 ~ 130	50 ~ 130	50 ~ 130	50 ~ 130		

1. Value measured according to the harmonised standard EN 14511. 2. Refrigerant leakage contributes to climate change. When released into the atmosphere, refrigerants with a lower global warming potential (GWP) contribute less to global warming than those with a higher GWP. This appliance contains a refrigerant with a GWP of 2088. If 1 kg of this refrigerant fluid were released into the atmosphere, therefore, the impact on global warming would be 2088 times higher than 1 kg of CO₂, over a period of 100 years. Under no circumstances should the user try to intervene on the refrigerant circuit or disassemble the product. Always contact qualified personnel if necessary. 3. For the calculation of the additional refrigerant charge, refer to the labels positioned inside and outside the unit. 4. The diameters indicated refer to the section up to the first junction, with an equivalent length of less than 90 m. 5. When connecting indoor units of type FDK, FDFL, FDFU or FDFW the upper limit is always 130%.

KXZX2 Hi-COP VRF-T MODULAR SYSTEM

Record efficiency in heating and cooling

Greater energy efficiency with KXZX2 heat pump systems,
in any combination of outdoor units.



10HP
(28.0 kW)



12~14HP
(33.5~40.0 kW)

KXZX2 Hi-COP

Combinations 20~40HP (56.0~113.5 kW)

CONNECT UP TO 80 INDOOR UNITS/160% (FDC 1000~1120 KXZE2 130%) CAPACITY

FDC 560 KXZX2 (FDC 280+FDC 280)	56.0 kW
FDC 850 KXZX2 (FDC 280+FDC 280+FDC 280)	84.0 kW
FDC 900 KXZX2 (FDC 280+FDC 280+FDC 335)	89.5 kW
FDC 950 KXZX2 (FDC 280+FDC 335+FDC 335)	95.0 kW
FDC 1000 KXZX2 (FDC 335+FDC 335+FDC 335)	100.5 kW
FDC 1060 KXZX2 (FDC 280+FDC 335+FDC 400)	107.0 kW
FDC 1120 KXZX2 (FDC 335+FDC 400+FDC 400)	113.5 kW

Hi-COP FEATURES

- High efficiency
- Reduced consumption
- High energy saving

FEATURES

- Maximum energy efficiency: COP 4.32 (40HP) and EER 3.86 (20HP)
- Only DC Inverter compressors
- High splitting distance: up to 1000 m in total and with a max. distance between the O.U. and the furthest I.U. of 160 m
- Up to 85 Pa fan static pressure

INSTALLATION DIAGRAM

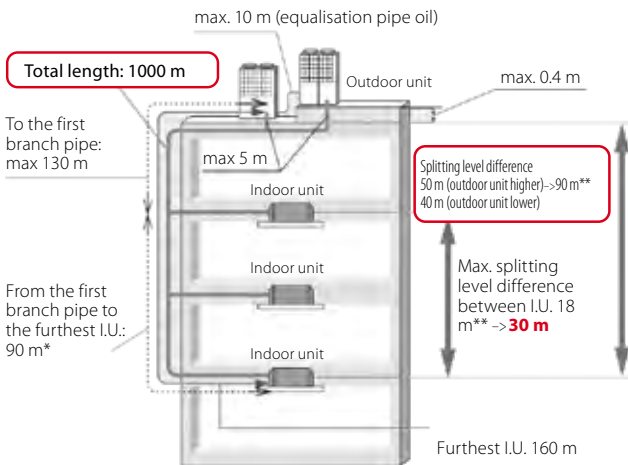

* With difference of length between the farthest indoor unit and the nearest one from the first branch pipe <40 m. (MAX 85 m).

** Comply with installation conditions. For details, refer to the Technical Manual.

OPERATING RANGE

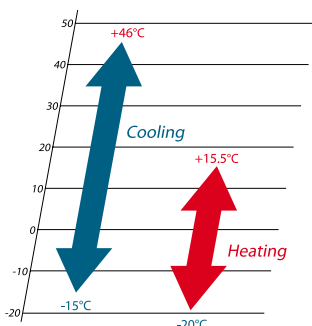

20HP
(56.0 kW)



30~36HP
(84.0~100.5 kW)



38HP
(107.0 kW)



40HP
(113.5 kW)



KXZX2 Hi-COP

COMBINATIONS

Outdoor unit model			FDC 560 KXZE2	FDC 850 KXZE2	FDC 900 KXZE2
Combinations			FDC 280 KXZE2	FDC 280 KXZE2	FDC 280 KXZE2
			FDC 280 KXZE2	FDC 280 KXZE2	FDC 280 KXZE2
			-	FDC 280 KXZE2	FDC 335 KXZE2
Power class	HP	20	30	32	
Rated capacity	Cooling	kW	56.00	84.00	89.50
Rated power input		kW	14.51	21.76	23.49
Rated energy efficiency coefficient		EER ¹	3.86	3.86	3.81
Rated capacity	Heating	kW	63.00	94.50	100.50
Rated power input		kW	14.82	22.23	23.85
Rated energy performance coefficient		COP ¹	4.25	4.25	4.21
Electrical data					
Power supply	Ph-V-Hz	3Ph-380~415V-50Hz			
Rated current	Cooling	A	24.00	36.00	38.70
	Heating	A	24.40	36.60	39.20
Maximum current		A	40.20	60.30	60.30
Refrigerant circuit data					
Refrigerant ²	type (GWP)	R410A (2088)			
Q.ty of refrigerant pre-charge ³ (tons of CO2 equivalent)	kg	22 (45.936)	33 (68.904)	33 (68.904)	33 (68.904)
Piping diameter ⁴	Liquid	inch (mm)	1/2" (12.7)	5/8" (15.88)	5/8" (15.88)
	Gas	inch (mm)	1-1/8" (28.58)	1-1/4" (31.75)	1-1/4" (31.75)
	Oil balancing	inch (mm)	3/8" (9.52)	3/8" (9.52)	3/8" (9.52)
Product specifications					
Dimensions	HxLxD	mm	1697x2700x720	1697x4050x720	1697x4050x720
Net weight		kg	576	864	864
Connectable indoor units ⁵	Min ~ Max	nb.	2 ~ 59	3 ~ 80	3 ~ 80
	Capacity	%	80 ~ 160	80 ~ 160	80 ~ 160

Outdoor unit model			FDC 950 KXZE2	FDC 1000 KXZE2	FDC 1060 KXZE2	FDC 1120 KXZE2
Combinations			FDC 280 KXZE2	FDC 335 KXZE2	FDC 335 KXZE2	FDC 335 KXZE2
			FDC 335 KXZE2	FDC 335 KXZE2	FDC 335 KXZE2	FDC 400 KXZE2
			FDC 335 KXZE2	FDC 335 KXZE2	FDC 400 KXZE2	FDC 400 KXZE2
Power class	HP	34	36	38	40	
Rated capacity	Cooling	kW	95.00	100.50	107.00	113.50
Rated power input		kW	25.22	26.94	28.94	30.94
Rated energy efficiency coefficient		EER ¹	3.77	3.73	3.70	3.67
Rated capacity	Heating	kW	106.50	112.50	120.00	127.50
Rated power input		kW	25.47	27.09	28.29	29.48
Rated energy performance coefficient		COP ¹	4.18	4.15	4.24	4.32
Electrical data						
Power supply	Ph-V-Hz	3Ph-380~415V-50Hz				
Rated current	Cooling	A	41.40	44.10	47.00	49.90
	Heating	A	41.80	44.40	46.30	48.20
Maximum current		A	60.30	60.30	72.20	84.10
Refrigerant circuit data						
Refrigerant ²	type (GWP)	R410A (2088)				
Q.ty of refrigerant pre-charge ³ (tons of CO2 equivalent)	kg	33 (68.904)	33 (68.904)	33.5 (69.948)	34 (70.992)	
Piping diameter ⁴	Liquid	inch (mm)	5/8" (15.88)	5/8" (15.88)	3/4" (19.05)	3/4" (19.05)
	Gas	inch (mm)	1-1/4" (31.75)	1-1/2" (38.1)	1-1/2" (38.1)	1-1/2" (38.1)
	Oil balancing	inch (mm)	3/8" (9.52)	3/8" (9.52)	3/8" (9.52)	3/8" (9.52)
Product specifications						
Dimensions	HxLxD	mm	1697x4050x720	1697x4050x720	2052x4050x720	2052x4050x720
Net weight		kg	864	864	908	952
Connectable indoor units ⁵	Min ~ Max	nb.	3 ~ 80	3 ~ 80	3 ~ 80	3 ~ 80
	Capacity	%	80 ~ 160	80 ~ 130	80 ~ 130	80 ~ 130

1. Value measured according to the harmonised standard EN 14511. 2. Refrigerant leakage contributes to climate change. When released into the atmosphere, refrigerants with a lower global warming potential (GWP) contribute less to global warming than those with a higher GWP. This appliance contains a refrigerant with a GWP of 2088. If 1 kg of this refrigerant fluid were released into the atmosphere, therefore, the impact on global warming would be 2088 times higher than 1 kg of CO₂ over a period of 100 years. Under no circumstances should the user try to intervene on the refrigerant circuit or disassemble the product. Always contact qualified personnel if necessary. 3. For the calculation of the additional refrigerant charge, refer to the labels positioned inside and outside the unit. 4. The diameters indicated refer to the section up to the first junction, with an equivalent length of less than 90 m. 5. When connecting indoor units of type FDK, FDFL, FDFU or FDFW the upper limit is always 130%.

HEAT RECOVERY KXZR2 SYSTEM

The new KXZR2 features a tiered design and a completely new shape. Thanks to the 3-pipe system, a single outdoor unit can simultaneously heat or cool several indoor units.

SIMULTANEOUS HEATING AND COOLING

- Heat recovery.
- An extensive range of applications.
- Flexibility of the design.
- Better low temperature cooling capacity.
- Easy maintenance.

NEW DESIGN AND ENHANCED COMPONENTS

- Rounded shape.
- Next-generation compressor that reduces friction between components.
- New Inverter control.
- High-efficiency heat exchanger.
- Optimised pipeline shape.



KXZR2



KXZR2 Hi-COP

HEAT RECOVERY KXZR2

SYSTEM CHARACTERISTICS

These heat recovery systems work with 3 interconnecting pipes and therefore are commonly referred to as 3-pipe systems. These systems offer both heating and cooling in a single indoor unit, based on the room conditions/ requirements. The systems incorporate a highly sophisticated air conditioning control for multiple indoor areas, regardless of the cooling or heating needs, for applications where the building orientation (N, S, E, W) may result in a heat increase/loss on different sides of the same building.

The range starts from a cooling capacity of 8 HP (22.4 kW), up to 24HP (67.0 kW).

The outdoor units can also be installed in "pairs" or in "triple combination", reaching 60HP/168.0 kW on a single system.

HEAT RECOVERY SYSTEMS

The interconnection piping system has a unique arrangement with two of the interconnecting pipes passing through a PFD distribution controller and the third tube connected directly to each indoor unit from the main pipe path.

This reduces installation times and the number of braze-welded connections on the site. The PFD distribution controllers are available for single connection or as a 4-way combined PFD connection, with each connected unit characterised by independent cooling or heating.

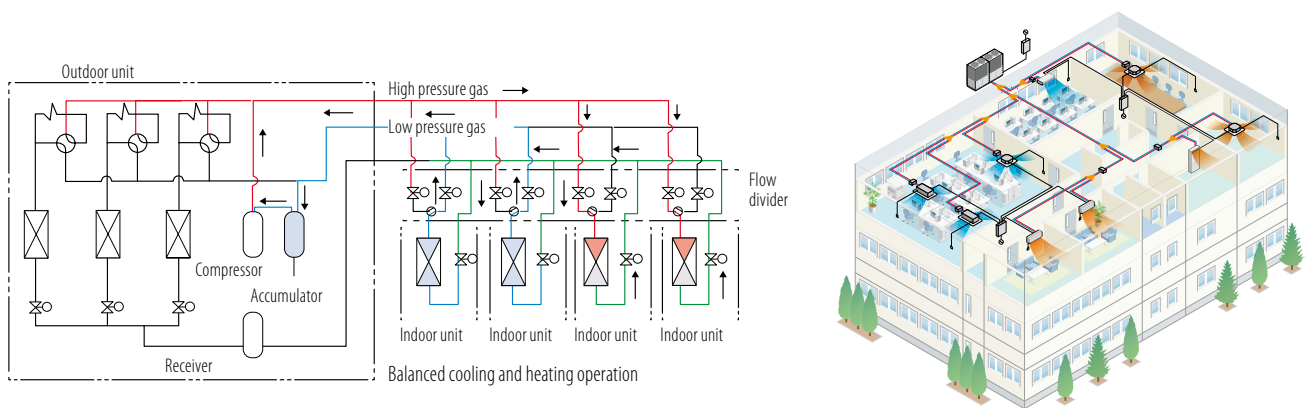

During defrost or during automatic compressor protection, activated every hour during heating, the heating operation stops and restarts temporarily after a specific time interval.

The series is equipped with the same automatic compressor protection even in cooling mode.

During this protection period, only the air flow is active and the cooling operation restarts at the end of a specific time interval.

This model is not suitable for the use of annual cooling operations, for example for the server room, especially in areas where the outdoor air temperature falls below 5° C.

WIDE RANGE OF OPERATION

The KXZR series has an extensible system design, considering a heating range at low temperature conditions down to -20° C, and a cooling range up to 46° C (previous model: 43° C).

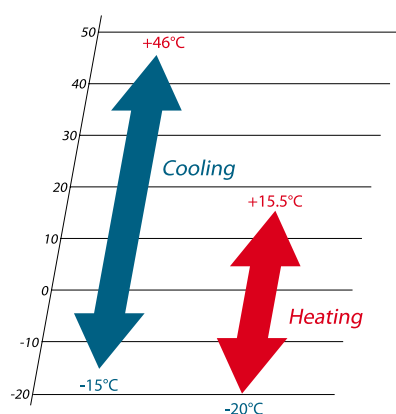

CONNECTABLE INDOOR UNITS

It is possible to connect up to 80 indoor units to the outdoor unit of greater power size. 14 different types of indoor units are available, visible or recessed, in different sizes, for a total of 81 overall possibilities.

DESIGN FLEXIBILITY

Total power of the indoor units

HP	KXZR
8~16	200%
17~34	160%
36~60	130%

- Where total power is higher than 130%, an additional refrigerant charge is required on site.
- With 8-34HP systems, if one or more of the FDK, FDFL, FDFU and/or FDFW series are connected to the system, the total power of the indoor units cannot exceed 130%.

HEAT RECOVERY KXZR2

SYSTEM CHARACTERISTICS

ENERGY EFFICIENCY IN HEAT RECOVERY MODE

High efficiency when cooling and heating occur simultaneously. System control maximises efficiency up to a maximum COP of 9.0* in both cooling and heating mode.

* Data obtained at 8HP in an outdoor temperature condition of 16°C DB/12°C WB, in a refrigerated room of 27°C DB/19°C WB, and in a heated room of 20°C DB/14.5°C WB.

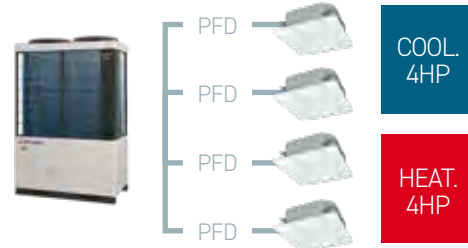
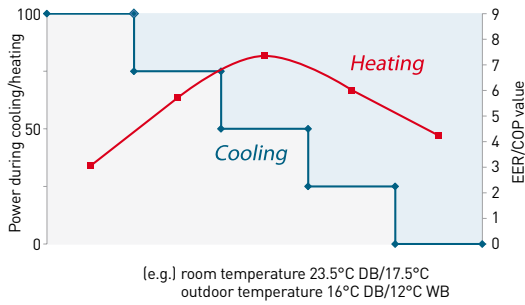

MAX COP > 9.0

Conditions:
FDC 224 KXZRE2
50% indoor units in cooling mode [27°C DB/19°C]
50% indoor units in heating mode [20°C DB/14.5°C]
Outdoor temperature 16°C DB/12°C WB

IMPROVED COOLING CAPACITY AT LOW OUTDOOR TEMPERATURE

The small partitions of the exchanger and the internal pressure control allow the outdoor unit to operate in cooling mode even in low outdoor temperature conditions, for greater capacity with very low temperatures (-5°C) compared to the previous model.

In the previous model, in the presence of a strong heating demands and simultaneous low cooling demands in low outdoor temperature conditions, the pressure control is adjusted to maintain a greater heating power compared to a sufficient cooling power.

The new heat exchanger and pressure control adopted in the KXZR series has improved operating efficiency in heating and cooling*.

* The cooling system has priority for the required heating mode compared to a very low cooling demand, where most of the indoor units are used in heating mode.

Supply air temperature in the cooled room

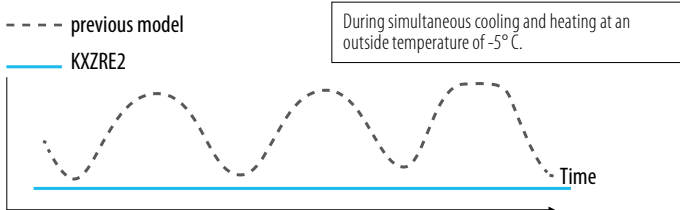

REFRIGERANT CONNECTIONS

VRF-T systems are manufactured to the highest standards of quality and reliability and it is therefore essential for the installation procedures and materials to have the same qualitative features, to ensure trouble-free long-term operation. It is advisable to use high quality copper refrigerant piping, in coils or in straight, semi-rigid lengths. The copper piping should be chosen considering the higher operating pressure of R410A refrigerant gas and the increased pressure circulating in the system produced by reverse cycle operation. All materials used must comply with European standards (EN 12735). The branch pipe kits supplied must be used to connect the indoor units and the manifold kits must be used to connect the outdoor units (if necessary). It is forbidden to use standard accessories (elbow pipes, T-joints etc.). The branch pipes must be installed according to manufacturer guidelines and must allow a continuous flow of refrigerant in accordance with European standard E378: 2017.

All connecting welds must be made under slight nitrogen pressure to prevent the oxidation of the inner surface of the copper pipes. During installation, no accidental entry of

condensate, dust or any other contaminant must be permitted. Once installation is complete, a leak test must be carried out to check for refrigerant leaks with pressurised nitrogen. The ends of the pipe must be bent and welded and an appropriate service valve affixed.

Additional refrigerant charge

Only R410A refrigerant gas must be used, and this must be added by weight using an electronic meter. The amount of additional refrigerant must be carefully calculated according to the manufacturer's guidelines, defined by the length and diameter of each section of the system piping.

If the longest distance (measured between the outdoor unit and the furthest indoor unit) is 90 m or more (actual length), change the size of the main pipe according to the following table. Even if the longest distance exceeds 90 m (actual length), it is not necessary to change the size of the exhaust gas pipes.

HP		8	10	12	14	16	17	18	20	22	24	26	28	30	32	34	36	38	40	42	44	46	48	50	52	54	56	58	60
Liquid side	Furthest I.U.	ø 9.52		ø 12.7														ø 15.88						ø 19.05					
Intake gas	I.U.	ø 19.05	ø 22.22	ø 28.58														ø 34.92											
Delivery gas	=<90 m	ø 15.88	ø 19.05	ø 22.22														ø 28.58											
Liquid side	Furthest I.U.	ø 12.7		ø 15.88														ø 19.05						ø 22.22					
Intake gas	I.U.	ø 22.22		ø 28.58														ø 34.92											
Delivery gas	=>90 m	ø 15.88	ø 19.05	ø 22.22														ø 28.58											

BRANCH PIPES

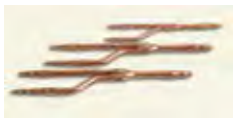

DIS-22-1-RI/DIS-180-1-RI

MANIFOLDS



DOS-2A-3-RI

SINGLE OUTDOOR UNIT

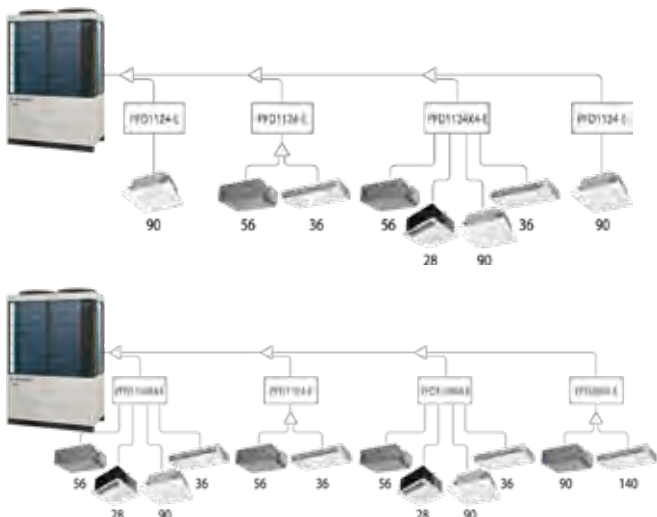

COMBINED OUTDOOR UNITS

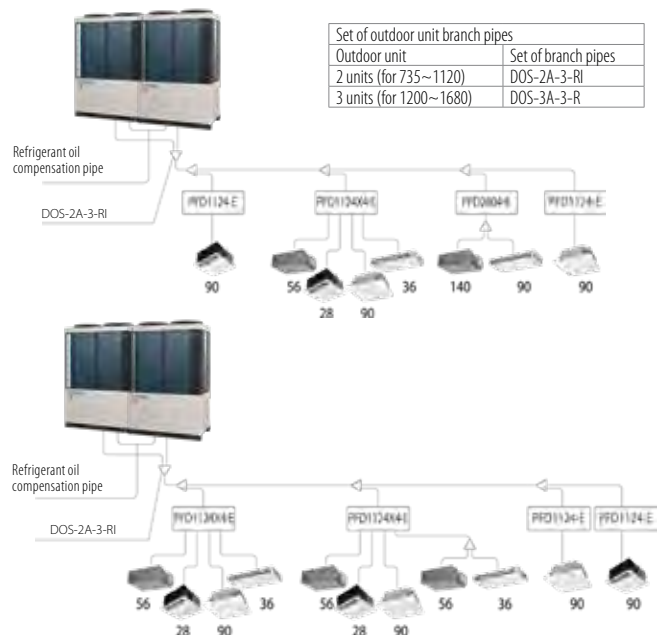

Set of outdoor unit branch pipes	
Outdoor unit	Set of branch pipes
2 units (for 735~1120)	DOS-2A-3-RI
3 units (for 1200~1680)	DOS-3A-3-R

First branch pipe of the indoor unit		Downstream of the PFD	
Indoor units' total capacity	Set of branch pipes	Indoor units' total capacity	Set of branch pipes
~179	DIS-22-1-RI	~179	DIS-22-1B
180~370	DIS-180-1-RI	180~370	DIS-180-1B
371~539	DIS-371-2-RI	371~539	DIS-371-1B
540~	DIS-540-2-RI	540~	DIS-540-3I

HEAT RECOVERY KXZR2

WIRING

VRF MHI systems require highly simplified electrical connections to the indoor units, thanks to a control circuit that uses 2 non-polarised conductors. The outdoor unit can be accessed from all sides for electrical connections (front, rear, bottom, right and left). A separate single-phase or three-phase power supply must be brought in for outdoor and indoor units, depending on the product specification.

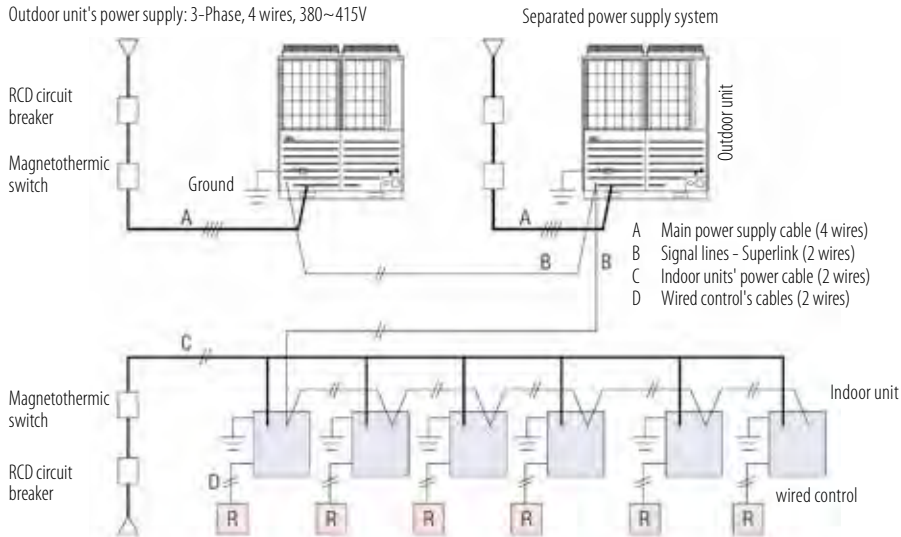

Indoor unit's power supply: 1-Phase 220~240V

IMPORTANT: if the RCD circuit breaker is dedicated solely to protecting against leakage to earth, it will be necessary to install a magnetothermal switch.

CONNECTIONS

SIGNAL LINE

The signal line that connects the outdoor unit to the indoor units is 5 VDC and uses 2 non-polarised conductors marked A1 and B1. For the signal line with 2 conductors, use shielded cables measuring 0.75 or 1.50 mm². Earth the shield on all the indoor and outdoor units.

	0.75 mm ²	1.50 mm ²
~1000 mm	YES	YES
1000~1500 mm	SI	NO

If using combined outdoor units, connect:

- the signal line between indoor and outdoor units, and the signal line between outdoor units that belong to the same refrigerant line, to A1 and B1;
- the signal line between outdoor units belonging to a different refrigerant line to A2 and B2.

CAUTION: star connections on the signal lines are not permitted.

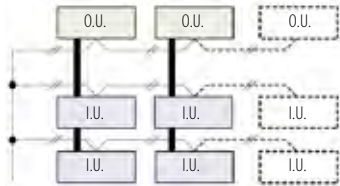

Single outdoor unit

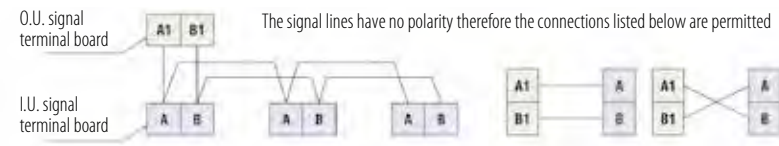

Combined outdoor units

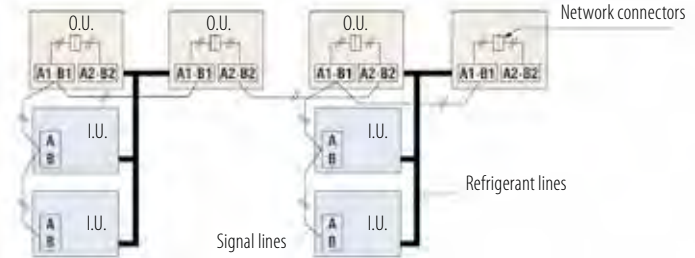

The maximum number of indoor units that can be connected to a signal line is 128, and it is possible to create groups of outdoor and/or indoor units connected to the same outdoor unit or to separate outdoor units, as long as they are connected to the same signal line. The signal line can also be connected by adopting the method described below (multiple connectors).

WIRED CONTROL

The specifications for the connection between the wired remote control and the indoor units (XY connection) are 0.5 mm² x 2 wires. The maximum permitted length is 600 m. If the length exceeds 100 m, refer to the table.

Length (m)	Type of cables
100~200	0.5 mm ² x 2 wires
~300	0.75 mm ² x 2 wires
~400	1.50 mm ² x 2 wires
~600	2.0 mm ² x 2 wires

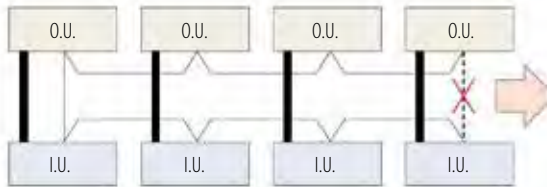

A loop cannot be formed with the signal, therefore the section of the connection indicated with is not permitted

Low noise flow divider

PFD 1124-E, PFD 1804-E, PFD 2804-E, PFD 1124X4-E

Designed and manufactured at Mitsubishi Heavy Industries specialist research laboratories, the PFD flow divider enables all indoor units to be integrated into an air conditioning network, to switch from cooling mode to heating mode, or vice versa, while the whole system remains operational, thus preventing unnecessary power on and power off cycles. By using the optional extension cable for the PFD box, equipped with a connector, it is possible to further separate the PFD box from the indoor unit. This enables a reduction in sound level caused by the PDF box and the flow of refrigerant.



4-outlet PFD



Relay kit

HEAT RECOVERY KXZR2

CONNECTIONS

PFD 1124-E, PFD 1804-E, PFD 2804-E,
PFD 1124X4-E

Selection and control from centralised panel

The remote control settings (such as power on/off of single indoor units, temperature setting, as well as controlling the heating/cooling procedures) are possible via an individual control connected to each indoor unit.

At the same time, together with the individual controls, the SC-SL1N/2NA/4-AE3/BE3 centralised control panels can also be used.

For more details, refer to the Installation Manual.

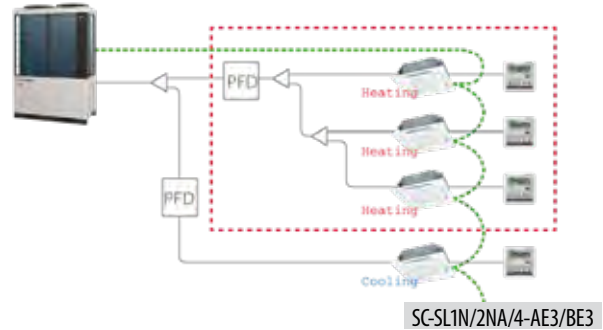

Ease of installation

The PFD flow divider requires only the connection of gas-side piping, including low-pressure piping from the O.U., while the liquid-side piping is connected directly to the I.U. This reduces the number of connections and, consequently, installation times and costs.

Groups of indoor units up to a total capacity of 28 kW can be connected to a single PFD by means of branch pipes, all of which operate in the same mode, cooling or heating. Also available is a 4-connection distributor, PFD1124X4-E, which allows up to 4 groups of indoor units to be connected, operating individually in cooling or heating mode.

The PFD flow divider is connected to the indoor unit via a relay kit (supplied) to be installed within a maximum distance of 2 metres from the indoor unit. The maximum distance between the PFD and the I.U. is 40 metres. The power of the PFD comes directly from the indoor unit.

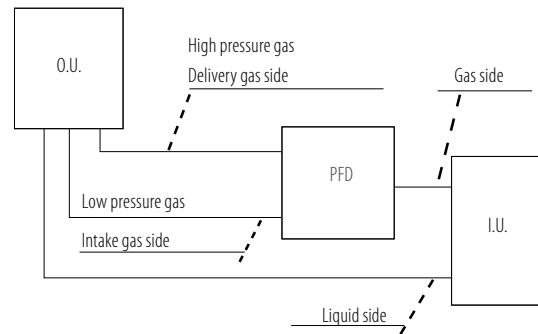
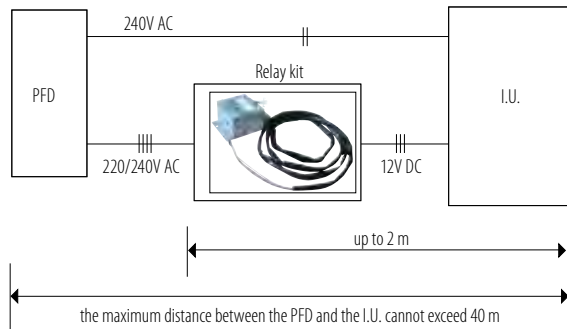

PFD4-15WR-W
15 m Extension Cable for PFD-Box
KXZR (optional)

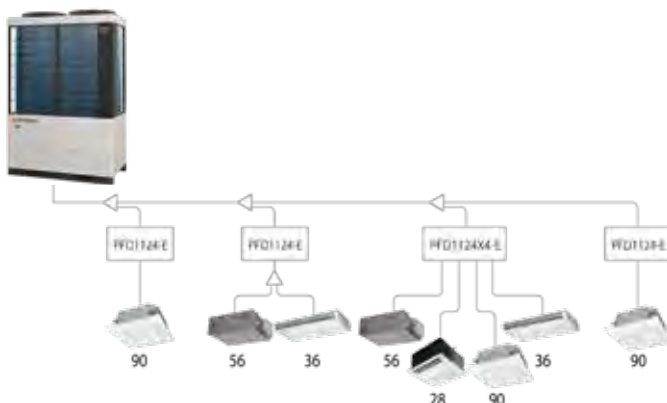

Flow divider	Total I.U. power downstream	Connectable indoor units*
PFD 1124-E	up to 11.20 kW	1-5
PFD 1804-E	up to 18.00 kW	1-8
PFD 2804-E	up to 28.00 kW	1-10
PFD 1124X4-E	up to 37.10 kW total (divided over the 4 connections)	up to 16

* Refer to the technical manuals for specifications.

HEAT RECOVERY KXZR2

KXZR2

CONNECT UP TO 44 INDOOR UNITS/200% CAPACITY

- FDC 224 KXZRE2 22.4 kW
- FDC 280 KXZRE2 28.0 kW
- FDC 335 KXZRE2 33.5 kW

FEATURES

- Maximum energy efficiency: COP 4.25 and EER 3.89 [8 HP]
- Only DC Inverter compressors
- High splitting distance: up to 1000 m in total and with a max. distance between the O.U. and the furthest I.U. of 160 m
- Up to 50 Pa fan static pressure

OPERATING RANGE

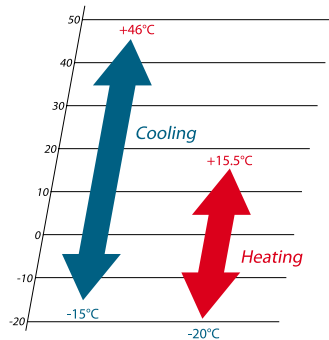

INSTALLATION DIAGRAM

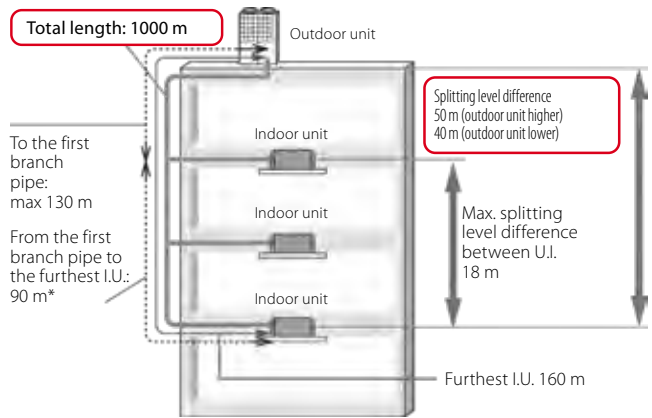

* With difference of length between the farthest indoor unit and the nearest one from the first branch pipe < 40 m.

8~12HP
(22.4~33.5 kW)



Outdoor unit model			FDC 224 KXZRE2	FDC 280 KXZRE2	FDC 335 KXZRE2	
Power class		HP	8	10	12	
Nominal data						
Rated capacity	Cooling	kW	22.40	28.00	33.50	
		Rated power input	kW	5.76	7.39	9.65
		Rated energy efficiency coefficient	EER ¹	3.89	3.79	3.47
Rated capacity	Heating	kW	22.40	28.00	33.50	
		Rated power input	kW	5.27	6.86	8.44
		Rated energy performance coefficient	COP ¹	4.25	4.08	3.97
Seasonal data						
Seasonal energy efficiency index	Cooling	SEER ²	6.21	6.36	7.15	
	Heating	SCOP ²	4.06	4.02	4.43	
Electrical data						
Power supply		Ph-V-Hz	3Ph-380~415V-50Hz			
Rated current	Cooling	A	10.10	12.20	15.80	
	Heating	A	9.10	11.30	13.80	
Maximum current		A	16.00	20.00	21.20	
Refrigerant circuit data						
Refrigerant ³		type (GWP)	R410A (2088)			
Q.ty of refrigerant pre-charge ⁴ (tons of CO ₂ equivalent)		kg	11.5 (24.012)	11.5 (24.012)	11.5 (24.012)	
Piping diameter	Liquid		3/8" (9.52)	3/8" (9.52)	1/2" (12.7)	
	Gas LP	inch (mm)	3/4" (19.05)	7/8" (22.22)	1" (25.4)	
	Gas HP		5/8" (15.88)	3/4" (19.05)	3/4" (19.05)	
Product specifications						
Dimensions	HxLxD	mm	1697x1350x720	1697x1350x720	1697x1350x720	
Net weight		kg	305	305	305	
Sound power level	Max	dB(A)	77	76	82	
Sound pressure level	Max	dB(A)	58	57	64	
Volume of air treated	Standard	m ³ /h	13500	13500	17640	
Fan static pressure	Max	Pa	50	50	50	
Operating range (outdoor temperature)	Cooling	°C	-15~46	-15~46	-15~46	
	Heating	°C	-20~15.5	-20~15.5	-20~15.5	
Connectable indoor units ⁵	Min ~ Max	nb.	1 ~ 29	1 ~ 37	1 ~ 44	
	Capacity	%	50 ~ 200	50 ~ 200	50 ~ 200	

1. Value measured according to the harmonised standard EN 14511. 2. EU Regulations No. 206/2012 - No. 2281/2016 - Value measured according to the harmonised standard EN14825. 3. Refrigerant leakage contributes to climate change. When released into the atmosphere, refrigerants with a lower global warming potential (GWP) contribute less to global warming than those with a higher GWP. This appliance contains a refrigerant with a GWP of 2088. If 1 kg of this refrigerant fluid were released into the atmosphere, therefore, the impact on global warming would be 2088 times higher than 1 kg of CO₂, over a period of 100 years. Under no circumstances should the user try to intervene on the refrigerant circuit or disassemble the product. Always contact qualified personnel if necessary. 4. For the calculation of the additional refrigerant charge, refer to the labels positioned inside and outside the unit. 5. When connecting indoor units of type FDK, FDFL, FDFU or FDFW the upper limit is always 130%.

HEAT RECOVERY KXZR2

KXZR2

CONNECT UP TO 71 INDOOR UNITS/160% CAPACITY (200% FOR FDC 400~450)

FDC 400 KXZRE2	40.0 kW	FDC 560 KXZRE2	56.0 kW
FDC 450 KXZRE2	45.0 kW	FDC 615 KXZRE2	61.5 kW
FDC 475 KXZRE2	47.5 kW	FDC 670 KXZRE2	67.0 kW
FDC 500 KXZRE2	50.0 kW		

FEATURES

- Maximum energy efficiency: COP 4.10 and EER 3.46 [14 HP]
- Only DC Inverter compressors
- High splitting distance: up to 1000 m in total and with a max. distance between the O.U. and the furthest I.U. of 160 m
- Up to 50 Pa fan static pressure

OPERATING RANGE

14~24HP
(40.0~67.0 kW)

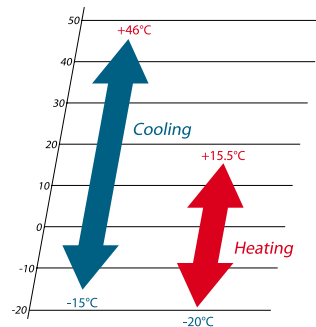

INSTALLATION DIAGRAM

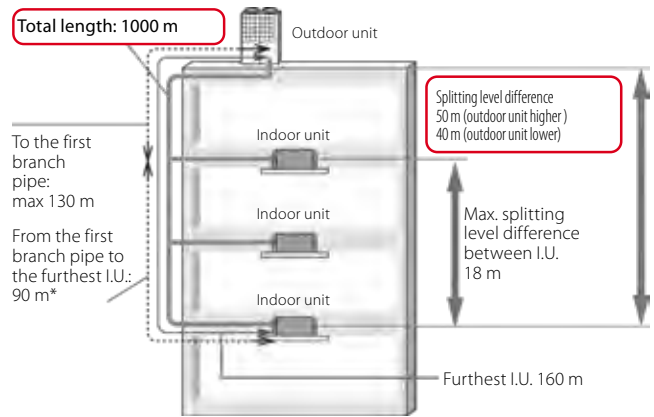

* With difference of length between the furthest indoor unit and the nearest one from the first branch pipe < 40 m.

Outdoor unit model			FDC 400 KXZRE2	FDC 450 KXZRE2	FDC 475 KXZRE2	FDC 500 KXZRE2	FDC 560 KXZRE2	FDC 615 KXZRE2	FDC 670 KXZRE2
Power class		HP	14	16	17	18	20	22	24
Nominal data									
Rated capacity	Cooling	kW	40.00	45.00	47.50	50.00	56.00	61.50	67.00
		kW	11.56	14.47	14.84	15.20	19.31	21.35	25.57
		EER ¹	3.46	3.11	3.20	3.29	2.90	2.88	2.62
Rated capacity	Heating	kW	40.00	45.00	47.50	50.00	56.00	61.50	63.00
		kW	9.76	11.39	11.67	12.69	14.93	16.14	17.45
		COP ¹	4.10	3.95	4.07	3.94	3.75	3.81	3.61
Seasonal data									
Seasonal energy efficiency index	Cooling	SEER ²	6.78	6.29	6.6	7.01	6.26	6.05	5.88
	Heating	SCOP ²	4.39	4.33	4.27	4.39	4.29	4.34	4.50
Electrical data									
Power supply		Ph-V-Hz	3Ph-380~415V-50Hz						
Rated current	Cooling	A	18.50	23.10	24.00	24.60	31.20	34.50	41.30
	Heating	A	15.90	18.60	18.90	20.50	24.10	26.10	28.20
Maximum current		A	30.00	32.00	40.40	41.00	41.60	42.00	42.40
Refrigerant circuit data									
Refrigerant ³		type (GWP)	R410A (2088)						
Q.ty of refrigerant pre-charge ⁴ (tons of CO ₂ equivalent)		kg	11.5 (24.012)	11.5 (24.012)	11.5 (24.012)	11.5 (24.012)	11.5 (24.012)	11.5 (24.012)	11.5 (24.012)
Piping diameter	Liquid	inch (mm)	1/2" (12.7)	1/2" (12.7)	1/2" (12.7)	1/2" (12.7)	1/2" (12.7)	1/2" (12.7)	1/2" (12.7)
	Gas LP	inch (mm)	1" (25.4)	1-1/8" (28.58)	1-1/8" (28.58)	1-1/8" (28.58)	1-1/8" (28.58)	1-1/8" (28.58)	1-1/8" (28.58)
	Gas HP	inch (mm)	7/8" (22.22)	7/8" (22.22)	7/8" (22.22)	7/8" (22.22)	7/8" (22.22)	1" (25.4)	1" (25.4)
Product specifications									
Dimensions		HxLxD	mm	2052x1350x720	2052x1350x720	2052x1350x720	2052x1350x720	2052x1350x720	2052x1350x720
Net weight			kg	372	372	420	420	420	420
Sound power level		Max	dB(A)	82	82	82	82	83	83
Sound pressure level		Max	dB(A)	62	62	62	62	65	65
Volume of air treated		Standard	m ³ /h	18240	18240	18000	18000	18000	18000
Fan static pressure		Max	Pa	50	50	50	50	50	50
Operating range (outdoor temperature)		Cooling	°C	-15~46	-15~46	-15~46	-15~46	-15~46	-15~46
		Heating	°C	-20~15.5	-20~15.5	-20~15.5	-20~15.5	-20~15.5	-20~15.5
Connectable indoor units ⁵		Min ~ Max	nb.	1 ~ 53	1 ~ 60	1 ~ 50	1 ~ 53	1 ~ 59	2 ~ 71
		Capacity	%	50 ~ 200	50 ~ 200	50 ~ 160	50 ~ 160	50 ~ 160	50 ~ 160

1. Value measured according to the harmonised standard EN 14511. 2. EU Regulations No. 206/2012 - No. 2281/2016 - Value measured according to the harmonised standard EN 14825. 3. Refrigerant leakage contributes to climate change. When released into the atmosphere, refrigerants with a lower global warming potential (GWP) contribute less to global warming than those with a higher GWP. This appliance contains a refrigerant with a GWP of 2088. If 1 kg of this refrigerant fluid were released into the atmosphere, therefore, the impact on global warming would be 2088 times higher than 1 kg of CO₂ over a period of 100 years. Under no circumstances should the user try to intervene on the refrigerant circuit or disassemble the product. Always contact qualified personnel if necessary. 4. For the calculation of the additional refrigerant charge, refer to the labels positioned inside and outside the unit. 5. When connecting indoor units of type FDK, FDL, FDU or FDFW the upper limit is always 130%.

HEAT RECOVERY KXZR2

KXZR2 - MODULAR OUTDOOR UNITS

CONNECT UP TO 78 INDOOR UNITS (FDC 735)
AND UP TO 80 INDOOR UNITS (FDC 800~1120)
160% CAPACITY (FDC 735~950) AND UP TO 130%
CAPACITY (FDC 1000~1120)

FDC 735 KXZRE2 (FDC 335+FDC 400) 73.5 kW
FDC 800 KXZRE2 (FDC 400+FDC 400) 80.0 kW
FDC 850 KXZRE2 (FDC 400+FDC 450) 85.0 kW
FDC 900 KXZRE2 (FDC 450+FDC 450) 90.0 kW
FDC 950 KXZRE2 (FDC 475+FDC 750) 95.0 kW
FDC 1000 KXZRE2 (FDC 500+FDC 500) 100.0 kW
FDC 1060 KXZRE2 (FDC 500+FDC 560) 106.0 kW
FDC 1120 KXZRE2 (FDC 560+FDC 560) 112.0 kW

FEATURES

- Maximum energy efficiency: COP 4.10 (28HP); EER 3.47 (26HP)
- Only DC Inverter compressors
- High splitting distance: up to 1000 m in total and with a max. distance between the O.U. and the farthest I.U. e la U.I. of 160 m
- Up to 85 Pa fan static pressure

OPERATING RANGE

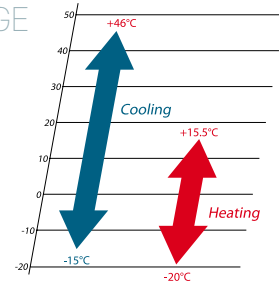

26HP (73.5 kW)



28~40HP (80.0~112.0 kW)

COMBINATIONS

Outdoor unit model			FDC 735 KXZRE2	FDC 800 KXZRE2	FDC 850 KXZRE2	FDC 900 KXZRE2	FDC 950 KXZRE2	FDC 1000 KXZRE2	FDC 1060 KXZRE2	FDC 1120 KXZRE2			
Combinations			FDC 335 KXZRE2	FDC 400 KXZRE2	FDC 400 KXZRE2	FDC 450 KXZRE2	FDC 475 KXZRE2	FDC 500 KXZRE2	FDC 500 KXZRE2	FDC 560 KXZRE2			
			FDC 400 KXZRE2	FDC 400 KXZRE2	FDC 450 KXZRE2	FDC 450 KXZRE2	FDC 475 KXZRE2	FDC 500 KXZRE2	FDC 560 KXZRE2	FDC 560 KXZRE2			
Power class			HP	26	28	30	32	34	36	38	40		
Rated capacity			kW	73.50	80.00	85.00	90.00	95.00	100.00	106.00	112.00		
Rated power input			kW	21.21	23.12	26.03	28.94	29.68	30.40	34.51	38.62		
Rated energy efficiency coefficient			EER ¹	3.47	3.46	3.27	3.11	3.20	3.29	3.07	2.90		
Rated capacity			kW	73.50	80.00	85.00	90.00	95.00	100.00	106.00	112.00		
Rated power input			kW	18.20	19.52	21.15	22.78	23.34	25.38	27.62	29.86		
Rated energy performance coefficient			COP ¹	4.04	4.10	4.02	3.95	4.07	3.94	3.84	3.75		
Electrical data													
Power supply			Ph-V-Hz	3Ph-380~415V-50Hz									
Rated current			Cooling	A	34.30	37.00	41.60	46.30	48.00	49.10	55.80	62.40	
			Heating	A	29.70	31.90	34.60	37.20	37.70	41.00	44.60	48.30	
Maximum current			A	51.20	60.00	62.00	64.00	80.80	82.00	82.60	83.20		
Refrigerant circuit data													
Refrigerant ²			type (GWP)	R410A (2088)									
Qty of refrigerant pre-charge ³ (tons of CO ₂ equivalent)			kg	23 (48.024)	23 (48.024)	23 (48.024)	23 (48.024)	23 (48.024)	23 (48.024)	23 (48.024)	23 (48.024)		
Piping diameter ⁴			inch (mm)	Liquid	5/8" (15.88)	5/8" (15.88)	5/8" (15.88)	5/8" (15.88)	5/8" (15.88)	5/8" (15.88)	3/4" (19.05)	3/4" (19.05)	
				Gas LP	1-1/4" (31.75)	1-1/4" (31.75)	1-1/4" (31.75)	1-1/4" (31.75)	1-1/4" (31.75)	1-1/4" (31.75)	1-1/2" (38.1)	1-1/2" (38.1)	1-1/2" (38.1)
				Gas HP	1" (25.4)	1-1/8" (28.58)	1-1/8" (28.58)	1-1/8" (28.58)	1-1/8" (28.58)	1-1/8" (28.58)	1-1/8" (28.58)	1-1/4" (31.75)	1-1/4" (31.75)
				Oil balancing	3/8" (9.52)	3/8" (9.52)	3/8" (9.52)	3/8" (9.52)	3/8" (9.52)	3/8" (9.52)	3/8" (9.52)	3/8" (9.52)	3/8" (9.52)
Product specifications													
Dimensions			HxLxD	2052x2700x720									
Net weight			kg	677	744	744	744	840	840	840	840		
Connectable indoor units ⁵			Min ~ Max	nb.	2 ~ 78	2 ~ 80	2 ~ 80	2 ~ 80	2 ~ 80	2 ~ 80	2 ~ 80	2 ~ 80	
			Capacity	%	50 ~ 160	50 ~ 160	50 ~ 160	50 ~ 160	50 ~ 160	50 ~ 130	50 ~ 130	50 ~ 130	

1. Value measured according to the harmonised standard EN 14511.2. Refrigerant leakage contributes to climate change. When released into the atmosphere, refrigerants with a lower global warming potential (GWP) contribute less to global warming than those with a higher GWP. This appliance contains a refrigerant with a GWP of 2088. If 1 kg of this refrigerant fluid were released into the atmosphere, therefore, the impact on global warming would be 2088 times higher than 1 kg of CO₂, over a period of 100 years. Under no circumstances should the user try to intervene on the refrigerant circuit or disassemble the product. Always contact qualified personnel if necessary. 3. For the calculation of the additional refrigerant charge, refer to the labels positioned inside and outside the unit. 4. The diameters indicated refer to the section up to the first junction, with an equivalent length of less than 90 m. 5. When connecting indoor units of type FDK, FDFL, FDFU or FDFW the upper limit is always 130%.

HEAT RECOVERY KXZR2

KXZR2 - MODULAR OUTDOOR UNITS

CONNECT UP TO 80 INDOOR UNITS/130% CAPACITY

FDC 1200 KXZRE2 (FDC 400+FDC 400+FDC 400)	120.0 kW
FDC 1250 KXZRE2 (FDC 400+FDC 400+FDC 450)	125.0 kW
FDC 1300 KXZRE2 (FDC 400+FDC 450+FDC 450)	130.0 kW
FDC 1350 KXZRE2 (FDC 450+FDC 450+FDC 450)	135.0 kW
FDC 1425 KXZRE2 (FDC 475+FDC 475+FDC 475)	142.5 kW
FDC 1450 KXZRE2 (FDC 475+FDC 475+FDC 500)	145.0 kW
FDC 1500 KXZRE2 (FDC 500+FDC 500+FDC 500)	150.0 kW
FDC 1560 KXZRE2 (FDC 500+FDC 500+FDC 560)	156.0 kW
FDC 1620 KXZRE2 (FDC 500+FDC 560+FDC 560)	162.0 kW
FDC 1680 KXZRE2 (FDC 560+FDC 560+FDC 560)	168.0 kW

FEATURES

- Maximum energy efficiency: COP 4.10 and EER 3.46 (42HP)
- Only DC Inverter compressors
- High splitting distance: up to 1000 m in total and with a max. distance between the O.U. and the farthest I.U. e la U.I. of 160 m
- Up to 85 Pa fan static pressure

OPERATING RANGE

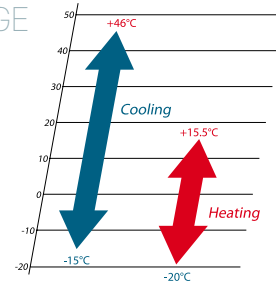

42~60HP
(120.0~168.0 kW)

COMBINATIONS

Outdoor unit model			FDC 1200 KXZRE2	FDC 1250 KXZRE2	FDC 1300 KXZRE2	FDC 1350 KXZRE2	FDC 1425 KXZRE2	FDC 1450 KXZRE2	FDC 1500 KXZRE2	FDC 1560 KXZRE2	FDC 1620 KXZRE2	FDC 1680 KXZRE2		
Combinations			FDC 400 KXZRE2	FDC 400 KXZRE2	FDC 400 KXZRE2	FDC 450 KXZRE2	FDC 475 KXZRE2	FDC 475 KXZRE2	FDC 500 KXZRE2	FDC 500 KXZRE2	FDC 500 KXZRE2	FDC 560 KXZRE2		
Power class			HP	42	44	46	48	50	52	54	56	60		
Rated capacity			kW	120.00	125.00	130.00	135.00	142.50	145.00	150.00	156.00	162.00		
Rated power input			kW	34.68	37.59	40.50	43.41	44.52	44.88	45.60	49.71	53.82		
Rated energy efficiency coefficient			EER ¹	3.46	3.33	3.21	3.11	3.20	3.23	3.29	3.14	3.01		
Rated capacity			kW	120.00	125.00	130.00	135.00	142.50	145.00	150.00	156.00	162.00		
Rated power input			kW	29.28	30.91	32.54	34.17	35.01	36.03	38.07	40.31	42.55		
Rated energy performance coefficient			COP ¹	4.10	4.04	4.00	3.95	4.07	4.02	3.94	3.87	3.81		
Electrical data														
Power supply			Ph-V-Hz	3Ph-380~415V-50Hz										
Rated current			Cooling	A	55.50	60.10	64.80	69.40	72.00	72.50	73.70	80.30	87.00	
			Heating	A	47.80	50.50	53.20	55.80	56.60	58.20	61.50	65.20	68.80	
Maximum current			A	90.00	92.00	94.00	96.00	121.20	121.80	123.00	123.60	124.20		
Refrigerant circuit data														
Refrigerant ²			type (GWP)	R410A (2088)										
Q.ty of refrigerant pre-charge ³ (tons of CO2 equivalent)			kg	34.5 (72.036)	34.5 (72.036)	34.5 (72.036)	34.5 (72.036)	34.5 (72.036)	34.5 (72.036)	34.5 (72.036)	34.5 (72.036)	34.5 (72.036)		
Piping diameter ⁴			inch (mm)	Liquid	3/4" (19.05)	3/4" (19.05)	3/4" (19.05)	3/4" (19.05)	3/4" (19.05)	3/4" (19.05)	3/4" (19.05)	3/4" (19.05)		
				Gas LP	1-1/2" (38.1)	1-1/2" (38.1)	1-1/2" (38.1)	1-1/2" (38.1)	1-1/2" (38.1)	1-1/2" (38.1)	1-1/2" (38.1)	1-1/2" (38.1)	1-1/2" (38.1)	1-1/2" (38.1)
				Gas HP	1-1/4" (31.75)	1-1/4" (31.75)	1-1/4" (31.75)	1-1/4" (31.75)	1-1/4" (31.75)	1-1/4" (31.75)	1-1/4" (31.75)	1-1/4" (31.75)	1-1/4" (31.75)	1-1/4" (31.75)
				Oil balancing	3/8" (9.52)	3/8" (9.52)	3/8" (9.52)	3/8" (9.52)	3/8" (9.52)	3/8" (9.52)	3/8" (9.52)	3/8" (9.52)	3/8" (9.52)	3/8" (9.52)
Product specifications														
Dimensions			HxLxD	mm 2052x4050x720										
Net weight			kg	1116	1116	1116	1116	1260	1260	1260	1260	1260		
Connectable indoor units ⁵			Min ~ Max	nb.	3 ~ 80	3 ~ 80	3 ~ 80	3 ~ 80	3 ~ 80	3 ~ 80	3 ~ 80	3 ~ 80		
			Capacity	%	50 ~ 130	50 ~ 130	50 ~ 130	50 ~ 130	50 ~ 130	50 ~ 130	50 ~ 130	50 ~ 130	50 ~ 130	

1. Value measured according to the harmonised standard EN 14511.2. Refrigerant leakage contributes to climate change. When released into the atmosphere, refrigerants with a lower global warming potential (GWP) contribute less to global warming than those with a higher GWP. This appliance contains a refrigerant with a GWP of 2088. If 1 kg of this refrigerant fluid were released into the atmosphere, therefore, the impact on global warming would be 2088 times higher than 1 kg of CO₂, over a period of 100 years. Under no circumstances should the user try to intervene on the refrigerant circuit or disassemble the product. Always contact qualified personnel if necessary. 3. For the calculation of the additional refrigerant charge, refer to the labels positioned inside and outside the unit. 4. The diameters indicated refer to the section up to the first junction, with an equivalent length of less than 90 m. 5. When connecting indoor units of type FDK, FDFL, FDFU or FDFW the upper limit is always 130%.

KXZRX2 Hi-COP VRF-T MODULAR SYSTEM

Record efficiency in heating and cooling

Greater energy efficiency with KXZRXE2 heat recovery systems, in any combination of outdoor units.



16~36HP
(45.0~100 kW)

HEAT RECOVERY KXZR2

KXZRX2 Hi-COP

CONNECT UP TO 71 INDOOR UNITS/160% CAPACITY (200% FOR FDC 450)

- FDC 450 KXZRXE2 (FDC 224+FDC 224) 45.0 kW
- FDC 500 KXZRXE2 (FDC 224+FDC 280) 50.0 kW
- FDC 560 KXZRXE2 (FDC 280+FDC 280) 56.0 kW
- FDC 615 KXZRXE2 (FDC 280+FDC 335) 61.5 kW
- FDC 670 KXZRXE2 (FDC 335+FDC 335) 67.0 kW

FEATURES

- Maximum energy efficiency: COP 4.27 and EER 3.91 (16HP)
- Only DC Inverter compressors
- Splitting distance: up to 1000 m in total and with a max. distance between the O.U. and the furthest I.U. of 160 m
- Up to 85 Pa fan static pressure



16~24HP
(45.0~67.0 kW)

OPERATING RANGE

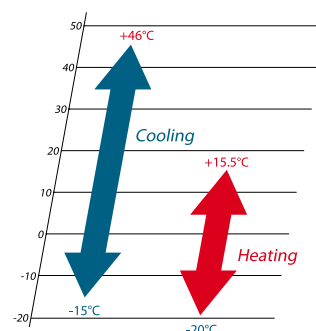

COMBINATIONS

Outdoor unit model			FDC 450 KXZRXE2	FDC 500 KXZRXE2	FDC 560 KXZRXE2	FDC 615 KXZRXE2	FDC 670 KXZRXE2
Combinations			FDC 224 KXZRE2 FDC 224 KXZRE2	FDC 224 KXZRE2 FDC 280 KXZRE2	FDC 280 KXZRE2 FDC 280 KXZRE2	FDC 280 KXZRE2 FDC 335KXZRE2	FDC 335 KXZRE2 FDC 335 KXZRE2
Power class			16	18	20	22	24
Rated capacity	Cooling	HP	45.00	50.00	56.00	61.50	67.00
		kW	11.52	13.15	14.78	17.04	19.30
Rated energy efficiency coefficient	Cooling	EER ¹	3.91	3.80	3.79	3.61	3.47
		kW	45.00	50.00	56.00	61.50	67.00
Rated power input	Heating	kW	10.54	12.13	13.72	15.30	16.88
		COP ¹	4.27	4.12	4.08	4.02	3.97
Electrical data							
Power supply		Ph-V-Hz	3Ph-380~415V-50Hz				
Rated current	Cooling	A	20.20	22.30	24.40	28.00	31.50
	Heating	A	18.20	20.40	22.70	25.10	27.60
Maximum current		A	32.00	36.00	40.00	41.20	42.40
Refrigerant circuit data							
Refrigerant ²		type (GWP)	R410A (2088)				
Q.ty of refrigerant pre-charge ³ (tons of CO2 equivalent)		kg	23 (48.024)	23 (48.024)	23 (48.024)	23 (48.024)	23 (48.024)
Piping diameter ⁴	Liquid	inch	1/2" (12.7)	1/2" (12.7)	1/2" (12.7)	1/2" (12.7)	1/2" (12.7)
	Gas LP	inch	1-1/8" (28.58)	1-1/8" (28.58)	1-1/8" (28.58)	1-1/8" (28.58)	1-1/8" (28.58)
	Gas HP	mm	7/8" (22.2)	7/8" (22.2)	7/8" (22.2)	1" (25.4)	1" (25.4)
	Oil balancing		3/8" (9.52)	3/8" (9.52)	3/8" (9.52)	3/8" (9.52)	3/8" (9.52)
Product specifications							
Dimensions		HxLxD	mm 1697x2700x720				
Net weight		kg	610	610	610	610	610
Connectable indoor units ⁵	Min ~ Max	nb.	2 ~ 60	2 ~ 53	2 ~ 59	2 ~ 65	2 ~ 71
	Capacity	%	80 ~ 200	80 ~ 160	80 ~ 160	80 ~ 160	80 ~ 160

1. Value measured according to the harmonised standard EN 14511.2. Refrigerant leakage contributes to climate change. When released into the atmosphere, refrigerants with a lower global warming potential (GWP) contribute less to global warming than those with a higher GWP. This appliance contains a refrigerant with a GWP of 2088. If 1 kg of this refrigerant fluid were released into the atmosphere, therefore, the impact on global warming would be 2088 times higher than 1 kg of CO₂, over a period of 100 years. Under no circumstances should the user try to intervene on the refrigerant circuit or disassemble the product. Always contact qualified personnel if necessary. 3. For the calculation of the additional refrigerant charge, refer to the labels positioned inside and outside the unit. 4. The diameters indicated refer to the section up to the first junction, with an equivalent length of less than 90 m. 5. When connecting indoor units of type FDK, FDFL, FDFU or FDFW the upper limit is always 130%.

HEAT RECOVERY KXZR2

KXZR2 Hi-COP

CONNECT UP TO 80 INDOOR UNITS/160% CAPACITY (130% FOR FDC 1000)

- FDC 735 KXZR2E2 (FDC 224+FDC 224+FDC 280) 73.5 kW
- FDC 800 KXZR2E2 (FDC 224+FDC 280+FDC 280) 80.0 kW
- FDC 850 KXZR2E2 (FDC 280+FDC 280+FDC 280) 85.0 kW
- FDC 900 KXZR2E2 (FDC 280+FDC 280+FDC 335) 90.0 kW
- FDC 950 KXZR2E2 (FDC 280 +FDC 335+FDC 335) 95.0 kW
- FDC 1000 KXZR2E2 (FDC 335+FDC 335+ FDC 335) 100.0 kW

FEATURES

- Maximum energy efficiency: COP 4.22 and EER 3.89 (26HP)
- Only DC Inverter compressors
- Splitting distance: up to 1000 m in total and with a max. distance between the O.U. and the furthest I.U. of 160 m
- Up to 85 Pa fan static pressure

OPERATING RANGE

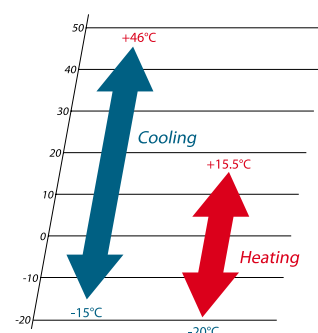

26~36HP
(73.5~100.0 kW)

COMBINATIONS

Outdoor unit model			FDC 735 KXZR2E2	FDC 800 KXZR2E2	FDC 850 KXZR2E2	FDC 900 KXZR2E2	FDC 950 KXZR2E2	FDC 1000 KXZR2E2	
Combinations			FDC 224 KXZR2E2	FDC 224 KXZR2E2	FDC 280 KXZR2E2	FDC 280 KXZR2E2	FDC 280 KXZR2E2	FDC 335 KXZR2E2	
			FDC 224 KXZR2E2	FDC 280 KXZR2E2	FDC 280 KXZR2E2	FDC 280 KXZR2E2	FDC 335 KXZR2E2	FDC 335 KXZR2E2	
Power class			HP	26	28	30	32	34	
Rated capacity			kW	73.50	80.00	85.00	90.00	95.00	
Rated power input			kW	18.91	20.54	22.17	24.43	26.69	
Rated energy efficiency coefficient			EER ¹	3.89	3.89	3.83	3.68	3.56	
Rated capacity			kW	73.50	80.00	85.00	90.00	95.00	
Rated power input			kW	17.40	18.99	20.58	22.16	23.74	
Rated energy performance coefficient			COP ¹	4.22	4.21	4.13	4.06	4.00	
Electrical data									
Power supply			Ph-V-Hz	3Ph-380~415V-50Hz					
Rated current			Cooling	A	32.40	34.50	36.60	40.20	43.70
			Heating	A	29.50	31.80	34.00	36.40	38.90
Maximum current			A	52.00	56.00	60.00	61.20	62.40	63.60
Refrigerant circuit data									
Refrigerant ²			type (GWP)	R410A (2088)					
Q.ty of refrigerant pre-charge ³ (tons of CO2 equivalent)			kg	34.5 (72.036)	34.5 (72.036)	34.5 (72.036)	34.5 (72.036)	34.5 (72.036)	34.5 (72.036)
Piping diameter ⁴			Liquid	5/8" (15.88)	5/8" (15.88)	5/8" (15.88)	5/8" (15.88)	5/8" (15.88)	5/8" (15.88)
			Gas LP	1-1/4" (31.75)	1-1/4" (31.75)	1-1/4" (31.75)	1-1/4" (31.75)	1-1/4" (31.75)	1-1/2" (38.1)
			Gas HP	1" (25.4)	1-1/8" (28.58)	1-1/8" (28.58)	1-1/8" (28.58)	1-1/8" (28.58)	1-1/8" (28.58)
			Oil balancing	3/8" (9.52)	3/8" (9.52)	3/8" (9.52)	3/8" (9.52)	3/8" (9.52)	3/8" (9.52)
Product specifications									
Dimensions			HxLxD	mm 1697x4050x720					
Net weight			kg	915	915	915	915	915	915
Connectable indoor units ⁵			Min ~ Max	nb.	3 ~ 78	3 ~ 80	3 ~ 80	3 ~ 80	3 ~ 80
			Capacity	%	80 ~ 160	80 ~ 160	80 ~ 160	80 ~ 160	80 ~ 130

1. Value measured according to the harmonised standard EN 14511.2. Refrigerant leakage contributes to climate change. When released into the atmosphere, refrigerants with a lower global warming potential (GWP) contribute less to global warming than those with a higher GWP. This appliance contains a refrigerant with a GWP of 2088. If 1 kg of this refrigerant fluid were released into the atmosphere, therefore, the impact on global warming would be 2088 times higher than 1 kg of CO₂, over a period of 100 years. Under no circumstances should the user try to intervene on the refrigerant circuit or disassemble the product. Always contact qualified personnel if necessary. 3. For the calculation of the additional refrigerant charge, refer to the labels positioned inside and outside the unit. 4. The diameters indicated refer to the first junction, with an equivalent length of less than 90 m. 5. When connecting indoor units of type FDk, FDFL, FDFU or FDFW the upper limit is always 130%.

WATER COOLED VRF-T KXZW SYSTEM

These MHI systems use water as a source for air conditioning. They are ideal for tall buildings.

CHARACTERISTICS

- Energy savings, reduced operating costs.
- High efficiency.
- Flexible and compact design that can be transported in a lift.
- Integrates with the architecture.
- Easy transport and installation.
- BMS (Building Management System); the same system for controlling the air-cooled system (KXZ).
- Support and maintenance; easy front access to the main parts (compressor, control, plate heat exchanger, etc.).
- Wide range of control software and maintenance instruments (Mente PC, SL-Checker, etc.).

APPLICATIONS

- Ideal for applications on tall buildings.
- Skyscraper 100 metres or more in height.
- Glass façade; exterior of a building thanks to the possibility of hiding the condensing unit.





OUTDOOR UNITS ON EVERY FLOOR
(new construction projects)

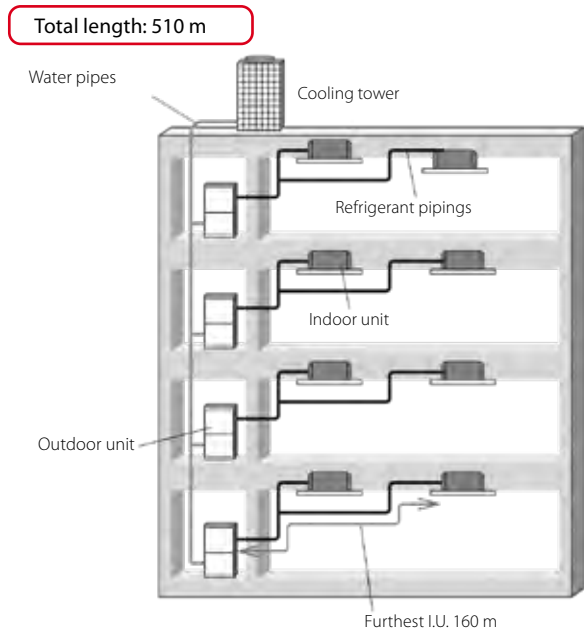

OUTDOOR ENGINE ROOM UNITS
(renovation projects)

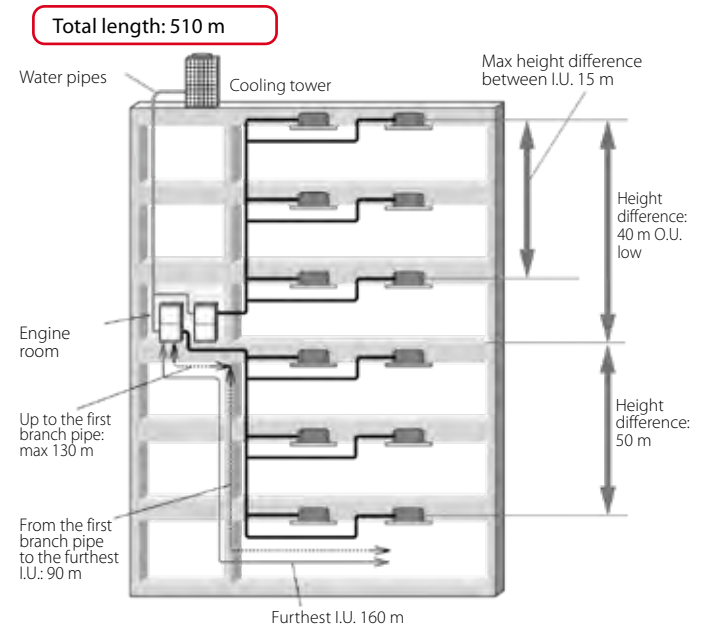

KXZW

CONNECT UP TO 33 INDOOR
UNITS/150% CAPACITY

- FDC 224 KXZWE1 22.4 kW
- FDC 280 KXZWE1 28.0 kW
- FDC 335 KXZWE1 33.5 kW



8~12HP
(22.4~33.5 kW)

Outdoor unit model			FDC 224 KXZWE1	FDC 280 KXZWE1	FDC 335 KXZWE1
Combinations			-	-	-
Power class			8	10	12
Rated capacity (W30/A27)	Cooling	kW	22.40	28.00	33.50
Rated power input (W30/A27)		kW	4.23	5.75	8.13
Rated energy efficiency coefficient		EER	5.30	4.87	4.12
Rated capacity (W20/A20)	Heating	kW	25.00	31.50	37.50
Rated power input (W20/A20)		kW	4.24	5.10	6.30
Rated energy performance coefficient		COP	5.90	6.18	5.95
Electrical data					
Power supply		Ph-V-Hz	3Ph-380~415V-50Hz		
Rated current	Cooling	A	7.14	9.64	13.40
	Heating	A	7.13	8.59	10.50
Maximum current		A	23.50	23.50	23.50
Refrigerant circuit data					
Refrigerant ¹		type (GWP)	R410A (2088)		
Q.ty of refrigerant pre-charge (tons of CO2 equivalent)		kg	9.9 (20.671)	9.9 (20.671)	9.9 (20.671)
Piping diameter ²	Liquid	inch (mm)	3/8" (9.52)	3/8" (9.52)	1/2" (12.7)
	Gas		3/4" (19.05)	7/8" (22.22)	1" (25.4)
	Oil balancing		-	-	-
Product specifications					
Dimensions	HxLxD	mm	1110x780x550	1110x780x550	1110x780x550
Net weight		kg	185	185	185
Sound power level	Max	dB(A)	65	66	66
Sound pressure level	Max	dB(A)	48	50	52
Water flow rate (for each unit)	Min ~ Max	L/min	50 ~ 150	50 ~ 150	50 ~ 150
Pressure drop of heat exchanger (for each unit)	Min ~ Max	kPa	8 ~ 68	8 ~ 68	8 ~ 68
Hydraulic pipes' diameter	In/Out	inch	R 1-1/4"	R 1-1/4"	R 1-1/4"
Operating range (inlet water temperature)	Cooling	°C	10~45	10~45	10~45
	Heating				
Connectable indoor units ³	Min ~ Max	nb.	1 ~ 22	1 ~ 28	1 ~ 33
	Capacity	%	50 ~ 150	50 ~ 150	50 ~ 150

1. Refrigerant leakage contributes to climate change. When released into the atmosphere, refrigerants with a lower global warming potential (GWP) contribute less to global warming than those with a higher GWP. This appliance contains a refrigerant with a GWP of 2088. If 1 kg of this refrigerant fluid were released into the atmosphere, therefore, the impact on global warming would be 2088 times higher than 1 kg of CO₂ over a period of 100 years. Under no circumstances should the user try to intervene on the refrigerant circuit or disassemble the product. Always contact qualified personnel if necessary. 2. The diameters indicated refer to the section up to the first junction, with an equivalent length of less than 90 m. 3. When connecting indoor units of type FDK, FDFL, FDFU or FDFW the upper limit is always 130%.

KXZW

CONNECT UP TO 67 INDOOR UNITS/150% CAPACITY

FDC 450 KXZWE1 (FDC 224x2)	45.0 kW
FDC 500 KXZWE1 (FDC 224+FDC 280)	50.0 kW
FDC 560 KXZWE1 (FDC 280x2)	56.0 kW
FDC 615 KXZWE1 (FDC 280+FDC 335)	61.5 kW
FDC 670 KXZWE1 (FDC 335x2)	67.0 kW



16~24HP
(45.0~67.0 kW)

COMBINATIONS

Outdoor unit model			FDC 450 KXZWE1	FDC 500 KXZWE1	FDC 560 KXZWE1	FDC 615 KXZWE1	FDC 670 KXZWE1	
Combinations			FDC 224 KXZWE1	FDC 224 KXZWE1	FDC 280 KXZWE1	FDC 280 KXZWE1	FDC 335 KXZWE1	
			FDC 224 KXZWE1	FDC 280KXZWE1	FDC 280 KXZWE1	FDC 335 KXZWE1	FDC 335 KXZWE1	
			-	-	-	-	-	
Power class			HP	16	18	20	22	24
Rated capacity (W30/A27)		Cooling	kW	45.00	50.00	56.00	61.50	67.00
Rated power input (W30/A27)			kW	8.49	9.83	11.50	13.70	16.30
Rated energy efficiency coefficient			EER	5.30	5.09	4.87	4.49	4.11
Rated capacity (W20/A20)		Heating	kW	50.00	56.00	63.00	69.00	75.00
Rated power input (W20/A20)			kW	8.47	9.27	10.20	11.40	12.60
Rated energy performance coefficient			COP	5.90	6.04	6.18	6.05	5.95
Electrical data								
Power supply		Ph-V-Hz	3Ph-380~415V-50Hz					
Rated current		Cooling	A	14.30	16.50	19.30	22.70	26.80
		Heating	A	14.30	15.60	17.20	19.10	21.00
Maximum current		A	47.00	47.00	47.00	47.00	47.00	47.00
Refrigerant circuit data								
Refrigerant ¹		type (GWP)	R410A (2088)					
Q.ty of refrigerant pre-charge (tons of CO2 equivalent)		kg	19.8 (41.342)	19.8 (41.342)	19.8 (41.342)	19.8 (41.342)	19.8 (41.342)	
Piping diameter ²		inch (mm)	Liquid	1/2" (12.7)	1/2" (12.7)	1/2" (12.7)	1/2" (12.7)	1/2" (12.7)
			Gas	1-1/8" (28.58)	1-1/8" (28.58)	1-1/8" (28.58)	1-1/8" (28.58)	1-1/8" (28.58)
			Oil balancing	3/8" (9.52)	3/8" (9.52)	3/8" (9.52)	3/8" (9.52)	3/8" (9.52)
Product specifications								
Dimensions		HxLxD	mm	2220x780x550	2220x780x550	2220x780x550	2220x780x550	2220x780x550
Net weight		kg	370	370	370	370	370	
Sound power level		Max	dB(A)	-	-	-	-	-
Sound pressure level		Max	dB(A)	51	52	53	54	55
Water flow rate (for each unit)		Min ~ Max	L/min	50 ~ 150	50 ~ 150	50 ~ 150	50 ~ 150	50 ~ 150
Pressure drop of heat exchanger (for each unit)		Min ~ Max	kPa	8 ~ 68	8 ~ 68	8 ~ 68	8 ~ 68	8 ~ 68
Hydraulic pipes' diameter		In/Out	inch	R 1-1/4"	R 1-1/4"	R 1-1/4"	R 1-1/4"	R 1-1/4"
Operating range (inlet water temperature)		Cooling	°C	10~45	10~45	10~45	10~45	10~45
		Heating	°C	10~45	10~45	10~45	10~45	10~45
Connectable indoor units ³		Min ~ Max	nb.	1 ~ 44	1 ~ 50	1 ~ 56	2 ~ 61	2 ~ 67
		Capacity	%	50 ~ 150	50 ~ 150	50 ~ 150	50 ~ 150	50 ~ 150

1. Refrigerant leakage contributes to climate change. When released into the atmosphere, refrigerants with a lower global warming potential (GWP) contribute less to global warming than those with a higher GWP. This appliance contains a refrigerant with a GWP of 2088. If 1 kg of this refrigerant fluid were released into the atmosphere, therefore, the impact on global warming would be 2088 times higher than 1 kg of CO₂ over a period of 100 years. Under no circumstances should the user try to intervene on the refrigerant circuit or disassemble the product. Always contact qualified personnel if necessary. 2. The diameters indicated refer to the section up to the first junction, with an equivalent length of less than 90 m. 3. When connecting indoor units of type FDK, FDFL, FDFU or FDFW the upper limit is always 130%.

KXZW

CONNECT UP TO 80 INDOOR
UNITS/150% CAPACITY

FDC 730 KXZWE1 (FDC 224x2+FDC 280)	73.0 kW
FDC 775 KXZWE1 (FDC 224+FDC 280x2)	77.5 kW
FDC 850 KXZWE1 (FDC 280x3)	85.0 kW
FDC 900 KXZWE1 (FDC 280x2+FDC 335)	90.0 kW
FDC 950 KXZWE1 (FDC 280+FDC 335x2)	95.0 kW
FDC 1000 KXZWE1 (FDC 335x3)	100.0 kW



26~36HP
(73.0~100.0 kW)

COMBINATIONS

Outdoor unit model			FDC 730 KXZWE1	FDC 775 KXZWE1	FDC 850 KXZWE1	FDC 900 KXZWE1	FDC 950 KXZWE1	FDC 1000 KXZWE1		
Combinations			FDC 224 KXZWE1	FDC 224 KXZWE1	FDC 280 KXZWE1	FDC 280 KXZWE1	FDC 280 KXZWE1	FDC 335 KXZWE1		
			FDC 224 KXZWE1	FDC 280 KXZWE1	FDC 280 KXZWE1	FDC 280 KXZWE1	FDC 335 KXZWE1	FDC 335 KXZWE1		
			FDC 280KXZWE1	FDC280 KXZWE1	FDC 280 KXZWE1	FDC 335 KXZWE1	FDC 335 KXZWE1	FDC 335 KXZWE1		
Power class			HP	26	28	30	32	34	36	
Rated capacity (W30/A27)			kW	73.00	77.50	85.00	90.00	95.00	100.00	
Rated power input (W30/A27)			Cooling	kW	14.20	15.50	17.50	19.50	21.70	24.30
Rated energy efficiency coefficient				EER	5.14	5.00	4.86	4.62	4.38	4.12
Rated capacity (W20/A20)				kW	82.50	90.00	95.00	100.00	106.00	112.00
Rated power input (W20/A20)			Heating	kW	13.80	14.80	15.40	16.40	17.60	18.80
Rated energy performance coefficient				COP	5.98	6.08	6.17	6.10	6.02	5.96
Electrical data										
Power supply			Ph-V-Hz	3Ph-380~415V-50Hz						
Rated current			Cooling	A	23.80	26.00	29.30	32.50	36.00	40.00
				Heating	A	23.20	24.90	25.90	27.50	29.40
Maximum current			A	70.50	70.50	70.50	70.50	70.50	70.50	
Refrigerant circuit data										
Refrigerant ¹			type (GWP)	R410A (2088)						
Q.ty of refrigerant pre-charge (tons of CO2 equivalent)			kg	29.7 (62.014)	29.7 (62.014)	29.7 (62.014)	29.7 (62.014)	29.7 (62.014)	29.7 (62.014)	
Piping diameter ²			inch (mm)	Liquid	5/8" (15.88)	5/8" (15.88)	5/8" (15.88)	5/8" (15.88)	5/8" (15.88)	5/8" (15.88)
				Gas	1-1/4" (31.75)	1-1/4" (31.75)	1-1/4" (31.75)	1-1/4" (31.75)	1-1/4" (31.75)	1-1/2" (38.1)
Oil balancing					3/8" (9.52)	3/8" (9.52)	3/8" (9.52)	3/8" (9.52)	3/8" (9.52)	3/8" (9.52)
Product specifications										
Dimensions			HxLxD	mm	3330x780X550	3330x780X550	3330x780X550	3330x780X550	3330x780X550	
Net weight			kg	555	555	555	555	555	555	
Sound power level			Max	dB(A)	-	-	-	-	-	
Sound pressure level			Max	dB(A)	54	54	55	56	56	57
Water flow rate (for each unit)			Min ~ Max	L/min	50 ~ 150	50 ~ 150	50 ~ 150	50 ~ 150	50 ~ 150	50 ~ 150
Pressure drop of heat exchanger (for each unit)			Min ~ Max	kPa	8 ~ 68	8 ~ 68	8 ~ 68	8 ~ 68	8 ~ 68	8 ~ 68
Hydraulic pipes' diameter			In/Out	inch	R 1-1/4"	R 1-1/4"	R 1-1/4"	R 1-1/4"	R 1-1/4"	R 1-1/4"
Operating range (inlet water temperature)			Cooling	°C	10~45	10~45	10~45	10~45	10~45	10~45
					Heating	nb.	2 ~ 72	2 ~ 78	2 ~ 80	2 ~ 80
Connectable indoor units ³			Min ~ Max	nb.		2 ~ 72	2 ~ 78	2 ~ 80	2 ~ 80	2 ~ 80
			Capacity	%	50 ~ 150	50 ~ 150	50 ~ 150	50 ~ 150	50 ~ 150	

1. Refrigerant leakage contributes to climate change. When released into the atmosphere, refrigerants with a lower global warming potential (GWP) contribute less to global warming than those with a higher GWP. This appliance contains a refrigerant with a GWP of 2088. If 1 kg of this refrigerant fluid were released into the atmosphere, therefore, the impact on global warming would be 2088 times higher than 1 kg of CO2, over a period of 100 years. Under no circumstances should the user try to intervene on the refrigerant circuit or disassemble the product. Always contact qualified personnel if necessary. 2. The diameters indicated refer to the section up to the first junction, with an equivalent length of less than 90 m. 3. When connecting indoor units of type FDK, FDFL, FDFU or FDFW the upper limit is always 130%.







INDOOR UNITS

		HP kW	0.5 1.5	0.8 2.2	1 2.8	1.25 3.6	1.6 4.5	2 5.6	2.5 7.1	3.2 9.0	4 11.2	6 14.0	6 16.0	8 22.4	10 28.0
Cassette	84x84  FDT				✓	✓	✓	✓	✓	✓	✓	✓	✓		
	60x60 compact  FDTc	✓	✓	✓	✓	✓	✓								
	2-way  FDTw			✓			✓	✓	✓	✓	✓	✓			
	1-way  FDTs						✓		✓						
	1-way ducted compact  FDTq		✓	✓	✓										
Ducted	high static pressure adjustable  FDU						✓	✓	✓	✓	✓	✓	✓	✓	✓
	medium and low static pressure adjustable  FDUM		✓	✓	✓	✓	✓	✓	✓	✓	✓	✓			
	all-outside air  FDUF									✓		✓		✓	✓
	ducted low static pressure  FDUT	✓	✓	✓	✓	✓	✓	✓	✓						
	compact  FDUH		✓	✓	✓										
Wall  FDK	✓	✓	✓	✓	✓	✓	✓	✓	✓						
Ceiling  FDE					✓	✓	✓	✓		✓	✓				
Floor	Console  FDW			✓		✓	✓								
	recessed  FDU			✓		✓	✓	✓							

ENTHALPY HEAT RECOVERY UNIT

	150	250	350	500	800	1000
	✓	✓	✓	✓	✓	✓

POST-TREATMENT MODULAR UNIT

	250	350	500	800	1000
	✓	✓	✓	✓	✓

MOTION SENSOR HUMAN SENSOR

MODELS ON WHICH THE SENSOR CAN BE INSTALLED



ENERGY SAVINGS THROUGH MOTION DETECTION IN THE ROOM

The HUMAN SENSOR detects the presence/absence and/or movement of persons in the room to improve comfort and performance, thanks to the unit's energy saving functions.

3 ENERGY SAVING CONTROL MODE

1. POWER CONTROL

The new motion sensor detects human activity in the room. Energy saving control is obtained by modifying the set temperature based on the amount and type of detected activity.

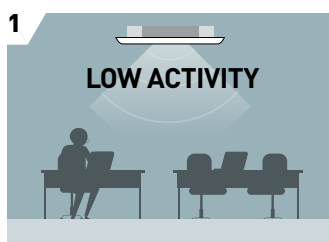

Power control increases energy saving.



Power control increases comfort.

2. AUTO-OFF: STAND BY

The unit stops running if no activity is detected for 1 hour. It re-starts automatically when activity is detected.

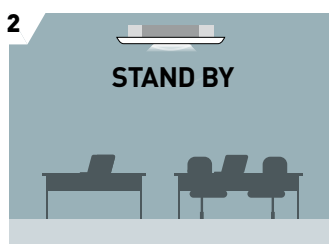

Operation shuts off temporarily.

3. AUTO-OFF: TOTAL SHUT-DOWN

The unit shuts down automatically if no activity is detected for 12 hours.

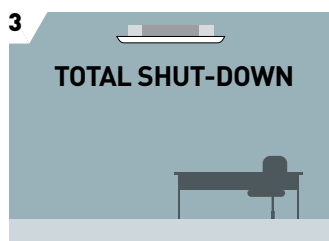

Operation shuts off completely.

INDOOR UNITS

CASSETTE 84x84

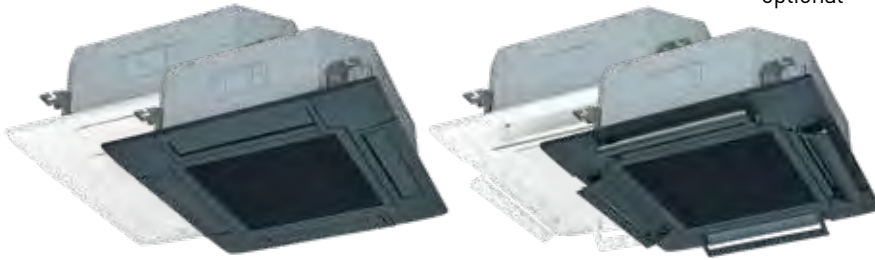

9 capacities

(2.80-16.00 kW)

- Ideal for residential and commercial applications: the cassette becomes invisible because it is completely built into the false ceiling
- Removable caps on the 4 corners for easy installation
- Easy condensate drain pan control
- Anti-draft panel: flexible flap control for FDT (optional)
- Corner with "Human Sensor":
 - LB-T-5BW-E white
 - LB-T-5BB-E black
- Condensate drain pump as standard: raises condensation up to 850 mm from the flush panel

FDT 28~160 KXZE1

- Standard T-PSA-5BW-E panel
- Standard T-PSA-5BB-E panel

FDT 28~160 KXZE1

- Antidraft T-PSAE-5BW-E panel
- Antidraft T-PSAE-5BB-E panel

ANTIDRAFT PANEL

Maximum comfort without direct drafts: new flap control for greater flexibility.

Model		FDT 28 KXZE1	FDT 36 KXZE1	FDT 45 KXZE1	FDT 56 KXZE1	FDT 71 KXZE1	FDT 90 KXZE1	FDT 112 KXZE1	FDT 140 KXZE1	FDT 160 KXZE1	
Standard white / black panel		T-PSA-5BW-E / T-PSA-5BB-E									
Antidraft white / black panel		T-PSAE-5BW-E / T-PSAE-5BB-E									
Rated capacity (Cooling)	kW	2.80	3.60	4.50	5.60	7.10	9.00	11.20	14.00	16.00	
Rated capacity (Heating)	kW	3.20	4.00	5.00	6.30	8.00	10.00	12.50	16.00	18.00	
Power supply		220-240V~ 50Hz									
Power input (Cooling)	kW	0.02 - 0.02	0.03 - 0.03	0.03 - 0.03	0.04 - 0.04	0.08 - 0.08	0.13 - 0.13	0.14 - 0.14	0.14 - 0.14	0.14 - 0.14	
Power input (Heating)	kW	0.02 - 0.02	0.03 - 0.03	0.03 - 0.03	0.04 - 0.04	0.08 - 0.08	0.13 - 0.13	0.14 - 0.14	0.14 - 0.14	0.14 - 0.14	
Rated current (Cooling)	A	0.20 - 0.19	0.30 - 0.28	0.30 - 0.28	0.36 - 0.33	0.70 - 0.64	1.04 - 0.95	1.12 - 1.02	1.12 - 1.02	1.12 - 1.02	
Rated current (Heating)	A	0.20 - 0.19	0.30 - 0.28	0.30 - 0.28	0.36 - 0.33	0.70 - 0.64	1.04 - 0.95	1.12 - 1.02	1.12 - 1.02	1.12 - 1.02	
Sound pressure level	dB(A)	P-Hi 33 Hi 31 Me 29 Lo 27	P-Hi 34 Hi 31 Me 29 Lo 27	P-Hi 35 Hi 33 Me 31 Lo 27	P-Hi 38 Hi 33 Me 31 Lo 27	P-Hi 47 Hi 35 Me 32 Lo 28	P-Hi 49 Hi 38 Me 36 Lo 31	P-Hi 49 Hi 39 Me 37 Lo 31	P-Hi 49 Hi 42 Me 39 Lo 32	P-Hi 49 Hi 42 Me 39 Lo 33	
Sound power level	dB(A)	49	49	50	55	62	65	66	66	66	
External dimensions (HxLxD)		Unit 236 x 840 x 840					Unit 298 x 840 x 840				
External appearance		Snow white (RAL 9003). Shadow black (RAL 7022)									
Munsell color		(8.0Y9.3 / 0.1). (7.2BG2.9 / 0.6)									
Net weight		Unit 20 Panel 5			Unit 21.5 Panel 5			Unit 25 Panel 5			
Refrigerant circuit/Heat exchanger		Finned and internally grooved pipes									
Refrigerant control		Electronic expansion valve									
Air treatment/fan type & quantity		Turbo fan x 1									
Motor	W	58	58	58	58	58	120	120	120	120	
Starting method		Direct, in line									
Air flow (standard)	m ³ /h	PHi 900 Hi 840 Me 720 Lo 600	PHi 960 Hi 840 Me 720 Lo 600	PHi 1020 Hi 900 Me 780 Lo 600	PHi 1200 Hi 960 Me 780 Lo 660	PHi 1680 Hi 1020 Me 840 Lo 720	PHi 2220 Hi 1500 Me 1320 Lo 900	PHi 2280 Hi 1560 Me 1380 Lo 1020	PHi 2280 Hi 1680 Me 1500 Lo 1080	PHi 2280 Hi 1740 Me 1560 Lo 1140	
Static pressure	Pa	0									
Fresh air inlet		Possible									
Air filter & quantity		Plastic mesh filter x 1 (washable)									
Shock & vibration absorption		Rubber vibration absorber (for fan motor)									
Thermal & acoustic insulation		Polyurethane foam									
Optional control devices		Wired control RC-E5; Wired control RCH-E3; Wired control RC-EX3A; Remote control kit RCN-T-5BW-E2 (white); Remote control kit RCN-T-5BB-E2 (black)									
Ambient temperature control		Electronically-controlled thermostat									
Safety devices		Overvoltage protection for the fan motor Anti-frost protection thermostat									
Refrigerant pipings' diameter	mm (in)	Liquid side: Ø6.35 (1/4") Gas side: Ø9.52 (3/8")									
Joining method		flare									
Refrigerant		R410A									
Drain pump		Built-in									
Condensate drain		Can be connected with VP25									
Piping insulation		Necessary (on both sides, Liquid & Gas)									
Accessories included		Assembly kit, Condensate pipe									
Wi-Fi module (optional)		INWFMHI001R100									

INDOOR UNITS

CASSETTE 60x60



FDTC 15-56 KXZE1
Linear standard panel
TC-PSAG-5AW-E



FDTC 15-56 KXZE1
Anti-draft honeycomb panel
TC-PSAE-5AW-E

6 capacities

(1.50-5.60 kW)

- Ideal for residential and commercial applications: the cassette becomes invisible because it is completely built into the false ceiling
- Removable caps on the 4 corners for easy installation
- Individual louver movement control
- Anti-draft panel: flexible flap control FDTC (optional)
- Corner with "Human Sensor": LB-TC-5W-E
- Condensate drain pump as standard: raises condensation up to 850 mm from the flush panel

ANTIDRAFT PANEL

Maximum comfort without direct drafts: new flap control for greater flexibility.

Model		FDTC 15 KXZE1	FDTC 22 KXZE1	FDTC 28 KXZE1	FDTC 36 KXZE1	FDTC 45 KXZE1	FDTC 56 KXZE1
Standard honeycomb/linear panel		TC-PSA-5AW-E / TC-PSAG-5AW-E					
Anti-draft honeycomb / linear panel		TC-PSAE-5AW-E / TC-PSAGE-5AW-E					
Rated capacity (Cooling)	kW	1.50	2.20	2.80	3.60	4.50	5.60
Rated capacity (Heating)	kW	1.70	2.50	3.20	4.00	5.00	6.30
Power supply		220-240V~ 50Hz					
Power input (Cooling)	kW	0.03 - 0.03	0.03 - 0.03	0.03 - 0.03	0.04 - 0.04	0.05 - 0.05	0.06 - 0.06
Power input (Heating)	kW	0.03 - 0.03	0.03 - 0.03	0.03 - 0.03	0.04 - 0.04	0.05 - 0.05	0.06 - 0.06
Rated current (Cooling)	A	0.25 - 0.25	0.25 - 0.25	0.25 - 0.25	0.38 - 0.38	0.43 - 0.43	0.54 - 0.54
Rated current (Heating)	A	0.25 - 0.25	0.25 - 0.25	0.25 - 0.25	0.38 - 0.38	0.43 - 0.43	0.54 - 0.54
Sound pressure level	dB(A)	Hi 30 Me 28 Lo 25	Hi 32 Me 29 Lo 25	Hi 32 Me 29 Lo 25	Hi 36 Me 31 Lo 26	Hi 39 Me 36 Lo 28	Hi 43 Me 39 Lo 31
Sound power level	dB(A)	47	49	49	54	58	60
External dimensions (HxLxD)	mm	Unit 248 x 570 x 570 Panel 10 x 620 x 620					
External appearance		Snow white (RAL 9003)					
Munsell color		(8.0Y9.3 / 0.1) similar					
Net weight	kg	Unit 12.5 Panel 2.5	Unit 13 Panel 2.5			Unit 14 Panel 2.5	
Refrigerant circuit/Heat exchanger		Finned and internally grooved pipes					
Refrigerant control		Electronic expansion valve					
Air treatment/fan type & quantity		Turbo fan x 1					
Motor	W	50					
Starting method		Direct, in line					
Air flow (standard)	m ³ /h	Hi 420 Me 360 Lo 300	Hi 480 Me 420 Lo 360	Hi 480 Me 420 Lo 360	Hi 540 Me 480 Lo 360	Hi 600 Me 540 Lo 420	Hi 720 Me 600 Lo 480
Static pressure	Pa	0					
Fresh air inlet		Possible with accessories					
Air filter & quantity		Plastic mesh filter x 1 (washable)					
Shock & vibration absorption		Rubber vibration absorber (for fan motor)					
Thermal & acoustic insulation		Polyurethane foam					
Optional control devices		Wired control RC-E5; Wired control RCH-E3; Wired control RC-EX3A; Remote control kit RCN-TC-5AW-E3					
Ambient temperature control		Electronically-controlled thermostat					
Safety devices		Overvoltage protection for the fan motor					
		Anti-frost protection thermostat					
Refrigerant pipings' diameter	mm (in)	Gas side: Ø9.52 (3/8")			Liquid side: Ø6.35 (1/4")		Gas side: Ø12.7 (1/2")
Joining method		flare					
Refrigerant		R410A					
Drain pump		Built-in					
Condensate drain		Can be connected with VP25					
Piping insulation		Necessary (on both sides, Liquid & Gas)					
Accessories		Assembly kit; TC-OAS-E2 (Optional); TC-OAD-E (Optional)					
Wi-Fi module (optional)		INWFIMH001R100					



FDTC 15-56 KXZE1
Standard honeycomb panel
TC-PSA-5AW-E



FDTC 15-56 KXZE1
Linear anti-draft panel
TC-PSAGE-5AW-E

2 TYPES OF GRILLES

Possibility of choosing between honeycomb grille and linear grille.

INDOOR UNITS

2-WAY CASSETTE



■ 7 capacities (2.80~14.00 kW)

- Can be fully built in to the false ceiling, enabling uniform air distribution in environments with a rectangular perimeter
- Panels: TW-PSA-26W-E (Models FDTW 28/45/56/71 KXE6F); TW-PSA-46W-E (Models FDTW 90/112/140 KXE6F)
- "Human sensor": LB-TW-6W

FDTW 28~140 KXE6F

CONDENSATE DRAIN PUMP

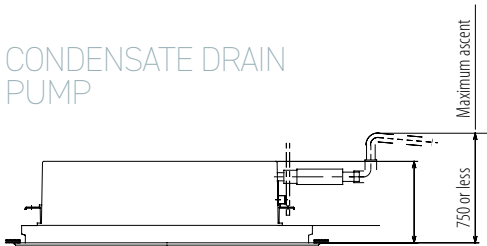

INDIVIDUAL CONTROL OF AIR OUTLET FLAPS

The new design of the flaps ensures uniform, wide-ranging air distribution throughout the area to be conditioned. The enlargement of the delivery vents has significantly reduced the load on the fan motor, resulting in increased energy efficiency.

Model		FDTW 28 KXE6F	FDTW 45 KXE6F	FDTW 56 KXE6F	FDTW 71 KXE6F	FDTW 90 KXE6F	FDTW 112 KXE6F	FDTW 140 KXE6F	
Panel (optional)		TW-PSA-26W-E	TW-PSA-26W-E	TW-PSA-26W-E	TW-PSA-26W-E	TW-PSA-46W-E	TW-PSA-46W-E	TW-PSA-46W-E	
Rated capacity (Cooling)	kW	2.80	4.50	5.60	7.10	9.00	11.20	14.00	
Rated capacity (Heating)	kW	3.20	5.00	6.30	8.00	10.00	12.50	16.00	
Power supply		220-240V~ 50Hz							
Power input (Cooling)	kW	0.09 - 0.09	0.10 - 0.10	0.10 - 0.10	0.14 - 0.14	0.19 - 0.19	0.19 - 0.19	0.19 - 0.19	
Power input (Heating)	kW	0.09 - 0.09	0.10 - 0.10	0.10 - 0.10	0.14 - 0.14	0.19 - 0.19	0.19 - 0.19	0.19 - 0.19	
Rated current (Cooling)	A	0.45 - 0.45	0.55 - 0.55	0.55 - 0.55	0.75 - 0.75	1.00 - 1.00	1.00 - 1.00	1.00 - 1.00	
Rated current (Heating)	A	0.45 - 0.45	0.55 - 0.55	0.55 - 0.55	0.75 - 0.75	1.00 - 1.00	1.00 - 1.00	1.00 - 1.00	
Sound pressure level	dB(A)	Hi 38 Me 34 Lo 31	Hi 38 Me 34 Lo 31	Hi 38 Me 34 Lo 31	Hi 38 Me 34 Lo 31	Hi 45 Me 41 Lo 37	Hi 45 Me 41 Lo 37	Hi 45 Me 41 Lo 37	
Sound power level	dB(A)	58	58	58	58	65	65	65	
External dimensions (HxLxD)	mm	Unit 325 x 820 x 620 Panel 20 x 1.120 x 680			Unit 325 x 1.535 x 620 Panel 20 x 1.835 x 680				
External appearance		Chalk white							
Munsell color		(6.8Y8.9 / 0.2) similar							
Net weight	kg	Unit 20 Panel 8.5	Unit 21 Panel 8.5		Unit 23 Panel 8.5	Unit 35 Panel 13			
Refrigerant circuit/Heat exchanger		Finned and internally grooved pipes							
Refrigerant control		Electronic expansion valve							
Air treatment/fan type & quantity		Turbo fan x 1				Turbo fan x 2			
Motor	W	30	35	35	40	35 x 2			
Starting method		Direct, in line							
Air flow (standard)	m ³ /h	Hi 720 Me 600 Lo 540				Hi 1620 Me 1380 Lo 1200			
Static pressure	Pa	0							
Fresh air inlet		Possible							
Air filter & quantity		Plastic mesh filter x 1 (washable)							
Shock & vibration absorption		Rubber sleeve (for fan motor)							
Thermal & acoustic insulation		Polyurethane foam							
Control devices		Optional Wired control RC-E5; optional RCH-E3; optional RCN-TW-E2; optional RC-EX3							
Ambient temperature control		Electronically-controlled thermostat							
Safety devices		Overvoltage protection for the fan motor Anti-frost protection thermostat							
Refrigerant pipings' diameter	mm (in)	Liquid side Ø6.35 (1/4") Gas side Ø9.52 (3/8")			Liquid side Ø6.35 (1/4") Gas side Ø12.7 (1/2")		Liquid side Ø9.52 (3/8") Gas side Ø15.88 (5/8")		
Joining method		flare							
Refrigerant		R410A							
Drain pump		Built-in							
Condensate drain		Can be connected with VP25							
Piping insulation		Necessary (on both sides, Liquid & Gas)							
Accessories		Assembly kit							

INDOOR UNITS

1-WAY CASSETTE



■ 2 capacities

(4.50 and 7.10 kW)

- Can be mounted on the ceiling with a suspended unit or built into the false ceiling
- Maximum compactness: only 22 cm high, ideal for installations in environments with low false ceilings
- Wide air flow, ideal for environments with very high ceilings
- Possibility to connect air renewal ducts
- Panel: TS-PSA-3AW-E
- "Human sensor": LB-KIT2

FDTS 45-71KXE6F

ULTRA-COMPACT MODEL



Ultra-compact design: its height of only 22 cm and weight of 27/28 kg guarantee easy and quick installation.

INDIVIDUAL CONTROL OF AIR OUTLET FLAPS



The new design of the louvers ensures uniform, wide-ranging air distribution throughout the area to be conditioned. The enlargement of the delivery vents has significantly reduced the load on the fan motor, resulting in increased energy efficiency.

Model		FDTS 45 KXE6F	FDTS 71 KXE6F
Panel (optional)		TS-PSA-3AW-E	TS-PSA-3AW-E
Rated capacity (Cooling)	kW	4.50	7.10
Rated capacity (Heating)	kW	5.00	8.00
Power supply		220-240V ~ 50Hz	
Power input (Cooling)	kW	0.04 - 0.04	0.09 - 0.09
Power input (Heating)	kW	0.04 - 0.04	0.09 - 0.09
Rated current (Cooling)	A	0.27 - 0.25	0.60 - 0.55
Rated current (Heating)	A	0.27 - 0.25	0.60 - 0.55
Sound pressure level	dB(A)	Hi 40 Me 38 Lo 35	Hi 44 Me 41 Lo 36
Sound power level	dB(A)	60	61
External dimensions (HxLxD)	mm	Unit 220 x 1.150 x 565 Panel 35 x 1.250 x 650	
External appearance		Chalk white	
Munsell color		(6.8Y8.9 / 0.2) similar	
Net weight	kg	unit 27 Panel 5	Unit 28 Panel 5
Refrigerant circuit/Heat exchanger		Finned and internally grooved pipes	
Refrigerant control		Electronic expansion valve	
Air treatment/fan type & quantity		Centrifugal fan x 4	
Motor	W	35	70
Starting method		Direct, in line	Direct, in line
Air flow (standard)	m³/h	Hi 720 Me 660 Lo 570	Hi 900 Me 720 Lo 600
Static pressure	Pa	0	
Fresh air inlet		Possible	
Filtro aria e quantità		Plastic mesh filter x 2 (washable)	Plastic mesh filter x 3 (washable)
Shock & vibration absorption		Rubber vibration absorber (for fan motor)	
Thermal & acoustic insulation		Polyurethane foam	
Control devices		Optional Wired control RC-E5; optional RCH-E3; optional RCN-TS-E2; optional RC-EX3	
Ambient temperature control		Electronically-controlled thermostat	
Safety devices		Overvoltage protection for the fan motor Anti-frost protection thermostat	
Refrigerant pipings' diameter	mm (in)	Liquid side Ø6.35 (1/4") Gas side Ø12.7 (1/2")	Liquid side Ø9.52 (3/8") Gas side Ø15.88 (5/8")
Joining method		flare	
Refrigerant		R410A	
Drain pump		Built-in	
Condensate drain		Can be connected with VP25	
Piping insulation		Necessary (on both sides, Liquid & Gas)	
Accessories		Assembly kit	

INDOOR UNITS

1-WAY COMPACT DUCTED CASSETTE

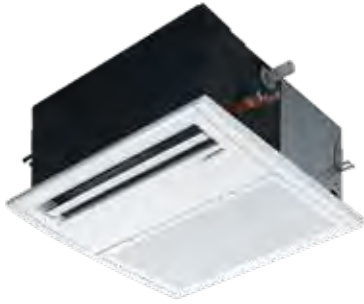

■ 3 capacities (2.20~3.60 kW)

- Ideal for smaller environments, with a fan speed of only 300 m³/h
- Panel with direct delivery
- Panel equipped with motorised louvre for comfortable air flow distribution
- Condensate drain pump as standard h 60 cm

FDTQ 22~36 KXE6F

ULTRA-COMPACT MODEL

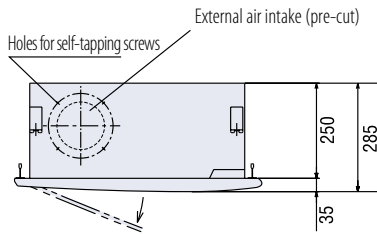

STANDARD CONDENSATE DRAIN PUMP

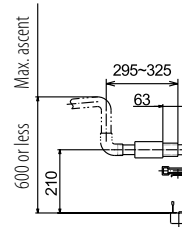

Model		FDTQ 22 KXE6F	FDTQ 28 KXE6F	FDTQ 36 KXE6F
Panel (optional)		Direct delivery TQ-PSA-15W-E	Direct delivery TQ-PSA-15W-E	Direct delivery TQ-PSA-15W-E
Rated capacity (Cooling)	kW	2.20	2.80	3.60
Rated capacity (Heating)	kW	2.50	3.20	4.00
Power supply		220-240V ~ 50Hz		
Power input (Cooling)	kW	0.05 - 0.07	0.05 - 0.07	0.05 - 0.07
Power input (Heating)	kW	0.05 - 0.07	0.05 - 0.07	0.05 - 0.07
Starting current (Cooling)	A	0.25 - 0.32	0.25 - 0.32	0.25 - 0.32
Starting current (Heating)	A	0.25 - 0.32	0.25 - 0.32	0.25 - 0.32
Sound pressure level	dB(A)	Hi 41 Me 38 Lo 33	Hi 41 Me 38 Lo 33	Hi 41 Me 38 Lo 33
Sound power level	dB(A)	60	60	60
External dimensions (HxLxD)	mm	Unit 250 x 570 x 570 Panel 35 x 625 x 650		
External appearance		Chalk white		
Munsell color		(6.8Y8.9 / 0.2) similar		
Net weight	kg	Unit 23 Panel 2.5		
Refrigerant circuit/Heat exchanger		Finned and internally grooved pipes		
Refrigerant control		Electronic expansion valve		
Air treatment/fan type & quantity		Centrifugal fan x 1		
Motor	W	30	30	30
Starting method		Direct, in line		
Air flow (standard)	m ³ /h	Hi 420 Me 360 Lo 300	Hi 420 Me 360 Lo 300	Hi 420 Me 360 Lo 300
Static pressure	Pa	0		
Fresh air inlet		Possible		
Air filter & quantity		Plastic mesh filter x 1 (washable)		
Shock & vibration absorption		Rubber vibration absorber (for fan motor)		
Thermal & acoustic insulation		Polyurethane foam		
Control devices		Optional Wired control RC-E5; optional RCH-E3; optional RCN-KIT4-E2; optional RC-EX3		
Ambient temperature control		Electronically-controlled thermostat		
Safety devices		Overvoltage protection for the fan motor Anti-frost protection thermostat		
Refrigerant pipings' diameter	mm (in)	Gas side: Ø9.52 (3/8")		Gas side: Ø12.7 (1/2")
Joining method		flare		
Refrigerant		R410A		
Drain pump		Built-in		
Condensate drain		Can be connected with VP20		
Piping insulation		Necessary (on both sides, Liquid & Gas)		
Accessories		Assembly kit		

INDOOR UNITS

DUCTED HIGH STATIC PRESSURE ADJUSTABLE



WiFi optional

FDU 45~160 KXE6F

FDU 224~280 KXZE1

■ 9 capacities

(4.50~28.00 kW)

- Units with rear recovery
- Adjustable static pressure 100~200 Pa for the models from 4.50 to 16.00 kW and only 200 Pa for the models from 22.40 to 28.00 kW
- Maximum compactness: only 28 cm (models from 4.50 to 16.00 kW) and 37.9 cm high (22.40 and 28.00 kW models)
- Integrated condensate drain pump for models from 4.50 to 16.00 kW
- "Human sensor": LB-KIT2

COMPACT SIZE

280 mm



Models from 4.50 to 16.00 kW



Models from 22.40 to 28.00 kW

Model		FDU 45 KXE6F	FDU 56 KXE6F	FDU 71 KXE6F	FDU 90 KXE6F	FDU 112 KXE6F	FDU 140 KXE6F	FDU 160 KXE6F	FDU 224 KXZE1	FDU 280 KXZE1	
Rated capacity (Cooling)	kW	4.50	5.60	7.10	9.00	11.20	14.00	16.00	22.40	28.00	
Rated capacity (Heating)	kW	5.00	6.30	8.00	10.00	12.50	16.00	18.00	25.00	31.50	
Power supply		220-240V~50Hz									
Power input (Cooling)	kW	0.10 - 0.10	0.10 - 0.10	0.24 - 0.25	0.24 - 0.25	0.31 - 0.32	0.35 - 0.36	0.42 - 0.43	1.16 - 1.20	1.16 - 1.20	
Power input (Heating)	kW	0.10 - 0.10	0.10 - 0.10	0.24 - 0.25	0.24 - 0.25	0.31 - 0.32	0.35 - 0.36	0.42 - 0.43	1.16 - 1.20	1.16 - 1.20	
Rated current (Cooling)	A	0.63 - 0.58	0.63 - 0.58	1.80 - 1.70	1.80 - 1.70	2.00 - 2.00	2.30 - 2.20	2.70 - 2.50	6.80 - 6.50	6.80 - 6.50	
Rated current (Heating)	A	0.63 - 0.58	0.63 - 0.58	1.80 - 1.70	1.80 - 1.70	2.00 - 2.00	2.30 - 2.20	2.70 - 2.50	6.80 - 6.50	6.80 - 6.50	
Sound pressure level	dB(A)	Hi 32 Med 29 Lo 26		Hi 33 Med 29 Lo 25		Hi 38 Med 36 Lo 30		Hi 40 Med 34 Lo 29		Hi 40 Med 35 Lo 30	
Sound power level	dB(A)	60		65		71		72		74	
External dimensions (HxLxD)	mm	280x750x635		280x950x635		280x1.370x740			379x1.600x893		
Net weight	kg	29		34		54			89		
Refrigerant circuit/Heat exchanger		Finned and internally grooved pipes									
Refrigerant control		Electronic expansion valve									
Air treatment/fan type & quantity		Centrifugal fan x 1									
Motor	W	100		130		100 + 130		100 + 200		130 + 350	
Starting method		Direct, in line									
Air flow (standard)	m ³ /h	Hi 600 Med 540 Lo 480		Hi 1140 Med 900 Lo 600		Hi 1680 Med 1500 Lo 1140		Hi 1920 Med 1560 Lo 1200		Hi 2100 Med 1680 Lo 1320	
Static pressure	Pa	Standard 100 Max 200								Max 200	
Fresh air inlet		Possible									
Air filter & quantity		To be found locally									
Shock & vibration absorption		Rubber vibration absorber (for fan motor)									
Thermal & acoustic insulation		Polyurethane foam									
Control devices		Optional Wired control RC-E5; optional RCH-E3; optional RCN-KIT4-E2; optional RC-EX3									
Ambient temperature control		Electronically-controlled thermostat									
Safety devices		Overvoltage protection for the fan motor									
		Anti-frost protection thermostat									
Refrigerant pipings' diameter	mm (in)	Liquid side: Ø6.35 (1/4")						Liquid side Ø9.52 (3/8")		Gas side Ø19.05 (3/4") Gas side Ø22.2 (7/8")	
Joining method		Flare								To weld	
Refrigerant		R410A									
Drain pump		Built-in									
Condensate drain		Can be connected with VP25									
Piping insulation		Necessary (on both sides, Liquid & Gas)									
Accessories		-									

INDOOR UNITS

DUCTED MEDIUM AND LOW STATIC PRESSURE ADJUSTABLE



WiFi optional

■ 10 capacities

(2.20~16.00 kW)

- Ultra-compact design: only 28 cm in height
- Optional filter kit UM-FL1EF (FDUM 22~56 KXE6F), UM-FL2EF (FDUM 71~90 KXE6F), UM-FL3EF (FDUM 112~160 KXE6F)
- ESP function: automatic maintenance of the air flow rate as flow resistance varies
- "Human sensor": LB-KIT2

FDUM 22~160 KXE6F

COMPACT SIZE

280 mm



For all models

Model		FDUM 22 KXE6F	FDUM 28 KXE6F	FDUM 36 KXE6F	FDUM 45 KXE6F	FDUM 56 KXE6F	FDUM 71 KXE6F	FDUM 90 KXE6F	FDUM 112 KXE6F	FDUM 140 KXE6F	FDUM 160 KXE6F		
Rated capacity (Cooling)	kW	2.20	2.80	3.60	4.50	5.60	7.10	9.00	11.20	14.00	16.00		
Rated capacity (Heating)	kW	2.50	3.20	4.00	5.00	6.30	8.00	10.00	12.50	16.00	18.00		
Power supply		220-240V~50Hz											
Power input (Cooling)	kW	0.10 - 0.10	0.10 - 0.10	0.10 - 0.10	0.10 - 0.10	0.10 - 0.10	0.20 - 0.20	0.20 - 0.20	0.29 - 0.29	0.33 - 0.33	0.33 - 0.33		
Power input (Heating)	kW	0.10 - 0.10	0.10 - 0.10	0.10 - 0.10	0.10 - 0.10	0.10 - 0.10	0.20 - 0.20	0.20 - 0.20	0.29 - 0.29	0.33 - 0.33	0.33 - 0.33		
Rated current (Cooling)	A	0.46 - 0.42	0.46 - 0.42	0.46 - 0.42	0.46 - 0.42	0.46 - 0.42	0.91 - 0.83	0.91 - 0.83	1.32 - 1.21	1.50 - 1.38	1.50 - 1.38		
Rated current (Heating)	A	0.46 - 0.42	0.46 - 0.42	0.46 - 0.42	0.46 - 0.42	0.46 - 0.42	0.91 - 0.83	0.91 - 0.83	1.32 - 1.21	1.50 - 1.38	1.50 - 1.38		
Sound pressure level	dB(A)	Hi 32 Me 29 Lo 26					Hi 33 Me 29 Lo 25			Hi 38 Me 36 Lo 30		Hi 40 Me 34 Lo 29	
Sound power level	dB(A)	60					64			71		72	
External dimensions (HxLxD)	mm	280 x 750 x 635					280 x 950 x 635		299 x 950 x 635		280 x 1.370 x 740		
Net weight	kg	29					34			54			
Refrigerant circuit/Heat exchanger		Finned and internally grooved pipes											
Refrigerant control		Electronic expansion valve											
Air treatment/fan type & quantity		Centrifugal fan x 2											
Motor	W	100	100	100	100	100	130	130	100 + 130	100 + 200	100 + 200		
Starting method		Direct, in line											
Air flow (standard)	m ³ /h	Hi 600 Me 540 Lo 480					Hi 1140 Me 900 Lo 600			Hi 1680 Me 1500 Lo 1140		Hi 1920 Me 1560 Lo 1200	
Static pressure	Pa	Max 100											
Fresh air inlet		Possible											
Air filter & quantity		Optional											
Shock & vibration absorption		Rubber vibration absorber (for fan motor)											
Thermal & acoustic insulation		Polyurethane foam											
Control devices		Optional Wired control RC-E5; optional RCH-E3; optional RCN-KIT4-E2; optional RC-EX3											
Ambient temperature control		Electronically-controlled thermostat											
Safety devices		Overvoltage protection for the fan motor											
		Anti-frost protection thermostat											
Refrigerant pipings' diameter	mm (in)	Liquid side: Ø6.35 (1/4")					Liquid side Ø9.52 (3/8")			Liquid side Ø9.52 (3/8")		Gas side Ø15.88 (5/8")	
		Gas side: Ø9.52 (3/8")					Gas side: Ø12.7 (1/2")						
Joining method		flare											
Refrigerant		R410A											
Drain pump		Built-in											
Condensate drain		Can be connecte with VP20 or VP25											
Piping insulation		Necessary (on both sides, Liquid & Gas)											
Accessories		UM-FL1EF (Optional)					UM-FL2EF (Optional)			UM-FL3EF (Optional)			

INDOOR UNITS

ALL-OUTSIDE AIR DUCTED



■ **4 capacities**
(9.00~28.00 kW)

- Maximum compactness: only 28 cm (9.00~14.00 kW) and only 37.9 cm (22.40~28.00 kW)
- Max static pressure of fans: 200 Pa
- Automatic function “all-outside air” to save energy when the outdoor temperature drops below the set temperature.
- Can be connected to 8~60HP outdoor units except Micro Compact KXZ (4~6HP) and KXZ Smart

FDU 650~2400 FKXZE1

AIR CONDITIONING AND OUTDOOR AIR INTAKE

The diagram below illustrates the integration of the FDU-F unit inside a KXZ system.

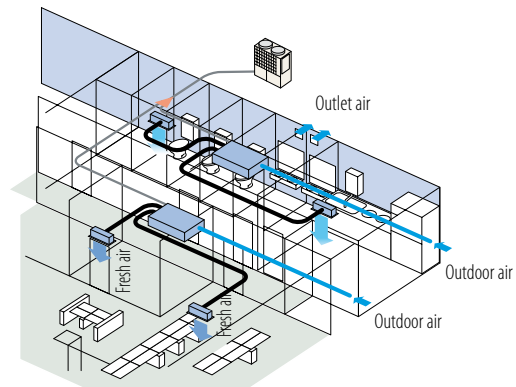
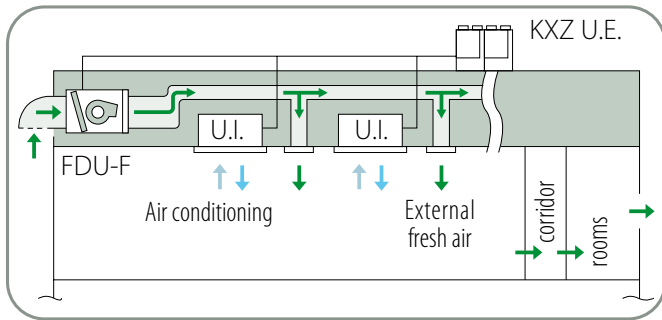

Note: Check the possible connections and limits of use on the technical documentation.

The compact design, the fan static pressure of 200 Pa and the lowest noise level on the market make the unit suitable for installation in environments designed to ensure comfort and relaxation.

Model		FDU 650 FKXZE1	FDU 1100 FKXZE1	FDU 1800 FKXZE1	FDU 2400 FKXZE1
Rated capacity (Cooling)	kW	9.00	14.00	22.40	28.00
Rated capacity (Heating)	kW	6.50	10.50	16.00	21.50
Power supply		220-240V~50Hz			
Power input (Cooling)	kW	0.24 - 0.25	0.35 - 0.36	1.16 - 1.20	1.16 - 1.20
Power input (Heating)	kW	0.24 - 0.25	0.35 - 0.36	1.16 - 1.20	1.16 - 1.20
Rated current (Cooling)	A	1.80 - 1.70	2.30 - 2.20	6.80 - 6.50	6.80 - 6.50
Rated current (Heating)	A	1.80 - 1.70	2.30 - 2.20	6.80 - 6.50	6.80 - 6.50
Sound power level	dB(A)	55	62	68	70
Sound pressure level	dB(A)	Hi 31	Hi 37	Hi 42	Hi 45
External dimensions (HxLxD)	mm	280 x 950 x 635	280 x 1370 x 740	379 x 1600 x 893	379 x 1600 x 893
Net weight	kg	34	54	89	89
Refrigerant circuit/Heat exchanger		Finned and internally grooved pipes			
Refrigerant control		Electronic expansion valve			
Air treatment/fan type & quantity		Centrifugal fan x 2		Centrifugal fan x 3	
Motor	W	130	100 + 200	130 + 350	130 + 350
Starting method		Direct, in line			
Air flow (standard)	m³/h	Hi 660	Hi 1080	Hi 1800	Hi 2400
Static pressure	Pa	Max: 200	Max: 200	Max: 200	Max: 200
Air filter & quantity		To be found locally			
Shock & vibration absorption		Rubber vibration absorber (for fan motor)			
Thermal & acoustic insulation		Polyurethane foam			
Control devices		Wired control: RC-EX3, RC-E5, RCH-E3			
Ambient temperature control		Remote control kit: RCN-KIT4-E2			
Safety devices		Electronic thermostat			
		Thermal protection for the fan motor			
		Anti-frost protection thermostat			
Refrigerant pipings' diameter	mm (inch)	Gas side Ø15.88 (5/8")		Gas side Ø19.05 (3/4")	Gas side Ø22.22 (7/8")
Joining method		flare			to weld
Refrigerant		R410A			
Drain pump		Built-in			
Condensate drain		Can be connected with VP25			
Piping insulation		Necessary (on both sides, Liquid & Gas)			
Accessories included		Condensate drain pipe			

INDOOR UNITS

DUCTED LOW STATIC PRESSURE



7 capacities (1.50~7.10 kW)

- Ideal for applications in hotels, hospitals and small offices
- Optional filter kit: UT-FL1EF (FDUT 15~36); UT-FL2EF (FDUT 45~56); UT-FL3EF (FDUT 71)
- Ducting flange: UT-SAT1EF (FDUT 15~36); UT-SAT2EF (FDUT 45~56); UT-SAT3EF (FDUT 71)
- "Human sensor": LB-KIT2

FDUT 15~71 KXE6F-E

COMPACT SIZE

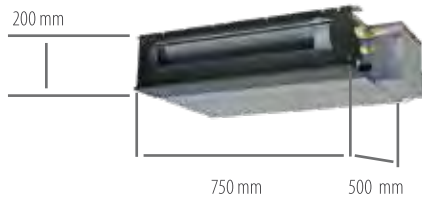

models FDUT 15, 22, 28, 36 KXE6F-E

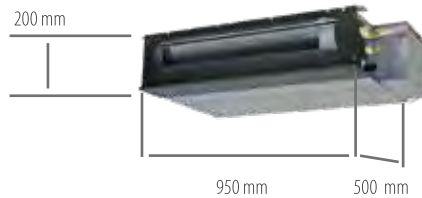

models FDUT 45, 56 KXE6F-E

VERY QUIET OPERATION

Extremely quiet: only 22 dB(A) for models from 1.50~2.80 kW.

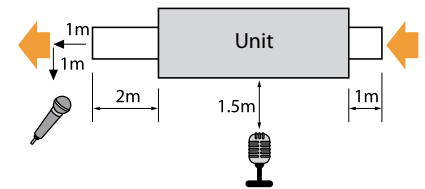

Model		FDUT 15 KXE6F-E	FDUT 22 KXE6F-E	FDUT 28 KXE6F-E	FDUT 36 KXE6F-E	FDUT 45 KXE6F-E	FDUT 56 KXE6F-E	FDUT 71 KXE6F-E
					Rear view			
Rated capacity (Cooling)	kW	1.50	2.20	2.80	3.60	4.50	5.60	7.10
Rated capacity (Heating)	kW	1.70	2.50	3.20	4.00	5.00	6.00	8.00
Power supply		220-240V~50Hz						
Power input (Cooling)	kW	0.06 - 0.06	0.07 - 0.07	0.07 - 0.07	0.07 - 0.07	0.08 - 0.08	0.08 - 0.08	0.08 - 0.08
Power input (Heating)	kW	0.06 - 0.06	0.07 - 0.07	0.07 - 0.07	0.07 - 0.07	0.08 - 0.08	0.08 - 0.08	0.07 - 0.07
Rated current (Cooling)	A	0.27 - 0.27	0.28 - 0.25	0.28 - 0.25	0.32 - 0.29	0.36 - 0.33	0.38 - 0.35	0.42 - 0.42
Rated current (Heating)	A	0.27 - 0.27	0.29 - 0.25	0.29 - 0.25	0.33 - 0.28	0.34 - 0.32	0.35 - 0.33	0.46 - 0.46
Sound pressure level	dB(A)	Hi 28 Me 26 Lo 22			Hi 33 Me 30 Lo 26	Hi 34 Me 32 Lo 28	Hi 35 Me 33 Lo 30	Hi 35 Me 31 Lo 28
Sound power level	dB(A)	52			57	58	59	
External dimensions (HxLxD)	mm	200 x 750 x 500			22	200 x 950 x 500		220 x 1150 x 565
Net weight	kg	21				25	31	
Refrigerant circuit/Heat exchanger		Finned and internally grooved pipes						
Refrigerant control		Electronic expansion valve						
Air treatment/fan type & quantity		Centrifugal fan x 2				Centrifugal fan x 3		Centrifugal fan x 4
Motor	W	14				38		100
Starting method		Direct, in line						
Air flow (standard)	m ³ /h	Hi 360 Me 300 Lo 240	Hi 450 Me 360 Lo 300		Hi 510 Me 420 Lo 330	Hi 690 Me 540 Lo 420	Hi 750 Me 540 Lo 432	Hi 960 Me 780 Lo 570
Static pressure	Pa	St. 10 Max 35				St. 10 Max 50		
Fresh air inlet		Not possible						
Air filter & quantity		UT-FL1EF (Optional)				UT-FL2EF (Optional)		UT-FL3EF (Optional)
Shock & vibration absorption		Rubber vibration absorber (for fan motor)						
Thermal & acoustic insulation		Polyurethane foam						
Control devices		Optional Wired control RC-E5; optional RCH-E3; optional RCN-KIT4-E2; optional RC-EX3						
Ambient temperature control		Electronically-controlled thermostat						
Safety devices		Overvoltage protection for the fan motor; Anti-frost protection thermostat						
Refrigerant pipings' diameter	mm (in)	Gas side ø9.52 (3/8")			Liquid side ø6.35 (1/4")		Gas side ø12.7 (1/2")	
Joining method		flare						
Refrigerant		R410A						
Drain pump		Built-in						
Condensate drain		Can be connected with VP25						
Piping insulation		Necessary (on both sides, Liquid & Gas)						
Accessories		Assembly kit. UT-SAT1EF (Flange)				Assembly kit. UT-SAT2EF (Flange)		Assembly kit. UT-SAT3EF (Flange)

INDOOR UNITS

COMPACT DUCTED



WiFi optional

■ 3 capacities

(2,20~3,60 kW)

- Maximum compactness: only 25.7 cm in height
- Maximum installation flexibility
- Rear air intake from back
- Extremely quiet: only 27 dB(A)
- UH-DU-E condensate drain kit (optional)

FDUH 22~36 KXE6F

THE ELECTRICAL BOX

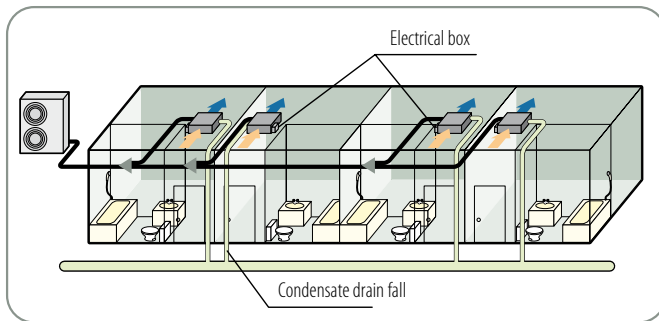

The electrical box and the condensate drain pump can be installed on both sides of the unit, while the incoming air penetrates through the bottom or the back.

The lowest noise impact on the market makes the unit suitable for installation in rooms designed to ensure comfort and relaxation. Compact and lightweight, FDUH is ideal for installation in hotels, hospitals and small offices.

Furthermore, the application of the RCH-E3 remote control (optional) enables the user to take advantage of a simplified device to prepare and make the environment to be air conditions as comfortable as possible.

Model		FDUH 22 KXE6F	FDUH 28 KXE6F	FDUH 36 KXE6F
Rated capacity (Cooling)	kW	2.20	2.80	3.60
Rated capacity (Heating)	kW	2.50	3.20	4.00
Power supply		220-240V~50Hz		
Power input (Cooling)	kW	0.05 - 0.07	0.05 - 0.07	0.05 - 0.07
Power input (Heating)	kW	0.05 - 0.07	0.05 - 0.07	0.05 - 0.07
Rated current (Cooling)	A	0.25 - 0.32	0.25 - 0.32	0.25 - 0.32
Rated current (Heating)	A	0.25 - 0.32	0.25 - 0.32	0.25 - 0.32
Sound pressure level	dB(A)	Hi 33 Me 30 Lo 27		
Sound power level	dB(A)	60		
External dimensions (HxLxD)	mm	Unit 257 x 570 x 530		
Net weight	kg	22		
Refrigerant circuit/Heat exchanger		Finned and internally grooved pipes		
Refrigerant control		Electronic expansion valve		
Air treatment/fan type & quantity		Centrifugal fan x 1		
Motor	W	30		
Starting method		Direct, in line		
Air flow (standard)	m ³ /h	Hi 420 Me 390 Lo 360		
Static pressure	Pa	30		
Fresh air inlet		Not possible		
Air filter & quantity		Optional		
Shock & vibration absorption		Rubber vibration absorber (for fan motor)		
Thermal & acoustic insulation		Polyurethane foam		
Control devices		Optional Wired control RC-E5; optional RCH-E3; optional RCN-KIT4-E2; optional RC-EX3		
Ambient temperature control		Electronically-controlled thermostat		
Safety devices		Overvoltage protection for the fan motor		
		Anti-frost protection thermostat		
Refrigerant pipings' diameter	mm (in)	Liquid side Ø6.35 (1/4")		Gas side: Ø12.7 (1/2")
Joining method		Gas side Ø9.52 (3/8")		
Refrigerant		flare		
Condensate drain		R410A		
Piping insulation		Can be connected with VP20		
Accessories		Necessary (on both sides, Liquid & Gas)		
		UH-FL1E (Filter); UH-DU-E (Condensate drain pump)		

INDOOR UNITS

WALL



FDK 15-56 KXZE1



FDK 71-90 KXZE1



WiFi
optional

■ 8 capacities

- (1.50-9.00 kW)
- Simple, modern design for seamless integration into any environment (1.50- 5.60 kW)
- Maximum compactness: only 23 cm deep (1.50-5.60 kW)
- Simplified maintenance and cleaning thanks to the easily removable front panel
- "Human sensor": LB-KIT2

Model		FDK 15 KXZE1	FDK 22 KXZE1	FDK 28 KXZE1	FDK 36 KXZE1	FDK 45 KXZE1	FDK 56 KXZE1	FDK 71 KXZE1	FDK 90 KXZE1	
Rated capacity (Cooling)	kW	1.50	2.20	2.80	3.60	4.50	5.60	7.10	9.00	
Rated capacity (Heating)	kW	1.70	2.50	3.20	4.00	5.00	6.30	8.00	10.00	
Power supply		220-240V~ 50Hz								
Power input (Cooling)	kW	0.02	0.02	0.02	0.03	0.03	0.03	0.04	0.05	
Power input (Heating)	kW	0.02	0.02	0.02	0.03	0.03	0.03	0.04	0.05	
Rated current (Cooling)	A	0.18 - 0.16	0.18 - 0.16	0.18 - 0.16	0.27 - 0.25	0.27 - 0.25	0.27 - 0.25	0.34 - 0.31	0.42 - 0.39	
Rated current (Heating)	A	0.18 - 0.16	0.18 - 0.16	0.18 - 0.16	0.27 - 0.25	0.27 - 0.25	0.27 - 0.25	0.34 - 0.31	0.42 - 0.39	
Sound pressure level (Cooling)	dB(A)	PHi 38 Hi 34 Me 31 Lo 28			PHi 40 Hi 38 Me 33 Lo 28		PHi 43 Hi 41 Me 36 Lo 33		PHi 42 Hi 40 Me 37 Lo 35	
Sound pressure level (Heating)		PHi 38 Hi 34 Me 31 Lo 28			PHi 40 Hi 38 Me 33 Lo 28		PHi 43 Hi 41 Me 36 Lo 33		PHi 42 Hi 40 Me 37 Lo 35	
Sound power level (Cooling)	dB(A)	54			55		58		59	
Sound power level (Heating)		54			55		58		59	
External dimensions (HxLxD)	mm	290x870x230						339x1197x262		
External appearance		Snow white								
Munsell color		(8.0Y9.3/0.1) similar								
Net weight	kg	11.5	11		12	11.5		17		
Refrigerant circuit/Heat exchanger		Finned and internally grooved pipes								
Refrigerant control		Electronic expansion valve								
Air treatment/fan type & quantity		Tangential x1								
Motor	W	42						56		
Starting method		Direct, in line								
Air flow (Cooling)	m³/h	PHi 342 Hi 300 Me 270 Lo 216			PHi 510 Hi 480 Me 360 Lo 300		PHi 660 Hi 600 Me 480 Lo 420		PHi 720 Hi 660 Me 540 Lo 480	
Air flow (Heating)		PHi 342 Hi 300 Me 270 Lo 216			PHi 510 Hi 480 Me 360 Lo 300		PHi 660 Hi 600 Me 480 Lo 420		PHi 720 Hi 660 Me 540 Lo 480	
Static pressure	Pa	0								
Fresh air inlet		Not available								
Air filter & quantity		Propylene mesh filter x 2 (washable)								
Shock & vibration absorption		Rubber vibration absorber (for fan motor)								
Thermal & acoustic insulation		Polyurethane foam								
Control devices		Wired control: RC-EX3, RC-ES, RCH-E3								
Ambient temperature control		Remote control kit: RCN-K-E2								
Safety devices		Electronically-controlled thermostat								
		Thermal protection for the fan motor								
		Anti-frost protection thermostat								
Refrigerant pipings' diameter	mm (inch)	Liquid side: Ø6.35 (1/4")				Gas side: Ø12.7 (1/2")		Liquid side: Ø9.52 (3/8")		
Joining method		Gas side: Ø9.52 (3/8")				Gas side: Ø12.7 (1/2")		Gas side: Ø15.88 (5/8")		
Refrigerant		flare R410A								
Condensate drain		Can be connected with VP16								
Piping insulation		Necessary (on both sides: Liquid & Gas)								
Accessories included		Assembly kit								

INDOOR UNITS

CEILING



■ 6 capacities

- (3.60~14.0 kW)
- Ideal for very large environments, thanks to the particularly wide air flow
- Maximum compactness: only 21 cm high (3.60 to 7.10 kW models)
- Quick and easy installation, thanks to a net weight of only 28 kg (3.60 to 5.60 kW models)
- Reception kit for RCN-E-E2 infrared remote control (optional)
- "Human sensor": LB-E

FDE 36-140 KXZE1

FLEXIBLE PIPE ORIENTATION

Maximum flexibility: the refrigerant piping can be attached in 3 different positions (rear, top, right), as can that of the condensate drain (left, right).

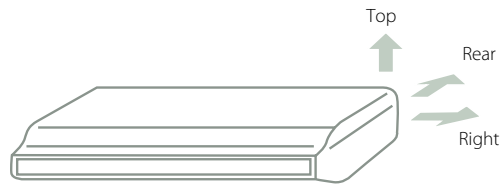

Model		FDE 36 KXZE1	FDE 45 KXZE1	FDE 56 KXZE1	FDE 71 KXZE1	FDE 112 KXZE1	FDE 140 KXZE1		
Rated capacity (Cooling)	kW	3.60	4.50	5.60	7.00	11.20	14.00		
Rated capacity (Heating)	kW	4.00	5.00	6.30	8.00	12.50	16.00		
Power supply		220-240V ~ 50Hz							
Power input (Cooling)	kW	0.05 - 0.06	0.05 - 0.06	0.05 - 0.06	0.10 - 0.11	0.14 - 0.16	0.16 - 0.18		
Power input (Heating)	kW	0.05 - 0.06	0.05 - 0.06	0.05 - 0.06	0.09 - 0.10	0.13 - 0.15	0.15 - 0.17		
Rated current (Cooling)	A	0.25 - 0.26	0.25 - 0.26	0.25 - 0.26	0.46 - 0.48	0.65 - 0.67	0.77 - 0.78		
Rated current (Heating)	A	0.23 - 0.25	0.23 - 0.25	0.23 - 0.25	0.42 - 0.44	0.59 - 0.63	0.70 - 0.72		
Sound pressure level	dB(A)	Hi 39 Me 38 Lo 36			Hi 41 Me 39 Lo 37		Hi 44 Me 41 Lo 39	Hi 46 Me 44 Lo 43	
Sound power level	dB(A)	60			62		61	64	
External dimensions (HxLxD)	mm	210 x 1.070 x 690			210 x 1.320 x 690		250 x 1.620 x 690		
External appearance		Chalk white							
Munsell color		(6.8Y8.9 / 0.2) similar							
Net weight	kg	28			37		49		
Refrigerant circuit/Heat exchanger		Finned and internally grooved pipes							
Refrigerant control		Electronic expansion valve							
Air treatment/fan type & quantity		Centrifugal fan x 2			Centrifugal fan x 4				
Motor	W	25			20 x 2		30 x 2		40 x 2
Starting method		Direct, in line							
Air flow (standard)	m ³ /h	Hi 600 Me 540 Lo 420			Hi 960 Me 840 Lo 720		Hi 1560 Me 1380 Lo 1260		Hi 1740 Me 1560 Lo 1380
Static pressure	Pa	0							
Fresh air inlet		Not possible							
Air filter & quantity		Plastic mesh filter x 2 (washable)							
Shock & vibration absorption		Rubber vibration absorber (for fan motor)							
Thermal & acoustic insulation		Polyurethane foam							
Control devices		Optional Wired control RC-E5; optional RCH-E3; optional RCN-E-E2; optional RC-EX3							
Ambient temperature control		Electronically-controlled thermostat							
Safety devices		Overvoltage protection for the fan motor							
		Anti-frost protection thermostat							
Refrigerant pipings' diameter	mm (in)	Liquid side Ø6.35 (1/4") Gas side Ø12.7 (1/2")			Liquid side Ø9.52 (3/8") Gas side Ø15.88 (5/8")				
Joining method		flare							
Refrigerant		R410A							
Condensate drain		Can be connected with VP20							
Piping insulation		Necessary (on both sides, Liquid & Gas)							
Accessories		Assembly kit							

INDOOR UNITS

CONSOLE



■ 3 capacities

- (2.80~5.60 kW)
- Particularly wide, uniform air flow
- Maximum compactness: only 23.8 cm deep
- Quick and easy installation, thanks to a net weight of only 19 kg (2.80 kW models)
- Reception kit for RCN-FW-E2 infrared remote control (optional)

FDFW 28-56 KXE6F

UNIFORM AIR DISTRIBUTION

Simultaneous louvre selection - top and bottom - can be selected at the same time using the special button. Control all other functions on the unit with the special remote control.

With infrared remote control use

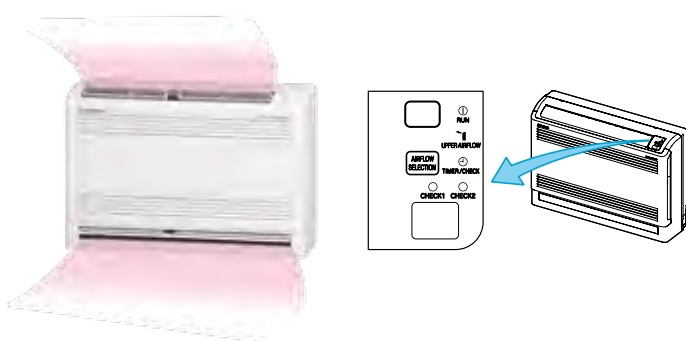

Model		FDFW 28 KXE6F	FDFW 45 KXE6F	FDFW 56 KXE6F
Rated capacity (Cooling)	kW	2.80	4.50	5.60
Rated capacity (Heating)	kW	3.20	5.00	6.30
Power supply		220-240V~50Hz		
Power input (Cooling)	kW	0.02 - 0.02	0.02 - 0.02	0.03 - 0.03
Power input (Heating)	kW	0.02 - 0.02	0.02 - 0.02	0.03 - 0.03
Rated current (Cooling)	A	0.10 - 0.09	0.10 - 0.09	0.15 - 0.14
Rated current (Heating)	A	0.10 - 0.09	0.10 - 0.09	0.15 - 0.14
Sound pressure level	dB(A)	Hi 36 Me 34 Lo 30	Hi 38 Me 36 Lo 33	Hi 44 Me 37 Lo 33
Sound power level	dB(A)	55	57	60
External dimensions (HxLxD)	mm	600 x 860 x 238		
External appearance		Fine snow		
Munsell color		(8.0Y9.3 / 0.1) similar		
Net weight	kg	19	20	
Refrigerant circuit/Heat exchanger		Finned and internally grooved pipes		
Refrigerant control		Electronic expansion valve		
Air treatment/fan type & quantity		Turbo fan x 1		
Motor	W	40		
Starting method		Direct, in line		
Air flow (standard)	m³/h	Hi 540 Me 480 Lo 420	Hi 660 Me 540 Lo 480	
Static pressure	Pa	0		
Fresh air inlet		Not possible		
Air filter & quantity		Propylene mesh filter x 1 (washable)		
Shock & vibration absorption		Rubber vibration absorber (for fan motor)		
Thermal & acoustic insulation		Polyurethane foam		
Control devices		Optional Wired control RC-E5; optional RCH-E3; optional RCN-FW-E2; optional RC-EX3		
Ambient temperature control		Electronically-controlled thermostat		
Safety devices		Overvoltage protection for the fan motor Anti-frost protection thermostat		
Refrigerant pipings' diameter	mm (in)	Gas side Ø9.52 (3/8")	Gas side Ø12.7 (1/2")	
Joining method		flare		
Refrigerant		R410A		
Condensate drain		Can be connected with VP16 (I.D. 16.0)		
Piping insulation		Necessary (on both sides, Liquid & Gas)		
Accessories		Assembly kit		

INDOOR UNITS

FLOOR RECESSED



FDFU 28-71 KXE6F

■ 4 capacities

[2.80-7.10 kW]

- Maximum compactness: only 63 cm high and 22.5 cm deep

Model		FDFU 28 KXE6F	FDFU 45 KXE6F	FDFU 56 KXE6F	FDFU 71 KXE6F
Rated capacity (Cooling)	kW	2.80	4.50	5.60	7.10
Rated capacity (Heating)	kW	3.20	5.00	6.30	8.00
Power supply		220-240V~ 50Hz			
Power input (Cooling)	kW	0.09 - 0.10	0.09 - 0.10	0.09 - 0.10	0.09 - 0.10
Power input (Heating)	kW	0.09 - 0.10	0.09 - 0.10	0.09 - 0.10	0.09 - 0.10
Rated current (Cooling)	A	0.41 - 0.42	0.41 - 0.42	0.41 - 0.42	0.41 - 0.42
Rated current (Heating)	A	0.41 - 0.42	0.41 - 0.42	0.41 - 0.42	0.41 - 0.42
Sound pressure level	dB(A)	Hi 41 Me 38 Lo 36		Hi 43 Me 41 Lo 40	
Sound power level	dB(A)	58		60	
External dimensions (HxLxD)	mm	630 x 1.077 x 225			630 x 1.362 x 225
Net weight	kg	25			32
Refrigerant circuit/Heat exchanger		Finned and internally grooved pipes			
Refrigerant control		Electronic expansion valve			
Air treatment/fan type & quantity		Centrifugal fan x 2			
Motor	W	30		40	
Starting method		Direct, in line			
Air flow (standard)	m ³ /h	Hi 720 Me 660 Lo 600	Hi 840 Me 720 Lo 600		Hi 1080 Me 900 Lo 720
Static pressure	Pa	0			
Fresh air inlet		Not possible			
Air filter & quantity		Propylene mesh filter x 1 (washable)			
Shock & vibration absorption		Rubber vibration absorber (for fan motor)			
Thermal & acoustic insulation		Polyurethane foam			
Control devices		Optional Wired control RC-E5; optional RCH-E3; optional RCN-KIT4-E2; optional RC-EX3			
Ambient temperature control		Electronically-controlled thermostat			
Safety devices		Overvoltage protection for the fan motor			
		Anti-frost protection thermostat			
Refrigerant pipings' diameter	mm (in)	Gas side Ø9.52 (3/8")	Liquid side Ø6.35 (1/4")		Liquid side Ø9.52 (3/8") Gas side Ø15.88 (5/8")
Joining method		flare			
Refrigerant		R410A			
Condensate drain		Can be connected with VP20			
Piping insulation		Necessary (on both sides, Liquid & Gas)			
Accessories		Assembly kit			



ENTHALPY HEAT RECOVERY UNIT

- SAF 150E7
- SAF 250E7
- SAF 350E7
- SAF 500E7
- SAF 800E7
- SAF 1000E7



During winter, these units recover some of the energy contained in the renewal air expelled from the rooms that would otherwise be dispersed into the atmosphere, using it to preheat the air coming in from outside.

During summer, the exchange is more effective in warmer climates, where the cool air expelled is used to pre-cool the air coming in from outside.

The recovery of dispersed energy reduces the heating requirements of the spaces in a building, ensuring lower emissions and considerable long-term savings on energy consumption and system maintenance. Wired control included.

Structure (SAF 800E7)

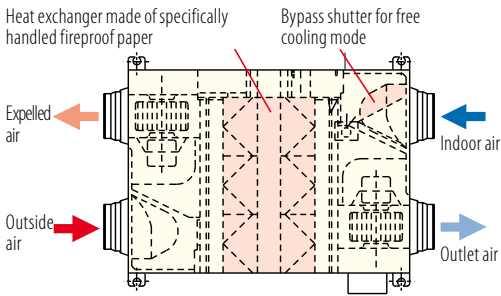

Operating principle in free cooling mode

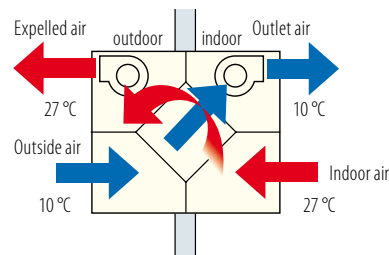

Operating principle in heat recovery mode

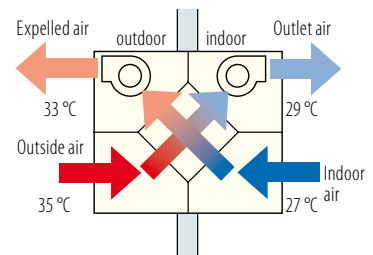

Warning: the drawings above represent only the operation principles; they do not represent the real position of the air inlets. For the correct position, refer to the drawing on the left.

Model	SAF 150E7		SAF 250E7		SAF 350E7		SAF 500E7		SAF 800E7		SAF 1000E7	
Type	Enthalpy heat recovery unit											
Control (included)	Wired control											
Enthalpy exchange efficiency ¹	Cooling	%	63	63	66	62	65	65				
	Heating	%	70	70	69	67	71	71				
Heat exchange efficiency	%	75	75	75	75	75	75					
Electrical data		Ph-V-Hz	1-220~240-50									
Rated power	W	92~107	108~123	178~185	204~225	360~378	416~432					
Rated absorbed current	A	0.42~0.45	0.49~0.51	0.77~0.81	0.93~0.94	1.58~1.64	1.80~1.89					
Product specifications												
External dimensions	LxDxH	mm	970x467x270	882x599x270	1050x804x317	1090x904x317	1322x884x388	1322x1134x388				
Net weight		Kg	25	29	49	57	71	83				
Sound pressure level	Max	dB(A)	29	31.5	33	37.5	37.5	38.5				
Volume of air treated		m ³ /h	150	250	350	500	800	1000				
Fan static pressure	Max	Pa	80	105	140	120	140	105				
Ducting flange		mm	ø98	ø144	ø144	ø194	ø242	ø242				
Operating range	Max UR 85%	°C	-10~40									
Specific energy consumption ²	SEC	kWh/m ² y	-28.6	-	-	-	-	-				
SEC class ²			B	-	-	-	-	-				

1 Values related to the maximum speed of the 3 levels settable by wired remote control. 2 Mandatory data for residential ventilation units (RVU) only. Reference standards: EU Ecodesign Directive 1253/2014 for non-residential ventilation units (NRVU) and residential ventilation (RVU). EU Energy Labelling 1254/2014 Residential Ventilation Unit (RVU).

POST-TREATMENT MODULAR UNIT

- SAF DX250E6
- SAF DX350E6
- SAF DX500E6
- SAF DX800E6
- SAF DX1000E6

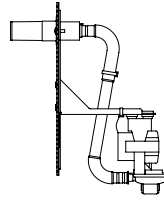

DXA-DU-E: condensate drain kit up to 60 cm (optional)

The simple and flexible solution for increasing comfort in buildings, with high energy performance

The SAF DX units, available in 5 power ratings, is a device designed to increase the comfort capacity of KXZ systems located in buildings, with their high quality profile in terms of energy.

Extremely flexible in that it operates independently from the regenerator, it is able to optimise temperature of the primary air taken in by the SAF regenerators or by similar systems installed in the building. Its compact size and installation separate from the fan unit, solve numerous installation problems; the lack of moving parts makes it possible to install the unit in a wider range of locations and reduces noise to a minimum.

The SAF DX post-treatment is not intended to replace an indoor unit.

- Can be combined with all indoor and outdoor units in the KXZ range*.
- Can be connected to the Superlink network and all the available centralised controls.
- It is possible to use all the KXZ series local controls (to integrate into the system seamlessly and easily).
- The condensate drain pump is available as an optional.
- It allows you to control the inlet temperature or outlet temperature alternatively**.

Note

If using the SAF DX, the load index available for the outdoor unit is reduced to 100% of the rated capacity.

The available options vary depending on configurations.

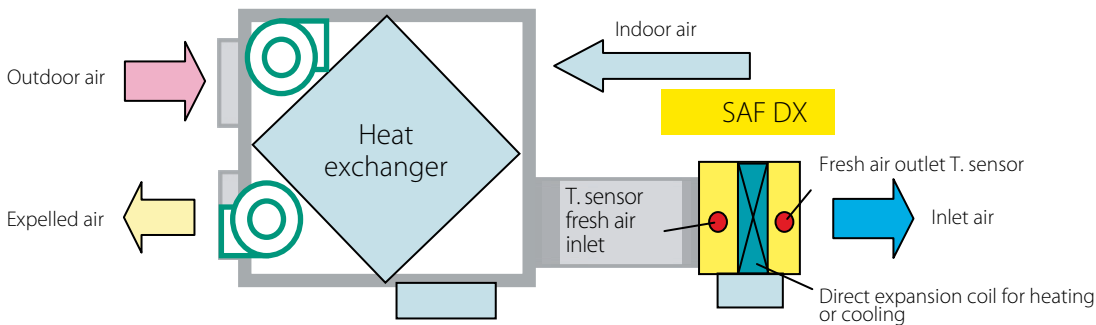

Unit model		SAF DX250E6	SAF DX350E6	SAF DX500E6	SAF DX800E6	SAF DX1000E6
Rated capacity (Cooling)*	kW	2.00	2.80	3.60	5.60	6.30
Rated capacity (Heating)**	kW	1.80	2.20	2.80	4.50	5.60
Power supply		220-240V ~ 50Hz				
Power input (Cooling)	W	7.20				
Power input (Heating)	W	7.20				
Rated current (Cooling)	A	0.05				
Rated current (Heating)	A	0.05				
External dimensions (H x L x D)	mm	315 x 452 x 422		315 x 537 x 422	315 x 682 x 422	315 x 822 x 422
Net weight	kg	12.3		13.6	16.1	18.4
Air flow (standard)	m ³ /h	250	350	500	800	1000
Static pressure	Pa	38		66		
Control devices		Optional Wired control RC-E5; optional RCH-E3; optional RCN-KIT4-E2				
Refrigerant pipings' diameter	mm (in)	Liquid side: ø 6.35 (1/4") Gas side: ø 9.52 (3/8")		Liquid side: ø 6.35 (1/4") Gas side: ø 12.7 (1/2")		Liquid side: ø 9.52 (3/8") Gas side: ø 15.88 (5/8")

Mode	Inlet air temperature/ventilation		Outdoor temperature		Standard
	DB	WB	DB	WB	
Cooling*	27° C	19° C	35° C	24° C	ISO- T1
Heating**	20° C		7° C	6° C	

* Measured under the conditions specified in the table.

** ISO-T1-compliant test.

CONTROL SYSTEM FOR AHU EEV-KIT

EEV-KIT is a control kit for any type of AHU and/or fan coil with direct expansion coil that can be found on the market, which permits connection with KXZ O.U.

EEV-KIT consists of an electronic control system and an electronic expansion valve for refrigerant flow control.

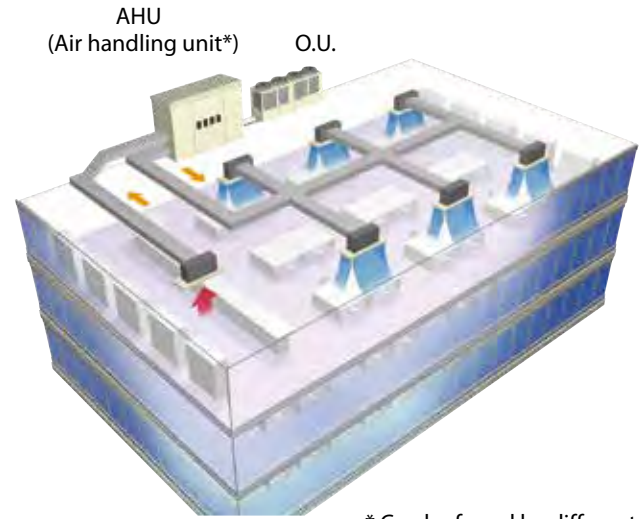

* Can be found by different manufacturers on the market

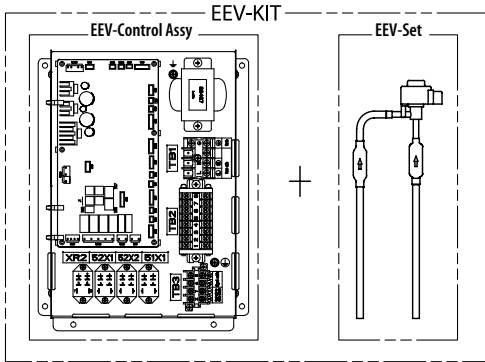

APPLICATIONS

Type of system	EEV-KIT		
	EEVKIT6-E-M	EEV6-160-E	EEVKIT6-E-C
Single	-	-	1 or more boxes in parallel*
Multiple	1 box (Master)	-	Multiple boxes (Slave)
Model	EEV6-71-E	EEV6-160-E	EEV6-280-E
Capacity (kW)	2.20~7.10	9.00~16.00	22.40~28.00

* Can connect to a single cooling system. In the case of more than one cooling system, make sure to use EEV-KIT control ASSY for multiple systems.

SYSTEM CONFIGURATION

- In the case of a single cooling system, you must use one EEVKIT6-E-C control for each expansion valve up to a maximum of 32.
- In the case of a multiple cooling system, you must use one EEVKIT6-E-M 1 master control + no. EEVKIT6-E-C controls, up to a maximum of 32.
- EEVKIT6-E-C control is common use for single and multiple systems.

SINGLE COOLING SYSTEM

A system composed of several outdoor units with a single cooling circuit (see the two examples below). In the figure to the left, system A uses one single EEV-KIT. In the figure to the right, system B uses more than one EEV-KIT.

SYSTEM A

This system only has an EEV-KIT installed on an internal coil consisting of a single exchanger. This type of system can be applied to internal coils with maximum power 10HP (28 kW).

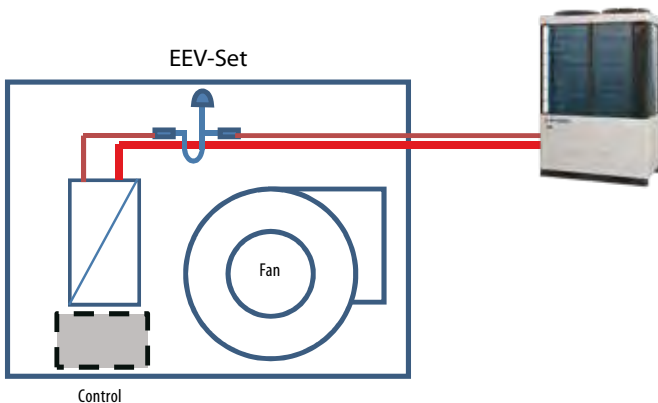

SYSTEM B

It is a system that has more than one EEV-KIT installed in an internal coil consisting of multiple exchangers in a single cooling circuit. This system can reach a maximum power of 60HP (KXZ).

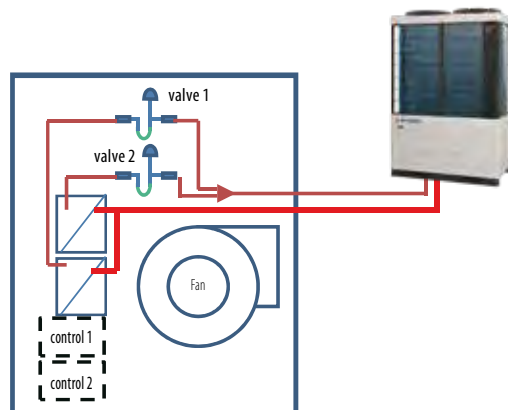

MULTIPLE COOLING SYSTEM

CONTROL SYSTEM FOR AHU EEV-KIT

This system is composed of an air handling unit with the following characteristics:

1. Multiple cooling circuits;
2. Presence of a Master control system that controls the whole system.

ADVANTAGES

- Possibility of extending the system, compared to the single system, up to a power of 896 kW (indoor unit: composed of 32 circuits for 28 kW).
- Possibility of remote control through a special connector.
- Possibility of controlling steps.

PARTS TO BE ADDED TO THE SINGLE COOLING SYSTEM

- A Master control system.
- Slave control system and the expansion valve are the same that are used.

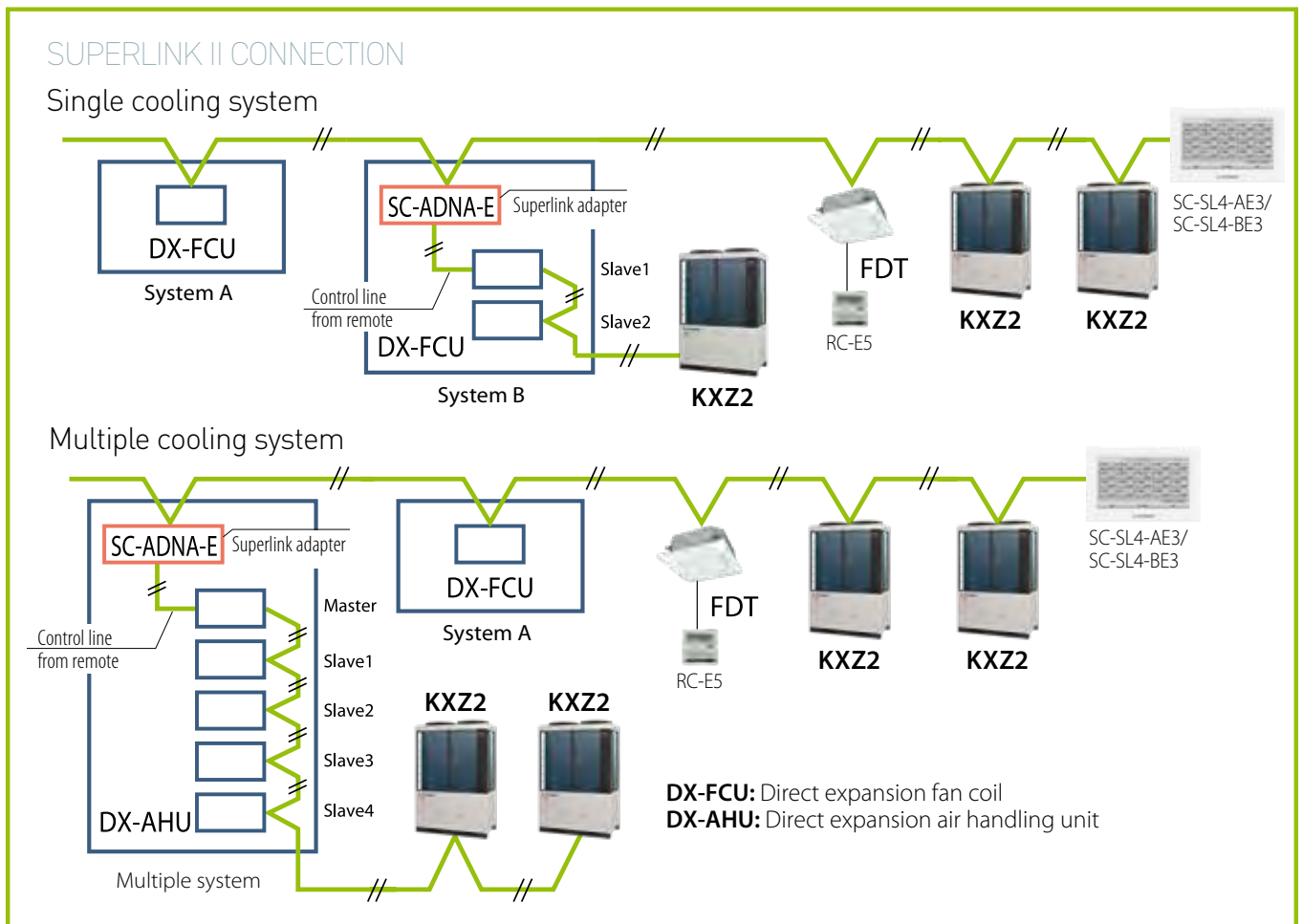
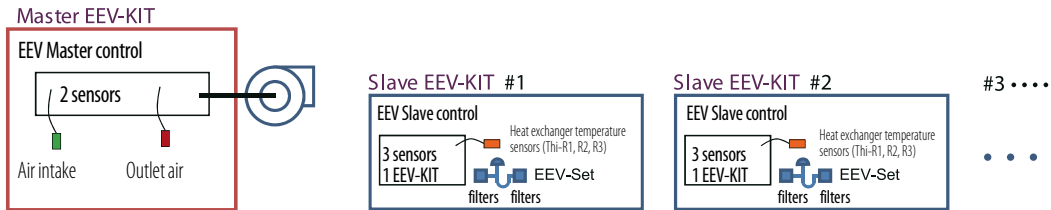
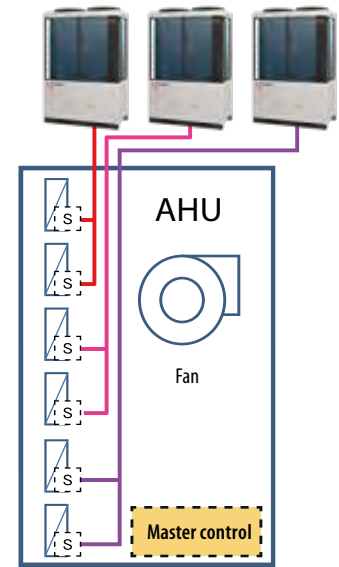

CONTROLS

CONTROLS



172	STANDARD REMOTE CONTROLS
173	OPTIONAL INDIVIDUAL CONTROLS
176	OPTIONAL KIT FOR REMOTE CONTROL
178	WI-FI
180	CENTRALIZED CONTROLS
181	CONTROL DEVICES
182	SUPERLINK II
184	M-ACCESS
186	INTESIS - BMS INTERFACES

REMOTE CONTROLS

SRK ZTX/ZSX/ZS/ZR
SRF ZS/ZSX
SRR ZS

FUNCTIONS

- ON/OFF.
- Operating modes: auto, cooling, heating, dehumidifying and ventilation.
- Fan speed.
- HIGH POWER function.
- ECO function.
- SILENT function (not available on SRR models).
- Air distribution with vertical swinging of air outlet flaps (not available on SRR models).
- Air distribution with horizontal swinging of air outlet flaps (not available on SRR and SRF models).
- 3D AUTO function (not available on SRR and SRF models).
- NIGHT SETBACK function.
- Daily ON/OFF timer.
- Weekly Timer.
- SLEEP.
- ALLERGEN CLEAR function (not available on SRR models).
- Key lock.
- Settings' reset (ACL).
- Clock setting (TIME SETUP).
- MENU button (available only on models ZSX and ZS series).

SRK ZTL

FUNCTIONS

- ON/OFF.
- Operating modes: auto, cooling, heating, dehumidifying and ventilation.
- Fan speed.
- Air distribution with vertical swinging of air outlet flaps.
- Air distribution with horizontal swinging of air outlet flaps.
- 3D AUTO function.
- HIGH POWER function.
- ECO function.
- SILENT function.
- FUZZY AUTO function.
- ALLERGEN CLEAR function.
- Self Clean operation.
- NIGHT SETBACK function.
- Daily ON/OFF timer.
- Child Lock.
- LED brightness adjustment.

DETAIL OF THE CONTROL FUNCTIONS

- **HIGH POWER:** the unit runs at very high speed to quickly reach the temperature in the set cooling or heating mode.
- **ECO:** the set temperature will be automatically adjusted to avoid excessive cooling or heating.
- **SILENT:** reduction in the speed of the external fan and compressor.
- **3D AUTO:** automatic swinging of air outlet flaps (vertical and/or horizontal) according to the room temperature and to the set temperature.
- **NIGHT SETBACK:** prevents the room temperature from falling below 10° C.
- **SLEEP:** night-time dampening function.
- **ALLERGEN CLEAR:** activation of anti-allergenic filter.
- **MENU:** button to adjust the brightness of the indicators on the indoor unit, to select the AUTO OFF function, the CLEAN function and the PRESET function.
- **AUTO OFF:** if after 1 hour (settable from 1 to 2 hours by remote control) the environment continues to be free of people, the air conditioner stops operation and switches to "stand-by" mode.
- **CLEAN:** this function identifies the automatic mold sanitization program and can be performed at the end of the machine's operating cycle.
- **PRESET:** activation of the pre-set heating or cooling operating mode.

STANDARD CONTROLS

REMOTE CONTROLS

SRK/ SKM ZSP



FUNCTIONS

- ON/OFF.
- Operating modes: auto, cooling, heating, dehumidifying and ventilation.
- Fan speed.
- HIGH POWER function.
- ECO function.
- Air distribution with vertical swinging of air outlet flaps.
- Daily ON/OFF timer.
- SLEEP.
- CLEAN function.
- Settings' reset (ACL).
- Clock setting.

OPTIONAL CONTROLS

INDIVIDUAL CONTROLS

WIRED CONTROL WITH LCD DISPLAY RC-E5

Wired remote control with LCD display: this display is large and high-contrast for excellent display of information. The wired remote control is capable of controlling up to 16 indoor units.

Main functions:

- Standard weekly timer.
- Built-in temperature sensor.
- Settable temperature ranges.
- Data saving function.
- 4 fan speeds.
- Control for adjusting the static pressure (for FDU and FDUM models).



SIMPLIFIED WIRED CONTROL RCH-E3

Particularly suitable for use in hotels and small offices, it enables the selection of 3 different ventilation modes.

The simplified wired remote control is capable of controlling up to 16 indoor units.

Simple to use, it has the following essential buttons:

- On/Off.
- Mode.
- Temp. setting.
- Fan speed.
- Built-in temperature sensor.



INDIVIDUAL CONTROLS

MULTILINGUAGE DESIGN CONTROL
RC-ES1

Design wired control with color LCD display and touch buttons: compact and without frames, this control is particularly suitable for integrating into environments such as hotel rooms.

Through a dedicated smartphone app, through which it is possible to connect up to 5 devices to the control at the same time, it is possible to have complete access to all the functions of the control and also makes configuring the units extremely simple.

Finally, the use of this app allows you to obtain data regarding the operation of the machine (electricity consumption based on the operating mode, error reporting, etc.).

The wired controller can control up to 16 indoor units.

Simple to use, the command has the following main functions:

- On/off.
- Operating modes: heating, cooling, ventilation, dehumidification and automatic.
- Fan speed.
- High power function.
- Timer.
- Airflow orientation.
- Built-in temperature sensor.



OPTIONAL CONTROLS

INDIVIDUAL CONTROLS

MULTILINGUAL TOUCH SCREEN CONTROL RC-EX3A

- Touch screen wired remote control with LCD display.
- Large size: 3.8" with backlighting.
Simple 3-button interface.
All settings can be made via the touch screen panel.
- Possibility of selecting up to 9 languages.



ENERGY SAVING FUNCTIONS

- Off timer.
- Peak-cut timer.
- Automatic temp setback.
- Weekly timer.
- Set On/Off timer by hour.
- Set On/Off timer by clock.

FUNCTIONS THAT GUARANTEE COMFORT

- Individual control of air outlet flaps.
- Silent mode.
- Temperature maintenance function.
- Restoring the last set temperature.
- 0.5° C temperature increase setting.

SERVICES

- Error code display.
- Filter cleaning signal.
- Next display data.
- Contact company display.
- USB connection (mini-B).

ADVANTAGES

- LCD display contrast setting.
- Backlighting.
- Filter icon.
- Sound control.
- Outdoor unit silent mode.
- Summer time setting.
- "Home leave" mode.
- Indoor and outdoor temperature display.
- Heating stand-by display.
- Defrost operation display.
- Modes: auto, cooling, heating.
- Display °C / °F.
- Administrator settings.
- Room name setting.
- Anti-draft panel control (for FDT and FDTC models only).

RC-EX3A control via software

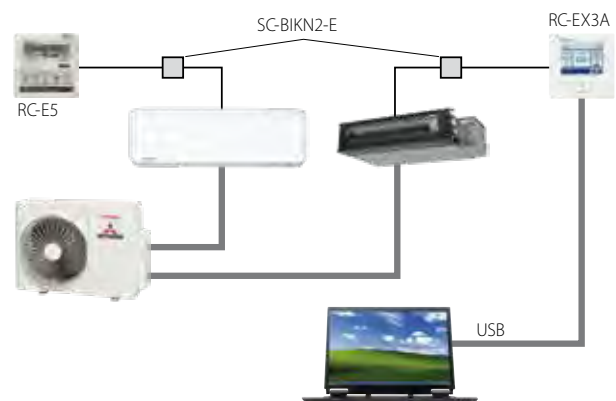

RC-EX 3A control can be controlled via computer by using a special software.

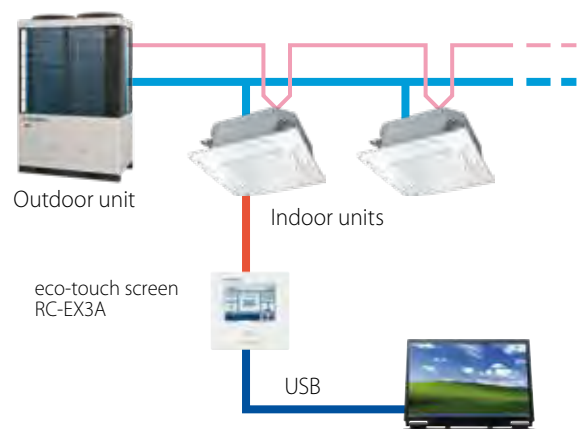

RC-EX 3A control can be controlled via computer by using a special software.

OPTIONAL CONTROLS

REMOTE CONTROL KIT

RCN-KIT4-E2

FDUM, FDU, FDTQ,
FDQS, FDUT, FDUH,
FDFL, FDFU, FDF,
FDU-F, SAF-DX



RCN-TW-E2

FDTW



RCN-T-5BW-E2 RCN-TC-5AW-E3

FDT, FDTC



RCN-T-5BB-E2

FDT



RCN-TS-E2

FDTs



RCN-K-E2

FDK



RCN-K71-E2

FDK71KXZE1



RCN-E-E3

FDE



RCN-FW-E2

FDFW

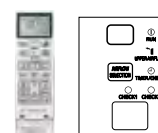

CONTROL DEVICES WITH SUPERLINK II

	Type	Model	nb. of connectable I.U.	
Individual controls	Wired control	RC-EX3A; RC-EXZ3A; RC-E5; RCH-E3	16	
	IR remote control	RCN-KIT4-E2; RCN-T-5BB-E2; RCN-T-5BW-E2; RCN-TC-5AW-E3; RCN-TW-E2; RCN-TS-E2; RCN-K-E2; RCN-K71-E2; RCN-E-E3; RCN-FW-E2	16	
Centralized control panel	Keyboard	SC-SL1N-E	16	
		SC-SL2NA-E	64	
	PC Windows interface	Touch screen	SC-SL4-AE3	128
			SC-SL4-BE3	128
	PC Windows interface BMS interface	WEBnet BACnet	SC-WBGW256	256 (128x2)
BMS interface	Lonworks	SC-LGWNB	96 (48x2)	

OPTIONAL CONTROLS

REMOTE CONTROL KIT

SC-ADNA-E INTERFACE BOARD

This interface board makes it possible to connect the indoor units to the Superlink II network, thus ensuring they can be managed using the SC-SL2N-E device and other central controllers.

Functions:

- transmission of Superlink II data bus information directed towards the indoor units connected;
- ability to block the settings of the single indoor units from a centraliser (remote);
- transmission of the signal showing any faults with the indoor units connected to the Superlink II device, displaying an error code.



SUPERLINK II CONNECTION

Model	Interface	Controls
SRK ZSX SRK ZS SRK ZTL SRK ZR SRF ZS, ZSX, ZMX SRR ZS, ZM	SC-BIKN2-E SC-ADNA-E	RC-E5 RC-EX3A
FDTC VH1, VH, VF FDT VH FDUM VH FDU VH FDE VH FDF VH	SC-ADNA-E	

SC-BIKN2-E OPTIONAL KIT

This interface board makes it possible to create a 2-wire X, Y network on the SRK units, enabling management using the RC-E5 wired remote control. Furthermore, using the SC-ADNA-E card connected directly to the SC-BIKN2-E card, it is possible to connect the unit to the Superlink II network and centralise management of SRK units using remote controls for all functions. The interface card is contained in a box fastened to the wall measuring 120x135x29 mm. The card is also equipped with a CnT connector, which enables the SRK units to exchange the digital inputs/outputs with an external control.

WIRED CONTROL CONNECTION

Model	Interface	Controls
SRK ZSX SRK ZS SRK ZTL SRK ZR SRF ZS, ZSX, ZMX SRR ZS, ZM	SC-BIKN2-E	RC-E5 RC-EX3A
FDTC VH1, VH, VF FDT VH FDUM VH FDU VH FDE VH FDF VH	not required	



WI-FI CONTROL

WI-FI CONTROL SYSTEM FOR SRK, SRR, SRF UNITS

Thanks to the Smart M-Air app it is possible to have the remote control of your air conditioner always with you, conveniently on your smartphone and/or tablet.

The Wi-Fi control allows you to set the ideal climate in your home, even while away from home, thus generating the right comfort when you come back.

EXAMPLE OF SCREEN



Available for iOS
smartphone and
tablet



Available
for Android
smartphone and
tablet



MAIN FUNCTIONS OF THE APP

- On & Off control.
- Adjustment of the set temperature.
- Selection of operation mode.
- Fan speed.
- Flaps' control.
- Room temperature control.
- Multilanguage.
- Weekly timer with 6 daily settings.
- Yearly timer with specific day settings.
- High/low room temperature warning function; temperature limits can be set to be informed when they are exceeded inside the air-conditioned room.
- High and low temperature control function: by this function the system automatically reactivates operation once the set temperature limits are exceeded.
- Cooling only operation block.
- Consumption control function in kW/h with monthly graph and economic quantification of consumption in euros.
- Error detection and description.
- Auto updates of the App.



WI-FI CONTROL

INWFIUNI001I000 Universal Wi-Fi interface for all models of indoor units

INWFMHI001R100 Wi-Fi interface for Light Commercial, PAC & VRF indoor units (excluding SRK models)

HOME AIR CONDITIONING CONTROL, EVEN FROM OUTSIDE YOUR HOME

Termal presents the new Wi-Fi Intesis AC Cloud module which allows access to remote air conditioner control through a downloadable smartphone app.

Thanks to the Intesis AC Cloud App, it is possible to manage the main operating parameters from your home with a simple Wi-Fi home connection, or away from home, with a simple Internet connection.

The Intesis AC Cloud App allows you to individually and uniquely control different internal units, effectively regulating the air conditioning of multiple rooms.

EXAMPLE OF SCREEN AND CONNECTION DIAGRAM



Available for iOS smartphone and tablet



Available for Android smartphone and tablet



MAIN FUNCTIONS OF THE APP

- On & Off control.
- Adjustment of the set temperature.
- Selection of operation mode.
- Fan speed.
- Flaps' control.
- Room temperature control.
- Timer.
- 26 different languages.
- Anti-frost mode setting for overheat.
- Error detection and description.
- Auto updates of the App.
- Filter cleaning.
- Calendar.
- 3 mobile devices can control a single unit.
- Room presence detector.
- Energy Saving function.

COMPATIBLE WITH THIRD-PARTY VOICE CONTROLLED SYSTEMS



OPTIONAL CONTROLS

CENTRALIZED CONTROLS

CENTRALIZED CONTROL PANEL SC-SL4-AE3/BE3

MHI introduces SC-SL4-AE3/BE3, the new centralized control with 9" interactive (Full Color Touch) LCD display.

Users can perform monitoring, programming and maintenance from the panel.

It can control up to 128 indoor units.

Users can connect with a PC or tablet through an Internet Explorer (IPad, Windows) WEB interface.



ALL THE FUNCTIONS OF THE NEW VERSION

The indoor units can be programmed, monitored and interrogated individually, in groups, and in blocks of groups with the following functions:

Control	Monitoring	Scheduling	Management/Service
ON/OFF	Operating status	Annual scheduling	Definition of blocks
Modes cool/heat/fan/dry/Auto	Mode	Daily scheduling	Groups' definition
T° setting	Temperature settings	Special days' scheduling	Unit's definition
Permitted/prohibited operations	Ambient temperature	Seasonal scheduling	Date & Hour setting
Fan speed	Permitted/prohibited operations		Alarm history
Air direction	Fan speed		Consumption calculation period
Filter signal reset	Air direction		Cumulative operating time
Request control (3 steps)	Filter signal		Energy consumption
Emergency stop	Maintenance		
	Request control		

ELECTRICAL CONSUMPTION CALCULATION FUNCTION (SC-SL4-BE3 ONLY)

SC-SL4-BE3 is able to monitor electrical consumption in kW/h for each indoor unit in a single group on the Superlink system, using a USB memory.

	SC-SL4-BE3
Data export method	USB
Calculation software	Included
Number of inputs for pulse detector (wattmeter)	8
Connectable units (MAX)	128 (Superlink II)

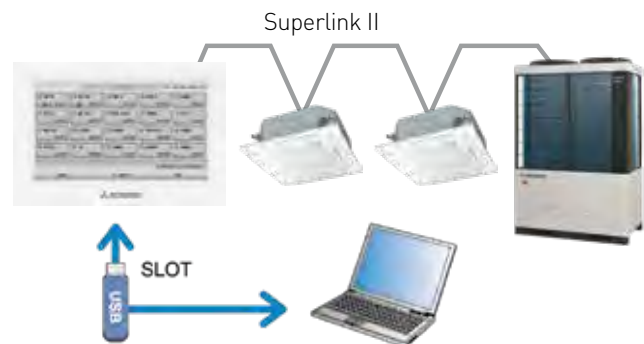

Model	SC-SL4-AE3/SC-SL4-BE3	
Ambient temperature	°C	0° C ~ 40° C
Power supply		1-Phase 100-240V 50/60Hz
Consumption	W	18
Dimensions (H x L x P)	mm	172x250x23(+70)
Net weight	kg	2.00
Nb. of connectable I.U.	nb.	128 (Superlink II) / 144 (Supelink I)
LCD touch panel		LCD color, 9"
Superlink input		1 (Superlink II) / 3 (Superlink I)

OPTIONAL CONTROLS

CENTRALIZED CONTROLS

CENTRALIZED CONTROL PANEL SC-SL2NA-E

The SC-SL2NA-E panel is connected to the Superlink II system via a non-polarised 2-wire cable. It enables the user to start up/stop and monitor up to 16 groups simultaneously, for a total of 64 units. It also monitors and controls the following functions for each unit, group of units or for the whole network: temperature setting, position of the louvers, operating errors. The number of units in operation can be seen on the LCD, as can those that require assistance. The timer facilitates the power on and power off cycles. The panel can be connected at any point in the Superlink II network, to both indoor and outdoor units, reducing the length of the wiring used for the connections.



CENTRALIZED CONTROL PANEL SC-SL1N-E

The SC-SL1N-E panel is connected to the Superlink II system via a non-polarised 2-wire cable. It enables the user to start up/stop and monitor up to 16 indoor units simultaneously. The number of units in operation can be seen on the special LEDs, as can those that require assistance. In the context of a Superlink II system, up to 12 SC-SL1N-E panels can coexist, for a total of 128 indoor units controlled.



DEVICES FOR CONTROLLING THE SUPERLINK II NETWORK

LONWORKS GATEWAY SC-LGWNB

This platform enables users to connect and centrally control the indoor units, converting the LonWorks communication data into Superlink II communication data. Up to 96 units can be controlled, the highest number possible for the LON systems on the market.



WEB GATEWAY + BACNET GATEWAY SC-WBGW256

This platform makes a simple monitoring system possible for small and medium-sized installations: it includes metering functions and enables users to control up to 256 indoor units (96 groups - 128 indoor units on 2 Superlink II networks).

Safe and easy: all you need is Internet Explorer, without using any additional software. Using a filter on the IP address, the system lets users select and limit access to the platform through 3 different levels of account authentication.

Integrated metering function.



CONTROLS

SUPERLINK II

THE ADVANCED FAST DATA TRANSMISSION SYSTEM

Superlink II is able to connect up to 128 indoor units and 32 outdoor units on a network.

It is a centralized control system that meets the different needs of large, medium and small buildings. The implementation of the Superlink II system greatly reduces installation costs by reducing the size of the wiring area using a non-polarised 2-wire cable. In order to harmonise air conditioning and its management, Mitsubishi Heavy Industries also offers a wide range of controls and instruments for a reliable control system. Easy access can thus be made for computerised management of the building to be air-conditioned, guaranteeing the highest standard on the market in a fully affordable system.

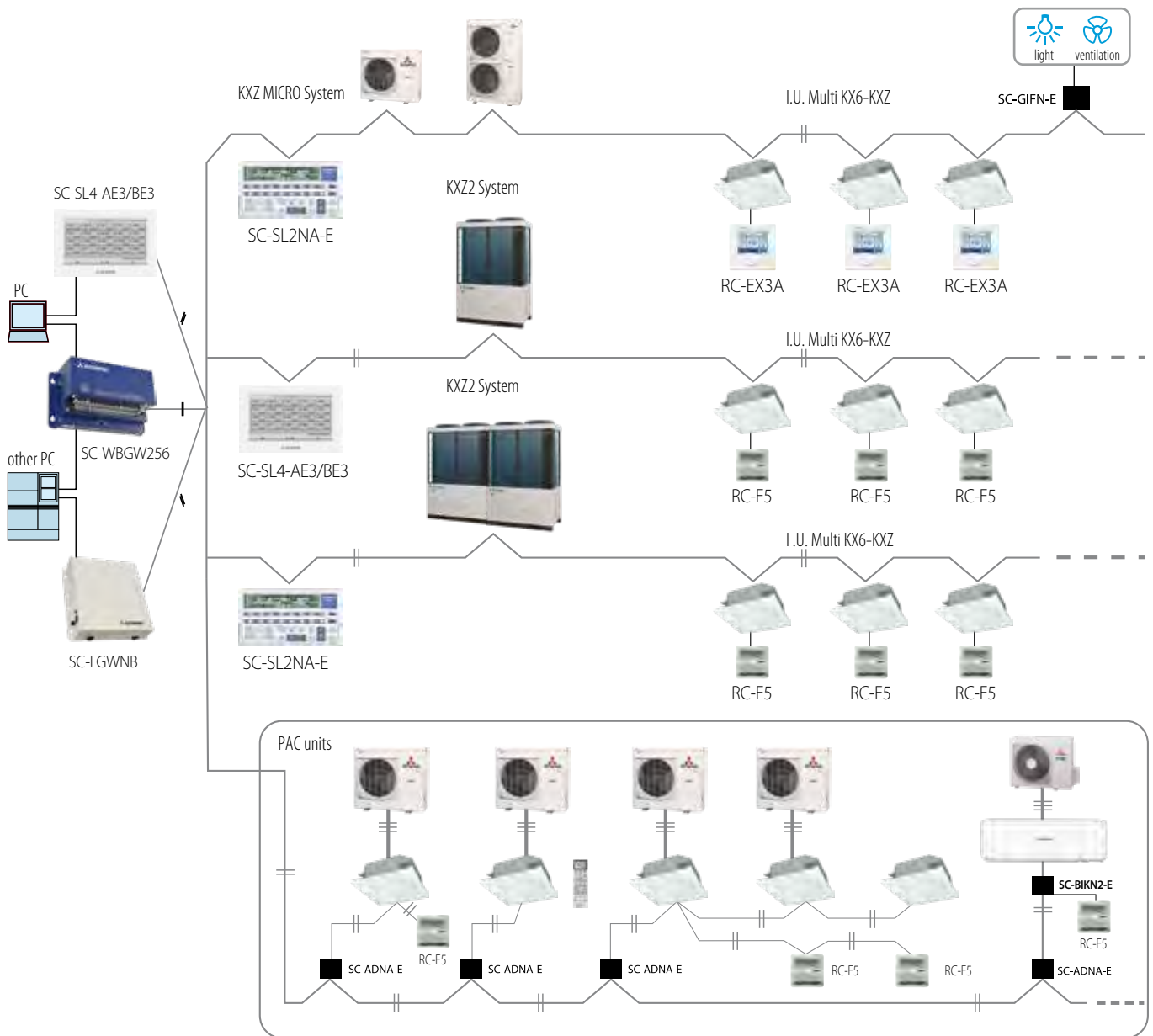

CONTROLS

SUPERLINK II

OPTIONAL KIT SC-BIKN2-E

This interface card makes it possible to create a 2-wire X, Y network on units (SRK, SRR, SRF), enabling management using the RC-E5 wired remote control. Furthermore, using the SC-ADNA-E card connected directly to the SC-BIKN2-E card, it is possible to connect the unit to the Superlink II network and centralise management the units (SRK, SRR, SRF) using remote controls for all functions. The interface card is contained in a box fastened to the wall measuring 120x135x29 mm. The card is also equipped with a CnT connector, which enables the units (SRK, SRR, SRF) to exchange the digital inputs/outputs with an external control.

OPTIONAL KIT SC-GIFN-E

The SC-GIFN-E interface card connected to the centralised Mitsubishi SC-SL1N-E, SC-SL2NA-E and SC-SL4-AE3/BE3 control systems, lets you control the switching on and off of other equipment, including non-Mitsubishi devices (telephone dialler, home automation systems, etc.).

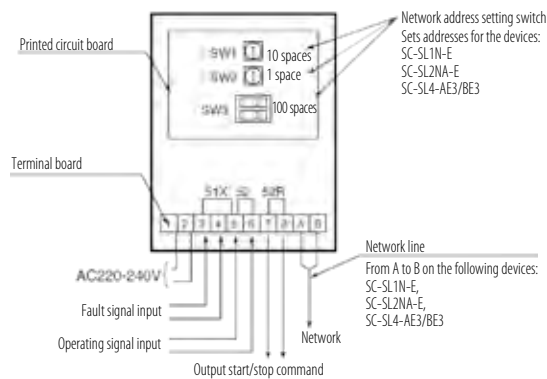

SCHEME OF USE OF DIGITAL INTERFACES

Superlink II connection

Model	Interface	Controls
SRK ZSX-S(T) SRK ZS-S(T) SRK ZR-S SRF ZMX-S SRR ZM-S SRR 25~60 ZM-S	SC-BIKN2-E SC-ADNA-E	RC-E5 RC-EX3A Centralized
FD unit (no KX)	SC-ADNA-E	Centralized

Wired control connection

Model	Interface	Controls
SRK ZSX-S(T) SRK ZS-S(T) SRK ZR-S SRF ZMX-S SRR ZM-S	SC-BIKN2-E	RC-EX3A RC-E5

M-ACCESS

RM-CGW-E1

Management interface via M-ACCESS: this is a remote monitoring system for MHI products that adopts Cloud-type Gateway equipment and which allows centralized management of air conditioning systems from multiple remote locations using the Internet of Things (IoT) .

You can easily monitor and manage the status of external and internal drives via the Internet using, for example, a PC or tablet.

Some of the available functions are as follows:

- real-time monitoring of machines;
- management of operating parameters (on/off, mode, temperature and fan speed);
- electricity consumption and alarm notifications via email.

All MHI residential, commercial, VRF and Q-ton products (with the necessary interface cards) can be connected to this new and innovative system.





HOME AND BUILDING AUTOMATION

INTESIS - INTERFACCE BMS

KNX

By means of the INKNXMHI001R000, INKNXUNI001I000 and IN776MHIO0S0000, IN776MHIO0M0000, IN776MHIO0L0000 interfaces, it is possible to integrate Mitsubishi Heavy Industries units with supervision that uses the KNX standard.



Example of integration of a light commercial unit with individual control

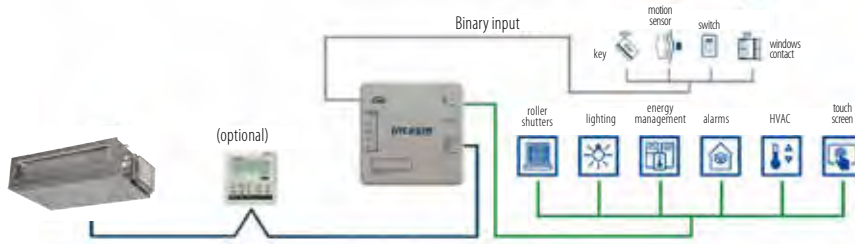

INKNXMHI001R000



NEW



IN776MHIO0S0000
IN776MHIO0M0000
IN776MHIO0L0000

MODBUS

By means of the INBMSMHI001R000, IN485UNI001I000 and IN776MHIO0S0000, IN776MHIO0M0000, IN776MHIO0L0000 interfaces, it is possible to integrate Mitsubishi Heavy Industries units with supervision that uses the Modbus standard.



Example of integration of a light commercial unit with individual control



INBMSMHI001R000

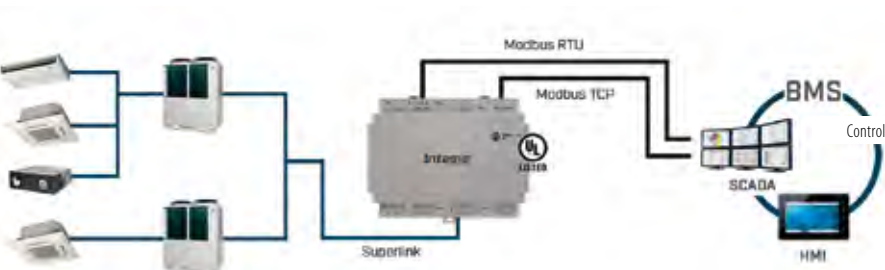

NEW



IN776MHIO0S0000
IN776MHIO0M0000
IN776MHIO0L0000

HOME AND BUILDING AUTOMATION

INTESIS - INTERFACCE BMS

BACNET

The BACnet Gateways INBACMH1001R000, IN485UNI001I000 and IN776MH100S0000, IN776MH100M0000, IN776MH100L0000 allow two-way communication between Mitsubishi Heavy Industries Commercial and VRF units and BACnet IP and BACnet MS/TP or BACnet MS/TP only networks, respectively.



BACNET MS/TP NETWORK

Example of integration of a commercial unit with individual control

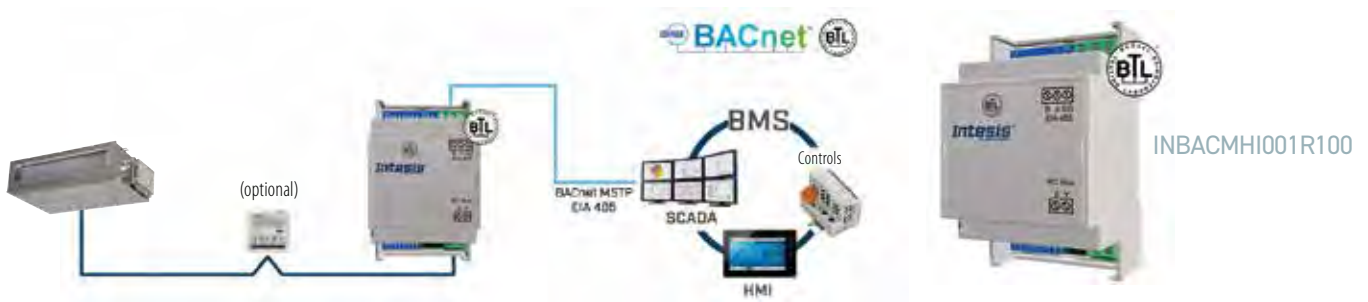

BACNET MS/TP & BACNET IP NETWORK

Example of integration of a commercial unit with individual control

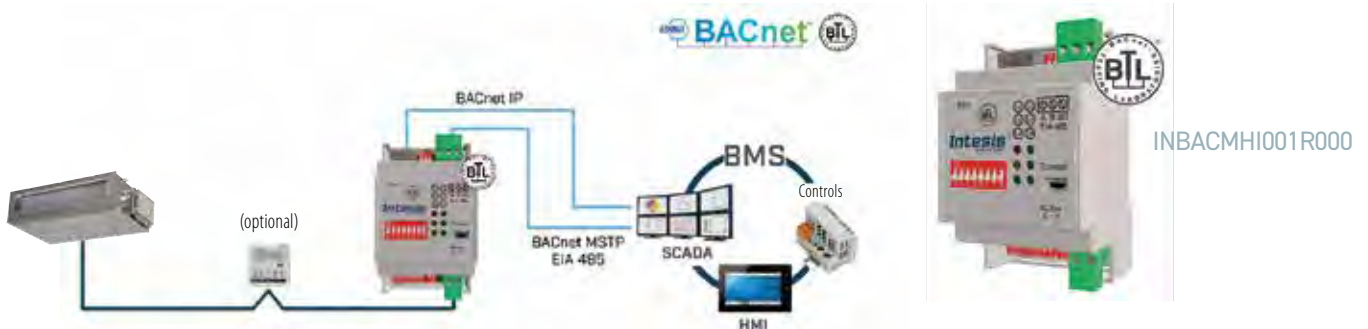

BACNET MS/TP NETWORK

Example of integration of a commercial unit with individual control

NEW

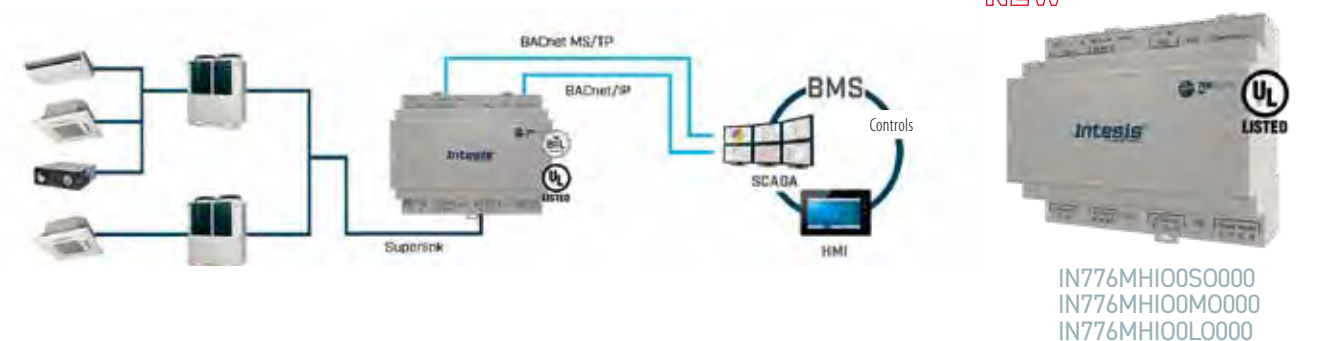

IN776MH100S0000
IN776MH100M0000
IN776MH100L0000

ICON KEY

ENERGY SAVING

FUZZY AUTO OPERATION



The unit automatically determines the operating mode and temperature setting based on fuzzy calculation by adjusting the frequency of the Inverter.

HUMAN SENSOR



This sensor detects the activity and movement of people present in the environment, inhibiting the operation of the unit when it is not necessary.

ECO MODE



The temperature and humidity in the environment are monitored, using a sensor that automatically controls the operation. In combination with the motion sensor, the system enables an energy saving mode ensuring that comfort is maintained.

AUTO-OFF



If the air conditioner does not detect the presence of any activity by people in the room for a certain period of time, operation is automatically stopped.

ECONOMIC MODE



The unit carries out an effective energy saving operation, while maintaining comfort in cooling and heating at the same time.

AIRFLOW

JET AIR



Aviation technology is used to design the components of the air flow system of the air conditioner.

3D AUTO



By pressing a single button, you can choose the optimal 3D cooling/heating mode.

AUTOMATIC SELECTION OF FLAPS' MOVEMENT



In any operating mode, the unit automatically selects the optimal angle of the air diffusion fin.

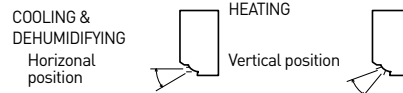

FLAP POSITION MEMORY



In any operating mode, the unit automatically selects the optimal angle of the air diffusion louver.

VERTICAL SWINGING OF FLAPS



The air outlet flap moves continuously from top to bottom and vice versa. The up/down swing of the flap can be fixed at the desired operating angle.

HORIZONTAL SWINGING OF FLAPS



The air deflector moves continuously from left to right and vice versa. The swing of the right/left flap can be fixed at the desired operating angle.

AIR DRAFT PREVENTION SETTING



This function can be used via the remote control in both cooling and heating modes. This allows for a homogeneous and accurately assistive air flow out of the indoor unit.

FILTERS AND SANITIZATION

ALLERGEN CLEAR FUNCTION



The system is equipped with an allergen elimination function: the filter captures allergens, controlling temperature and humidity.

SELF CLEAN FUNCTION



Once the unit has finished operating, the automatic cleaning procedure starts and continues for 2 hours. The function involves drying the internal unit and prevents the formation of mould.

ALLERGEN CLEAR FILTER



The filter neutralizes pollen and all parasites that live on the skin of animals, eliminating all allergens.

PHOTOCATALYTIC FILTER



The filter keeps the air clean by deodorizing the molecules that cause bad odors. The deodorizing capacity can be easily restored by simply washing the filter and exposing it to sunlight.

REMOVABLE PANEL



Maintenance is easy, as the front panel can be easily removed for trouble-free cleaning and maintenance.

ICON KEY

COMFORT

DEHUMIDIFICATION



The unit dehumidifies the room through an intermittent cooling operation.

HIGH POWER FUNCTION



The unit is capable of operating in enhanced "HI POWER" mode for 15 consecutive minutes. This mode is useful for reaching the desired temperature quickly.

SILENT FUNCTION



The sound level of the outdoor units is at least 3 dB(A) lower than the nominal level.

NIGHT FUNCTION



During cold seasons, temperatures can be maintained at a comfortable level even when there are no people inside the room. The air conditioner maintains the temperature at 10° C.

FIREPLACE FUNCTION



The fan continues to operate when the room temperature is constant, the warm air accumulated at the top is kept circulating in the room.

WEEKLY TIMER



For each day of the week, up to 4 timer programming (ON-TIMER/OFF-TIMER) are available. It is possible to set MAX 28 schedules per week.

PROGRAMMABLE TIMER 24 HOURS



By combining a Start Timer with a Stop Timer, you can record two Timer selections per day. Once set, the Timers will faithfully start and stop the system at the scheduled time, repeating the operation every day.

TIMER SLEEP



During the Sleep mode setting period, the room temperature is automatically controlled, so that it neither feels excessively cold nor excessively hot.

TIMER ON/OFF



Unit operation will start and stop at the set time.

COMFORT START-UP



In ON-TIMER operation, the unit automatically starts operation a little earlier, so that the room can approach the optimal temperature at the time set for start.

PRE-SET FUNCTION



By simply pressing a button, you can activate the pre-set operating mode.

CHILD LOCK



Button lock function, to prevent tampering and inadvertent operations. This feature is useful for families with small children.

LED INTENSITY ADJUSTMENT



The brightness of the LED display can be adjusted according to your needs.

INSTALLATION POSITION



If the air conditioner is installed near the side wall, you can set the left-right air flow directions using the remote controller.

WI-FI MODULE



With the wireless device, you can control the air conditioner at home or on the go by installing the Smart M-Air app on your smartphone or tablet.

OTHER FUNCTIONS

DEFROST FUNCTION



This mode automatically eliminates frost, minimizing excessive operation in other modes.

SELF-DIAGNOSIS FUNCTION



In case of malfunctions of the air conditioner, an internal microprocessor automatically performs a self-diagnosis (inspection and repair must be carried out by the Authorized Technical Service).

AUTORESTART FUNCTION



The automatic restart after power failure function is a function that records the operating conditions of the air conditioner immediately before the blackout, so that the same settings are restored when the power supply returns.

BACKUP FUNCTION



On the main unit, there is a backup/off button, which is useful when you can't use the remote control, or because the batteries are low.



PERFORMANCE
TABLES MULTISPLIT
R32

PERFORMANCE TABLES MULTISPLIT R32

SCM 30 ZS-W

HEATING		Seasonal energy efficiency	COP	Heating capacity (kW)					Power input (W)			Rated current (A)		
				Capacity for each room (kW)		Total capacity (kW)			Min.	Standard	Max.	220V	230V	240V
		A		B	Min.	Standard	Max.							
1 unit	15		3.92	2.0	-	1.0	2.0	3.2	250	510	940	2.4	2.3	2.2
	20		3.85	3.0	-	1.0	3.0	4.3	250	780	1260	3.7	3.6	3.4
	25		3.74	3.4	-	1.0	3.4	4.5	250	910	1310	4.4	4.2	4.0
2 units	15 + 15	4.80	5.41	2.00	2.00	1.1	4.0	5.7	250	740	1490	3.5	3.4	3.2
	15 + 20	4.80	5.41	1.71	2.29	1.1	4.0	5.7	250	740	1490	3.5	3.4	3.2
	15 + 25	4.80	5.41	1.50	2.50	1.1	4.0	5.7	250	740	1490	3.5	3.4	3.2
	20 + 20	4.80	5.41	2.00	2.00	1.1	4.0	5.7	250	740	1490	3.5	3.4	3.2
	20 + 25	4.80	5.41	1.78	2.22	1.1	4.0	5.7	250	740	1490	3.5	3.4	3.2
	25 + 25	4.80	5.41	2.00	2.00	1.1	4.0	5.7	250	740	1490	3.5	3.4	3.2

SCOP = EU Regulation N. 206/2012 – Value measured in according to harmonized rule EN14825.
COP = Value measured in according to harmonized rule EN 14511.

COOLING		Seasonal energy efficiency	EER	Cooling capacity (kW)					Power input (W)			Rated current (A)		
				Capacity for each room (kW)		Total capacity (kW)			Min.	Standard	Max.	220V	230V	240V
		A		B	Min.	Standard	Max.							
1 unit	15		4.29	1.50	-	1.4	1.5	2.2	320	350	710	1.8	1.7	1.6
	20		3.92	2.00	-	1.4	2.0	2.9	320	510	930	2.6	2.5	2.4
	25		3.52	2.50	-	1.4	2.5	3.1	320	710	990	3.6	3.5	3.3
2 units	15 + 15	8.60	5.77	1.50	1.50	1.6	3.0	4.4	320	520	1280	2.7	2.5	2.4
	15 + 20	8.60	5.77	1.29	1.71	1.6	3.0	4.9	320	520	1520	2.7	2.5	2.4
	15 + 25	8.60	5.77	1.13	1.88	1.6	3.0	5.0	320	520	1600	2.7	2.5	2.4
	20 + 20	8.60	5.77	1.50	1.50	1.6	3.0	5.0	320	520	1600	2.7	2.5	2.4
	20 + 25	8.60	5.77	1.33	1.67	1.6	3.0	5.0	320	520	1600	2.7	2.5	2.4
	25 + 25	8.60	5.77	1.50	1.50	1.6	3.0	5.0	320	520	1600	2.7	2.5	2.4

SEER = EU Regulation N. 206/2012 – Value measured in according to harmonized rule EN14825.
EER = Value measured in according to harmonized rule EN 14511.

SCM 40 ZS-W

HEATING		Seasonal energy efficiency	COP	Heating capacity (kW)					Power input (W)			Rated current (A)		
				Capacity for each room (kW)		Total capacity (kW)			Min.	Standard	Max.	220V	230V	240V
		A		B	Min.	Standard	Max.							
1 unit	20		4.41	3.0	-	1.0	3.0	4.5	250	680	1140	3.2	3.1	3.0
	25		4.30	3.4	-	1.0	3.4	4.9	250	790	1270	3.7	3.5	3.4
	35		3.95	4.5	-	1.0	4.5	5.4	250	1140	1470	5.3	5.1	4.8
2 units	20 + 20	4.70	5.42	2.25	2.25	1.2	4.5	6.3	250	830	1480	3.8	3.7	3.5
	20 + 25	4.70	5.42	2.00	2.50	1.2	4.5	6.3	250	830	1480	3.8	3.7	3.5
	20 + 35	4.70	5.42	1.64	2.86	1.2	4.5	6.3	250	830	1480	3.8	3.7	3.5
	25 + 25	4.70	5.42	2.25	2.25	1.2	4.5	6.3	250	830	1480	3.8	3.7	3.5
	25 + 35	4.70	5.42	1.88	2.63	1.2	4.5	6.3	250	830	1480	3.8	3.7	3.5

SCOP = EU Regulation N. 206/2012 – Value measured in according to harmonized rule EN14825.
COP = Value measured in according to harmonized rule EN 14511.

COOLING		Seasonal energy efficiency	EER	Cooling capacity (kW)					Power input (W)			Rated current (A)		
				Capacity for each room (kW)		Total capacity (kW)			Min.	Standard	Max.	220V	230V	240V
		A		B	Min.	Standard	Max.							
1 unit	20		4.65	2.00	-	1.5	2.0	3.4	340	430	930	2.2	2.1	2.0
	25		4.17	2.50	-	1.5	2.5	3.8	340	600	1110	3.0	2.9	2.8
	35		3.50	3.50	-	1.5	3.5	4.5	340	1000	1470	4.7	4.5	4.3
2 units	20 + 20	9.10	5.00	2.00	2.00	1.7	4.0	5.9	340	800	2100	3.7	3.5	3.4
	20 + 25	9.10	5.00	1.78	2.22	1.7	4.0	5.9	340	800	2100	3.7	3.5	3.4
	20 + 35	9.10	5.00	1.45	2.55	1.7	4.0	5.9	340	800	2100	3.7	3.5	3.4
	25 + 25	9.10	5.00	2.00	2.00	1.7	4.0	5.9	340	800	2100	3.7	3.5	3.4
	25 + 35	9.10	5.00	1.67	2.33	1.7	4.0	5.9	340	800	2100	3.7	3.5	3.4

SEER = EU Regulation N. 206/2012 – Value measured in according to harmonized rule EN14825.
EER = Value measured in according to harmonized rule EN 14511.

PERFORMANCE TABLES MULTISPLIT R32

SCM 45 ZS-W

HEATING		Seasonal energy efficiency	COP	Heating capacity (kW)					Power input (W)			Rated current (A)		
				Capacity for each room (kW)		Total capacity (kW)			Min.	Standard	Max.	220V	230V	240V
1 unit	20		4.41	3.00	-	1.0	3.0	4.5	250	680	1140	3.2	3.1	3.0
	25		4.30	3.40	-	1.0	3.4	4.9	250	790	1270	3.7	3.5	3.4
	35		3.95	4.50	-	1.0	4.5	5.4	250	1140	1470	5.3	5.1	4.8
2 units	20 + 20		5.42	2.25	2.25	1.2	4.5	6.5	250	830	1480	3.8	3.7	3.5
	20 + 25	4.70	5.00	2.36	2.94	1.2	5.3	6.5	250	1060	1480	4.9	4.7	4.5
	20 + 35	4.70	5.00	1.93	3.37	1.2	5.3	6.5	250	1060	1480	4.9	4.7	4.5
	25 + 25	4.70	5.00	2.65	2.65	1.2	5.3	6.5	250	1060	1480	4.9	4.7	4.5
	25 + 35	4.70	5.00	2.21	3.09	1.2	5.3	6.5	250	1060	1480	4.9	4.7	4.5
	35 + 35	4.70	5.00	2.65	2.65	1.2	5.3	6.5	250	1060	1480	4.9	4.7	4.5

SCOP = EU Regulation N. 206/2012 – Value measured in according to harmonized rule EN14825.

COP = Value measured in according to harmonized rule EN 14511.

COOLING		Seasonal energy efficiency	EER	Cooling capacity (kW)					Power input (W)			Rated current (A)		
				Capacity for each room (kW)		Total capacity (kW)			Min.	Standard	Max.	220V	230V	240V
1 unit	20		4.65	2.00	-	1.5	2.0	3.4	340	430	930	2.2	2.1	2.0
	25		4.17	2.50	-	1.5	2.5	3.8	340	600	1110	3.0	2.9	2.8
	35		3.50	3.50	-	1.5	3.5	4.5	340	1000	1470	4.7	4.5	4.3
2 units	20 + 20		4.65	2.00	2.00	1.7	4.0	6.2	340	860	2100	4.0	3.8	3.7
	20 + 25	9.10	4.69	2.00	2.50	1.7	4.5	6.4	340	960	2300	4.5	4.3	4.1
	20 + 35	9.10	4.69	1.64	2.86	1.7	4.5	6.4	340	960	2300	4.5	4.3	4.1
	25 + 25	9.10	4.69	2.25	2.25	1.7	4.5	6.4	340	960	2300	4.5	4.3	4.1
	25 + 35	9.10	4.69	1.88	2.63	1.7	4.5	6.4	340	960	2300	4.5	4.3	4.1
	35 + 35	9.10	4.69	2.25	2.25	1.7	4.5	6.4	340	960	2300	4.5	4.3	4.1

SEER = EU Regulation N. 206/2012 – Value measured in according to harmonized rule EN14825.

EER = Value measured in according to harmonized rule EN 14511.

SCM 41 ZS-W

HEATING		Seasonal energy efficiency	COP	Heating capacity (kW)						Power input (W)			Rated current (A)			
				Capacity for each room (kW)				Total capacity (kW)		Min.	Standard	Max.	220V	230V	240V	
				A	B	C	D	Min.	Standard							Max.
1 unit	15		3.64	2.00	-	-	-	1.0	2.0	3.2	250	550	990	2.6	2.5	2.4
	20		3.45	3.00	-	-	-	1.0	3.0	4.3	250	870	1330	4.1	3.9	3.8
	25		3.37	3.40	-	-	-	1.0	3.4	4.5	250	1010	1390	4.8	4.6	4.4
	35		3.24	4.50	-	-	-	1.0	4.5	5.0	250	1390	1550	6.6	6.3	6.0
2 units	15 + 15	4.50	4.86	1.70	1.70	-	-	1.1	3.4	6.6	250	700	1580	3.3	3.2	3.0
	15 + 20	4.50	4.64	1.67	2.23	-	-	1.1	3.9	6.6	250	840	1580	4.0	3.8	3.6
	15 + 25	4.50	4.41	1.69	2.81	-	-	1.1	4.5	6.6	250	1020	1580	4.8	4.6	4.4
	15 + 35	4.50	4.41	1.35	3.15	-	-	1.1	4.5	6.6	250	1020	1580	4.8	4.6	4.4
	20 + 20	4.50	4.41	2.25	2.25	-	-	1.1	4.5	6.6	250	1020	1580	4.8	4.6	4.4
	20 + 25	4.50	4.41	2.00	2.50	-	-	1.1	4.5	6.6	250	1020	1580	4.8	4.6	4.4
	20 + 35	4.50	4.41	1.64	2.86	-	-	1.1	4.5	6.6	250	1020	1580	4.8	4.6	4.4
	25 + 25	4.50	4.41	2.25	2.25	-	-	1.1	4.5	6.6	250	1020	1580	4.8	4.6	4.4
	25 + 35	4.50	4.41	1.88	2.63	-	-	1.1	4.5	6.6	250	1020	1580	4.8	4.6	4.4
	35 + 35	4.50	4.41	2.25	2.25	-	-	1.1	4.5	6.6	250	1020	1580	4.8	4.6	4.4
3 units	15 + 15 + 15	4.60	5.56	1.50	1.50	1.50	-	1.2	4.5	6.9	250	810	1580	3.8	3.7	3.5
	15 + 15 + 20	4.60	5.56	1.35	1.35	1.80	-	1.2	4.5	6.9	250	810	1580	3.8	3.7	3.5
	15 + 15 + 25	4.60	5.56	1.23	1.23	2.05	-	1.2	4.5	6.9	250	810	1580	3.8	3.7	3.5
	15 + 15 + 35	4.60	5.56	1.04	1.04	2.42	-	1.2	4.5	6.9	250	810	1580	3.8	3.7	3.5
	15 + 20 + 20	4.60	5.56	1.23	1.64	1.64	-	1.2	4.5	6.9	250	810	1580	3.8	3.7	3.5
	15 + 20 + 25	4.60	5.56	1.13	1.50	1.88	-	1.2	4.5	6.9	250	810	1580	3.8	3.7	3.5
	15 + 20 + 35	4.60	5.56	0.96	1.29	2.25	-	1.2	4.5	6.9	250	810	1580	3.8	3.7	3.5
	20 + 20 + 20	4.60	5.56	1.50	1.50	1.50	-	1.2	4.5	6.9	250	810	1580	3.8	3.7	3.5
	20 + 20 + 25	4.60	5.56	1.38	1.38	1.73	-	1.2	4.5	6.9	250	810	1580	3.8	3.7	3.5
	20 + 25 + 25	4.60	5.56	1.29	1.61	1.61	-	1.2	4.5	6.9	250	810	1580	3.8	3.7	3.5

SCOP = EU Regulation N. 206/2012 – Value measured in according to harmonized rule EN14825.

COP = Value measured in according to harmonized rule EN 14511.

PERFORMANCE TABLES MULTISPLIT R32

SCM 41 ZS-W

COOLING		Seasonal energy efficiency	EER	Cooling capacity (kW)							Power input (W)			Rated current (A)		
				Capacity for each room (kW)				Total capacity (kW)			Min.	Standard	Max.	220V	230V	240V
		Combined units		SEER	A	B	C	D	Min.	Standard						
1 unit	15		4.17	1.50	-	-	-	1.4	1.5	2.2	320	360	740	1.7	1.6	1.6
	20		3.77	2.00	-	-	-	1.4	2.0	2.9	320	530	970	2.5	2.4	2.3
	25		3.42	2.50	-	-	-	1.4	2.5	3.1	320	730	1040	3.5	3.3	3.2
	35		3.13	3.50	-	-	-	1.4	3.5	4.0	320	1120	1330	5.4	5.1	4.9
2 units	15 + 15	8.40	5.45	1.50	1.50	-	-	1.5	3.0	4.9	320	550	1400	2.6	2.5	2.4
	15 + 20	8.40	5.00	1.50	2.00	-	-	1.5	3.5	5.5	320	700	1600	3.3	3.2	3.1
	15 + 25	8.40	4.40	1.50	2.50	-	-	1.5	4.0	5.7	320	910	1650	4.4	4.2	4.0
	15 + 35	8.40	4.40	1.20	2.80	-	-	1.5	4.0	5.7	320	910	1650	4.4	4.2	4.0
	20 + 20	8.40	4.40	2.00	2.00	-	-	1.5	4.0	5.7	320	910	1650	4.4	4.2	4.0
	20 + 25	8.40	4.40	1.78	2.22	-	-	1.5	4.0	5.7	320	910	1650	4.4	4.2	4.0
	20 + 35	8.40	4.40	1.45	2.55	-	-	1.5	4.0	5.7	320	910	1650	4.4	4.2	4.0
	25 + 25	8.40	4.40	2.00	2.00	-	-	1.5	4.0	5.7	320	910	1650	4.4	4.2	4.0
	25 + 35	8.40	4.40	1.67	2.33	-	-	1.5	4.0	5.7	320	910	1650	4.4	4.2	4.0
35 + 35	8.40	4.40	2.00	2.00	-	-	1.5	4.0	5.7	320	910	1650	4.4	4.2	4.0	
3 units	15 + 15 + 15	9.20	5.56	1.33	1.33	1.33	-	1.6	4.0	6.3	320	720	1650	3.4	3.3	3.2
	15 + 15 + 20	9.20	5.56	1.20	1.20	1.60	-	1.6	4.0	6.3	320	720	1650	3.4	3.3	3.2
	15 + 15 + 25	9.20	5.56	1.09	1.09	1.82	-	1.6	4.0	6.3	320	720	1650	3.4	3.3	3.2
	15 + 15 + 35	9.20	5.56	0.92	0.92	2.15	-	1.6	4.0	6.3	320	720	1650	3.4	3.3	3.2
	15 + 20 + 20	9.20	5.56	1.09	1.45	1.45	-	1.6	4.0	6.3	320	720	1650	3.4	3.3	3.2
	15 + 20 + 25	9.20	5.56	1.00	1.33	1.67	-	1.6	4.0	6.3	320	720	1650	3.4	3.3	3.2
	15 + 20 + 35	9.20	5.56	0.86	1.14	2.00	-	1.6	4.0	6.3	320	720	1650	3.4	3.3	3.2
	20 + 20 + 20	9.20	5.56	1.33	1.33	1.33	-	1.6	4.0	6.3	320	720	1650	3.4	3.3	3.2
	20 + 20 + 25	9.20	5.56	1.23	1.23	1.54	-	1.6	4.0	6.3	320	720	1650	3.4	3.3	3.2
20 + 25 + 25	9.20	5.56	1.14	1.43	1.43	-	1.6	4.0	6.3	320	720	1650	3.4	3.3	3.2	

SEER = EU Regulation N. 206/2012 – Value measured in according to harmonized rule EN14825.

EER = Value measured in according to harmonized rule EN 14511.

SCM 50 ZS-W

HEATING		Seasonal energy efficiency	COP	Heating capacity (kW)							Power input (W)			Rated current (A)		
				Capacity for each room (kW)				Total capacity (kW)			Min.	Standard	Max.	220V	230V	240V
		Combined units		SCOP	A	B	C	D	Min.	Standard						
1 unit	20		3.85	3.00	-	-	-	1.0	3.0	3.7	320	780	1100	3.6	3.5	3.3
	25		3.58	3.40	-	-	-	1.0	3.4	4.2	320	950	1240	4.4	4.2	4.0
	35		3.54	4.50	-	-	-	1.0	4.5	5.0	320	1270	1490	5.9	5.6	5.4
	50		3.39	5.80	-	-	-	1.0	5.8	6.5	320	1710	2310	7.9	7.6	7.3
2 units	20+20		5.14	2.70	2.70	-	-	1.2	5.4	7.3	290	1050	2500	4.9	4.7	4.5
	20+25		5.00	2.62	3.28	-	-	1.2	5.9	7.3	290	1180	2500	5.5	5.2	5.0
	20+35	4.70	5.00	2.18	3.82	-	-	1.2	6.0	7.3	290	1200	2500	5.6	5.3	5.1
	20+50	4.70	5.00	1.71	4.29	-	-	1.2	6.0	7.3	290	1200	2500	5.6	5.3	5.1
	25+25	4.70	5.00	3.00	3.00	-	-	1.2	6.0	7.3	290	1200	2500	5.6	5.3	5.1
	25+35	4.70	5.00	2.50	3.50	-	-	1.2	6.0	7.3	290	1200	2500	5.6	5.3	5.1
	25+50	4.70	5.00	2.00	4.00	-	-	1.2	6.0	7.3	290	1200	2500	5.6	5.3	5.1
	35+35	4.70	5.00	3.00	3.00	-	-	1.2	6.0	7.3	290	1200	2500	5.6	5.3	5.1
	35+50	4.70	5.00	2.47	3.53	-	-	1.2	6.0	7.3	290	1200	2500	5.6	5.3	5.1
3 units	20+20+20	4.60	5.17	2.00	2.00	2.00	-	1.4	6.0	7.5	270	1160	2500	5.4	5.1	4.9
	20+20+25	4.60	5.17	1.85	1.85	2.31	-	1.4	6.0	7.5	270	1160	2500	5.4	5.1	4.9
	20+20+35	4.60	5.17	1.60	1.60	2.80	-	1.4	6.0	7.5	270	1160	2500	5.4	5.1	4.9
	20+25+25	4.60	5.17	1.71	2.14	2.14	-	1.4	6.0	7.5	270	1160	2500	5.4	5.1	4.9
	20+25+35	4.60	5.17	1.50	1.88	2.63	-	1.4	6.0	7.5	270	1160	2500	5.4	5.1	4.9
	25+25+25	4.60	5.17	2.00	2.00	2.00	-	1.4	6.0	7.5	270	1160	2500	5.4	5.1	4.9
25+25+35	4.60	5.17	1.76	1.76	2.47	-	1.4	6.0	7.5	270	1160	2500	5.4	5.1	4.9	

SCOP = EU Regulation N. 206/2012 – Value measured in according to harmonized rule EN14825.

COP = Value measured in according to harmonized rule EN 14511.

PERFORMANCE TABLES MULTISPLIT R32

SCM 50 ZS-W

COOLING		Seasonal energy efficiency	EER	Cooling capacity (kW)							Power input (W)			Rated current (A)		
				Capacity for each room (kW)				Total capacity (kW)			Min.	Standard	Max.	220V	230V	240V
		Combined units		SEER	A	B	C	D	Min.	Standard						
1 unit	20		4.00	2.00	-	-	-	1.7	2.0	2.8	430	500	950	2.4	2.3	2.2
	25		3.68	2.50	-	-	-	1.7	2.5	3.4	430	680	1070	3.2	3.1	3.0
	35		3.47	3.50	-	-	-	1.7	3.5	3.9	430	1010	1230	4.7	4.5	4.3
	50		3.27	5.00	-	-	-	1.7	5.0	5.5	430	1530	2000	7.0	6.7	6.4
2 units	20+20		5.33	2.00	2.00	-	-	1.8	4.0	5.7	390	750	1750	3.5	3.3	3.2
	20+25		4.55	2.00	2.50	-	-	1.8	4.5	5.9	390	990	1910	4.6	4.4	4.2
	20+35	8.60	4.50	1.82	3.18	-	-	1.8	5.0	6.5	390	1110	2150	5.1	4.9	4.7
	20+50	8.60	4.50	1.43	3.57	-	-	1.8	5.0	6.5	390	1110	2150	5.1	4.9	4.7
	25+25	8.60	4.50	2.50	2.50	-	-	1.8	5.0	6.5	390	1110	2150	5.1	4.9	4.7
	25+35	8.60	4.50	2.08	2.92	-	-	1.8	5.0	6.5	390	1110	2150	5.1	4.9	4.7
	25+50	8.60	4.50	1.67	3.33	-	-	1.8	5.0	6.5	390	1110	2150	5.1	4.9	4.7
	35+35	8.60	4.50	2.50	2.50	-	-	1.8	5.0	6.5	390	1110	2150	5.1	4.9	4.7
3 units	20+20+20		8.80	1.67	1.67	1.67	-	2.1	5.0	7.1	350	1020	2150	4.7	4.5	4.3
	20+20+25		8.80	1.54	1.54	1.92	-	2.1	5.0	7.1	350	1020	2150	4.7	4.5	4.3
	20+20+35		8.80	1.33	1.33	2.33	-	2.1	5.0	7.1	350	1020	2150	4.7	4.5	4.3
	20+25+25		8.80	1.43	1.79	1.79	-	2.1	5.0	7.1	350	1020	2150	4.7	4.5	4.3
	20+25+35		8.80	1.25	1.56	2.19	-	2.1	5.0	7.1	350	1020	2150	4.7	4.5	4.3
	25+25+25		8.80	1.67	1.67	1.67	-	2.1	5.0	7.1	350	1020	2150	4.7	4.5	4.3
	25+25+35		8.80	1.47	1.47	2.06	-	2.1	5.0	7.1	350	1020	2150	4.7	4.5	4.3

SEER = EU Regulation N. 206/2012 – Value measured in according to harmonized rule EN14825.
EER = Value measured in according to harmonized rule EN 14511.

SCM 60 ZS-W

HEATING		Seasonal energy efficiency	COP	Heating capacity (kW)							Power input (W)			Rated current (A)			
				Capacity for each room (kW)				Total capacity (kW)			Min.	Standard	Max.	220V	230V	240V	
		Combined units		SCOP	A	B	C	D	Min.	Standard							Max.
1 unit	20		3.85	3.00	-	-	-	1.0	3.0	3.7	320	780	1100	3.6	3.5	3.3	
	25		3.58	3.40	-	-	-	1.0	3.4	4.2	320	950	1240	4.4	4.2	4.0	
	35		3.54	4.50	-	-	-	1.0	4.5	5.0	320	1270	1490	5.9	5.6	5.4	
	50		3.39	5.80	-	-	-	1.0	5.8	6.5	320	1710	2310	7.9	7.6	7.3	
	60		3.33	6.80	-	-	-	1.0	6.8	7.3	320	2040	2660	9.5	9.1	8.7	
2 units	20+20		5.14	2.70	2.70	-	-	1.2	5.4	7.3	290	1050	2100	4.9	4.7	4.5	
	20+25		5.00	2.62	3.28	-	-	1.2	5.9	7.5	290	1180	2550	5.5	5.2	5.0	
	20+35		4.85	2.40	4.20	-	-	1.2	6.6	7.6	290	1360	2800	6.3	6.0	5.8	
	20+50	4.70	4.72	1.94	4.86	-	-	1.2	6.8	7.6	290	1440	2800	6.7	6.4	6.1	
	20+60	4.70	4.72	1.70	5.10	-	-	1.2	6.8	7.6	290	1440	2800	6.7	6.4	6.1	
	25+25		4.89	3.20	3.20	-	-	1.2	6.4	7.6	290	1310	2800	6.1	5.8	5.6	
	25+35	4.70	4.72	2.83	3.97	-	-	1.2	6.8	7.6	290	1440	2800	6.7	6.4	6.1	
	25+50	4.70	4.72	2.27	4.53	-	-	1.2	6.8	7.6	290	1440	2800	6.7	6.4	6.1	
	25+60	4.70	4.72	2.00	4.80	-	-	1.2	6.8	7.6	290	1440	2800	6.7	6.4	6.1	
	35+35	4.70	4.72	3.40	3.40	-	-	1.2	6.8	7.6	290	1440	2800	6.7	6.4	6.1	
	35+50	4.70	4.72	2.80	4.00	-	-	1.2	6.8	7.6	290	1440	2800	6.7	6.4	6.1	
	35+60	4.70	4.72	2.51	4.29	-	-	1.2	6.8	7.6	290	1440	2800	6.7	6.4	6.1	
	50+50	4.70	4.72	3.40	3.40	-	-	1.2	6.8	7.6	290	1440	2800	6.7	6.4	6.1	
50+60	4.70	4.72	3.09	3.71	-	-	1.2	6.8	7.6	290	1440	2800	6.7	6.4	6.1		
3 units	20+20+20		4.60	4.86	2.27	2.27	2.27	-	1.4	6.8	7.8	270	1400	2800	6.5	6.2	6.0
	20+20+25		4.60	4.86	2.09	2.09	2.62	-	1.4	6.8	7.8	270	1400	2800	6.5	6.2	6.0
	20+20+35		4.60	4.86	1.81	1.81	3.17	-	1.4	6.8	7.8	270	1400	2800	6.5	6.2	6.0
	20+20+50		4.60	4.86	1.51	1.51	3.78	-	1.4	6.8	7.8	270	1400	2800	6.5	6.2	6.0
	20+20+60		4.60	4.86	1.36	1.36	4.08	-	1.4	6.8	7.8	270	1400	2800	6.5	6.2	6.0
	20+25+25		4.60	4.86	1.94	2.43	2.43	-	1.4	6.8	7.8	270	1400	2800	6.5	6.2	6.0
	20+25+35		4.60	4.86	1.70	2.13	2.98	-	1.4	6.8	7.8	270	1400	2800	6.5	6.2	6.0
	20+25+50		4.60	4.86	1.43	1.79	3.58	-	1.4	6.8	7.8	270	1400	2800	6.5	6.2	6.0
	20+25+60		4.60	4.86	1.30	1.62	3.89	-	1.4	6.8	7.8	270	1400	2800	6.5	6.2	6.0
	20+35+35		4.60	4.86	1.51	2.64	2.64	-	1.4	6.8	7.8	270	1400	2800	6.5	6.2	6.0
	20+35+50		4.60	4.86	1.30	2.27	3.24	-	1.4	6.8	7.8	270	1400	2800	6.5	6.2	6.0
	25+25+25		4.60	4.86	2.27	2.27	2.27	-	1.4	6.8	7.8	270	1400	2800	6.5	6.2	6.0
	25+25+35		4.60	4.86	2.00	2.00	2.80	-	1.4	6.8	7.8	270	1400	2800	6.5	6.2	6.0
	25+25+50		4.60	4.86	1.70	1.70	3.40	-	1.4	6.8	7.8	270	1400	2800	6.5	6.2	6.0
	25+25+60		4.60	4.86	1.55	1.55	3.71	-	1.4	6.8	7.8	270	1400	2800	6.5	6.2	6.0
	25+35+35		4.60	4.86	1.79	2.51	2.51	-	1.4	6.8	7.8	270	1400	2800	6.5	6.2	6.0
	25+35+50		4.60	4.86	1.55	2.16	3.09	-	1.4	6.8	7.8	270	1400	2800	6.5	6.2	6.0
35+35+35		4.60	4.86	2.27	2.27	2.27	-	1.4	6.8	7.8	270	1400	2800	6.5	6.2	6.0	

SCOP = EU Regulation N. 206/2012 – Value measured in according to harmonized rule EN14825.
COP = Value measured in according to harmonized rule EN 14511.

PERFORMANCE TABLES MULTISPLIT R32

R32

SCM 60 ZS-W

COOLING		Seasonal energy efficiency SEER	EER	Cooling capacity (kW)							Power input (W)			Rated current (A)		
				Capacity for each room (kW)				Total capacity (kW)			Min.	Standard	Max.	220V	230V	240V
				A	B	C	D	Min.	Standard	Max.						
1 unit	20	4.00	2.00	-	-	-	1.7	2.0	2.8	430	500	950	2.4	2.3	2.2	
	25	3.68	2.50	-	-	-	1.7	2.5	3.4	430	680	1080	3.2	3.1	3.0	
	35	3.47	3.50	-	-	-	1.7	3.5	3.9	430	1010	1240	4.7	4.5	4.3	
	50	3.27	5.00	-	-	-	1.7	5.0	6.1	430	1530	2100	7.0	6.7	6.4	
	60	3.19	6.00	-	-	-	1.7	6.0	6.3	430	1880	2280	8.6	8.3	7.9	
2 units	20+20	5.33	2.00	2.00	-	-	1.8	4.0	5.7	390	750	1750	3.5	3.3	3.2	
	20+25	4.55	2.00	2.50	-	-	1.8	4.5	5.9	390	990	1910	4.6	4.4	4.2	
	20+35	4.17	2.00	3.50	-	-	1.8	5.5	6.7	390	1320	2200	6.1	5.8	5.6	
	20+50	8.20	3.85	1.71	4.29	-	-	1.8	6.0	6.9	390	1560	2280	7.2	6.9	6.6
	20+60	8.20	3.85	1.50	4.50	-	-	1.8	6.0	6.9	390	1560	2280	7.2	6.9	6.6
	25+25	4.50	2.50	2.50	-	-	-	1.8	5.0	6.5	390	1110	2150	5.1	4.9	4.7
	25+35	8.20	3.85	2.50	3.50	-	-	1.8	6.0	6.9	390	1560	2280	7.2	6.9	6.6
	25+50	8.20	3.85	2.00	4.00	-	-	1.8	6.0	6.9	390	1560	2280	7.2	6.9	6.6
	25+60	8.20	3.85	1.76	4.24	-	-	1.8	6.0	6.9	390	1560	2280	7.2	6.9	6.6
	35+35	8.20	3.85	3.00	3.00	-	-	1.8	6.0	6.9	390	1560	2280	7.2	6.9	6.6
	35+50	8.20	3.85	2.47	3.53	-	-	1.8	6.0	6.9	390	1560	2280	7.2	6.9	6.6
	35+60	8.20	3.85	2.21	3.79	-	-	1.8	6.0	6.9	390	1560	2280	7.2	6.9	6.6
	50+50	8.20	3.85	3.00	3.00	-	-	1.8	6.0	6.9	390	1560	2280	7.2	6.9	6.6
	50+60	8.20	3.85	2.73	3.27	-	-	1.8	6.0	6.9	390	1560	2280	7.2	6.9	6.6
3 units	20+20+20	8.80	4.55	2.00	2.00	2.00	-	2.1	6.0	7.5	350	1320	2280	6.1	5.8	5.6
	20+20+25	8.80	4.55	1.85	1.85	2.31	-	2.1	6.0	7.5	350	1320	2280	6.1	5.8	5.6
	20+20+35	8.80	4.55	1.60	1.60	2.80	-	2.1	6.0	7.5	350	1320	2280	6.1	5.8	5.6
	20+20+50	8.80	4.55	1.33	1.33	3.33	-	2.1	6.0	7.5	350	1320	2280	6.1	5.8	5.6
	20+20+60	8.80	4.55	1.20	1.20	3.60	-	2.1	6.0	7.5	350	1320	2280	6.1	5.8	5.6
	20+25+25	8.80	4.55	1.71	2.14	2.14	-	2.1	6.0	7.5	350	1320	2280	6.1	5.8	5.6
	20+25+35	8.80	4.55	1.50	1.88	2.63	-	2.1	6.0	7.5	350	1320	2280	6.1	5.8	5.6
	20+25+50	8.80	4.55	1.26	1.58	3.16	-	2.1	6.0	7.5	350	1320	2280	6.1	5.8	5.6
	20+25+60	8.80	4.55	1.14	1.43	3.43	-	2.1	6.0	7.5	350	1320	2280	6.1	5.8	5.6
	20+35+35	8.80	4.55	1.33	2.33	2.33	-	2.1	6.0	7.5	350	1320	2280	6.1	5.8	5.6
	20+35+50	8.80	4.55	1.14	2.00	2.86	-	2.1	6.0	7.5	350	1320	2280	6.1	5.8	5.6
	25+25+25	8.80	4.55	2.00	2.00	2.00	-	2.1	6.0	7.5	350	1320	2280	6.1	5.8	5.6
	25+25+35	8.80	4.55	1.76	1.76	2.47	-	2.1	6.0	7.5	350	1320	2280	6.1	5.8	5.6
	25+25+50	8.80	4.55	1.50	1.50	3.00	-	2.1	6.0	7.5	350	1320	2280	6.1	5.8	5.6
	25+25+60	8.80	4.55	1.36	1.36	3.27	-	2.1	6.0	7.5	350	1320	2280	6.1	5.8	5.6
	25+35+35	8.80	4.55	1.58	2.21	2.21	-	2.1	6.0	7.5	350	1320	2280	6.1	5.8	5.6
	25+35+50	8.80	4.55	1.36	1.91	2.73	-	2.1	6.0	7.5	350	1320	2280	6.1	5.8	5.6
35+35+35	8.80	4.55	2.00	2.00	2.00	-	2.1	6.0	7.5	350	1320	2280	6.1	5.8	5.6	

SEER = EU Regulation N. 206/2012 – Value measured in according to harmonized rule EN14825.

EER = Value measured in according to harmonized rule EN 14511.

PERFORMANCE TABLES MULTISPLIT R32

R32

SCM 71 ZS-W

HEATING		Seasonal energy efficiency	COP	Heating capacity (kW)							Power input (W)			Rated current (A)			
				Capacity for each room (kW)				Total capacity (kW)			Min.	Standard	Max.	220V	230V	240V	
Combined units		SCOP	A	B	C	D	Min.	Standard	Max.	Min.							Standard
1 unit	20		3.57	3.00	-	-	-	1.1	3.0	3.7	390	840	1330	4.0	3.8	3.6	
	25		3.40	3.40	-	-	-	1.1	3.4	4.2	390	1000	1510	4.7	4.5	4.3	
	35		3.38	4.50	-	-	-	1.1	4.5	5.0	390	1330	1790	6.2	5.9	5.7	
	50		3.26	5.80	-	-	-	1.1	5.8	6.5	390	1780	2310	8.3	7.9	7.6	
	60		3.24	6.80	-	-	-	1.1	6.8	7.5	390	2100	2660	9.7	9.3	8.9	
2 units	20 + 20		4.22	2.70	2.70	-	-	1.5	5.4	7.4	350	1280	1870	6.0	5.7	5.5	
	20 + 25		4.18	2.62	3.28	-	-	1.5	5.9	7.7	350	1410	2130	6.6	6.3	6.0	
	20 + 35		4.11	2.51	4.39	-	-	1.5	6.9	8.3	350	1680	2650	7.8	7.5	7.1	
	20 + 50	4.20	4.10	2.46	6.14	-	-	1.5	8.6	8.9	350	2100	3000	9.7	9.3	8.9	
	20 + 60	4.20	4.10	2.15	6.45	-	-	1.5	8.6	8.9	350	2100	3000	9.7	9.3	8.9	
	25 + 25		4.16	3.20	3.20	-	-	1.5	6.4	8.1	350	1540	2480	7.1	6.8	6.5	
	25 + 35		4.09	3.08	4.32	-	-	1.5	7.4	8.6	350	1810	2910	8.4	8.0	7.7	
	25 + 50	4.20	4.10	2.87	5.73	-	-	1.5	8.6	8.9	350	2100	3000	9.7	9.3	8.9	
	25 + 60	4.20	4.10	2.53	6.07	-	-	1.5	8.6	8.9	350	2100	3000	9.7	9.3	8.9	
	35 + 35	4.20	4.10	4.30	4.30	-	-	1.5	8.6	8.9	350	2100	3000	9.7	9.3	8.9	
	35 + 50	4.20	4.10	3.54	5.06	-	-	1.5	8.6	8.9	350	2100	3000	9.7	9.3	8.9	
	35 + 60	4.20	4.10	3.17	5.43	-	-	1.5	8.6	8.9	350	2100	3000	9.7	9.3	8.9	
	50 + 50	4.20	4.10	4.30	4.30	-	-	1.5	8.6	8.9	350	2100	3000	9.7	9.3	8.9	
	50 + 60	4.20	4.10	3.91	4.69	-	-	1.5	8.6	8.9	350	2100	3000	9.7	9.3	8.9	
	60 + 60	4.20	4.10	4.30	4.30	-	-	1.5	8.6	8.9	350	2100	3000	9.7	9.3	8.9	
3 units	20 + 20 + 20		4.21	2.57	2.57	2.57	-	1.6	7.7	9.1	370	1830	3000	8.5	8.1	7.8	
	20 + 20 + 25		4.15	2.46	2.46	3.08	-	1.6	8.0	9.1	370	1930	3000	9.0	8.6	8.2	
	20 + 20 + 35	4.30	4.17	2.29	2.29	4.01	-	1.6	8.6	9.1	370	2060	3000	9.6	9.1	8.8	
	20 + 20 + 50	4.30	4.17	1.91	1.91	4.78	-	1.6	8.6	9.1	370	2060	3000	9.6	9.1	8.8	
	20 + 20 + 60	4.30	4.17	1.72	1.72	5.16	-	1.6	8.6	9.1	370	2060	3000	9.6	9.1	8.8	
	20 + 25 + 25	4.30	4.17	2.46	3.07	3.07	-	1.6	8.6	9.1	370	2060	3000	9.6	9.1	8.8	
	20 + 25 + 35	4.30	4.17	2.15	2.69	3.76	-	1.6	8.6	9.1	370	2060	3000	9.6	9.1	8.8	
	20 + 25 + 50	4.30	4.17	1.81	2.26	4.53	-	1.6	8.6	9.1	370	2060	3000	9.6	9.1	8.8	
	20 + 25 + 60	4.30	4.17	1.64	2.05	4.91	-	1.6	8.6	9.1	370	2060	3000	9.6	9.1	8.8	
	20 + 35 + 35	4.30	4.17	1.91	3.34	3.34	-	1.6	8.6	9.1	370	2060	3000	9.6	9.1	8.8	
	20 + 35 + 50	4.30	4.17	1.64	2.87	4.10	-	1.6	8.6	9.1	370	2060	3000	9.6	9.1	8.8	
	20 + 35 + 60	4.30	4.17	1.50	2.62	4.49	-	1.6	8.6	9.1	370	2060	3000	9.6	9.1	8.8	
	20 + 50 + 50	4.30	4.17	1.43	3.58	3.58	-	1.6	8.6	9.1	370	2060	3000	9.6	9.1	8.8	
	25 + 25 + 25	4.30	4.17	2.87	2.87	2.87	-	1.6	8.6	9.1	370	2060	3000	9.6	9.1	8.8	
	25 + 25 + 35	4.30	4.17	2.53	2.53	3.54	-	1.6	8.6	9.1	370	2060	3000	9.6	9.1	8.8	
	25 + 25 + 50	4.30	4.17	2.15	2.15	4.30	-	1.6	8.6	9.1	370	2060	3000	9.6	9.1	8.8	
	25 + 25 + 60	4.30	4.17	1.95	1.95	4.69	-	1.6	8.6	9.1	370	2060	3000	9.6	9.1	8.8	
	25 + 35 + 35	4.30	4.17	2.26	3.17	3.17	-	1.6	8.6	9.1	370	2060	3000	9.6	9.1	8.8	
	25 + 35 + 50	4.30	4.17	1.95	2.74	3.91	-	1.6	8.6	9.1	370	2060	3000	9.6	9.1	8.8	
	25 + 35 + 60	4.30	4.17	1.79	2.51	4.30	-	1.6	8.6	9.1	370	2060	3000	9.6	9.1	8.8	
	25 + 50 + 50	4.30	4.17	1.72	3.44	3.44	-	1.6	8.6	9.1	370	2060	3000	9.6	9.1	8.8	
35 + 35 + 35	4.30	4.17	2.87	2.87	2.87	-	1.6	8.6	9.1	370	2060	3000	9.6	9.1	8.8		
35 + 35 + 50	4.30	4.17	2.51	2.51	3.58	-	1.6	8.6	9.1	370	2060	3000	9.6	9.1	8.8		
4 units	20 + 20 + 20 + 20		4.60	4.91	2.15	2.15	2.15	1.7	8.6	9.4	350	1750	3000	8.1	7.8	7.4	
	20 + 20 + 20 + 25		4.60	4.91	2.02	2.02	2.53	1.7	8.6	9.4	350	1750	3000	8.1	7.8	7.4	
	20 + 20 + 20 + 35		4.60	4.91	1.81	1.81	3.17	1.7	8.6	9.4	350	1750	3000	8.1	7.8	7.4	
	20 + 20 + 20 + 50		4.60	4.91	1.56	1.56	3.91	1.7	8.6	9.4	350	1750	3000	8.1	7.8	7.4	
	20 + 20 + 20 + 60		4.60	4.91	1.43	1.43	4.30	1.7	8.6	9.4	350	1750	3000	8.1	7.8	7.4	
	20 + 20 + 25 + 25		4.60	4.91	1.91	1.91	2.39	2.39	1.7	8.6	9.4	350	1750	3000	8.1	7.8	7.4
	20 + 20 + 25 + 35		4.60	4.91	1.72	1.72	2.15	3.01	1.7	8.6	9.4	350	1750	3000	8.1	7.8	7.4
	20 + 20 + 25 + 50		4.60	4.91	1.50	1.50	1.87	3.74	1.7	8.6	9.4	350	1750	3000	8.1	7.8	7.4
	20 + 20 + 25 + 60		4.60	4.91	1.38	1.38	1.72	4.13	1.7	8.6	9.4	350	1750	3000	8.1	7.8	7.4
	20 + 20 + 35 + 35		4.60	4.91	1.56	1.56	2.74	2.74	1.7	8.6	9.4	350	1750	3000	8.1	7.8	7.4
	20 + 20 + 35 + 50		4.60	4.91	1.38	1.38	2.41	3.44	1.7	8.6	9.4	350	1750	3000	8.1	7.8	7.4
	20 + 25 + 25 + 25		4.60	4.91	1.81	2.26	2.26	2.26	1.7	8.6	9.4	350	1750	3000	8.1	7.8	7.4
	20 + 25 + 25 + 35		4.60	4.91	1.64	2.05	2.05	2.87	1.7	8.6	9.4	350	1750	3000	8.1	7.8	7.4
	20 + 25 + 25 + 50		4.60	4.91	1.43	1.79	1.79	3.58	1.7	8.6	9.4	350	1750	3000	8.1	7.8	7.4
	20 + 25 + 35 + 35		4.60	4.91	1.50	1.87	2.62	2.62	1.7	8.6	9.4	350	1750	3000	8.1	7.8	7.4
	20 + 35 + 35 + 35		4.60	4.91	1.38	2.41	2.41	2.41	1.7	8.6	9.4	350	1750	3000	8.1	7.8	7.4
	25 + 25 + 25 + 25		4.60	4.91	2.15	2.15	2.15	2.15	1.7	8.6	9.4	350	1750	3000	8.1	7.8	7.4
	25 + 25 + 25 + 35		4.60	4.91	1.95	1.95	1.95	2.74	1.7	8.6	9.4	350	1750	3000	8.1	7.8	7.4
	25 + 25 + 25 + 50		4.60	4.91	1.72	1.72	1.72	3.44	1.7	8.6	9.4	350	1750	3000	8.1	7.8	7.4
	25 + 25 + 35 + 35		4.60	4.91	1.79	1.79	2.51	2.51	1.7	8.6	9.4	350	1750	3000	8.1	7.8	7.4

SCOP = EU Regulation N. 206/2012 – Value measured in according to harmonized rule EN14825.

COP = Value measured in according to harmonized rule EN 14511.

PERFORMANCE TABLES MULTISPLIT R32

R32

SCM 71 ZS-W

COOLING		Seasonal energy efficiency	EER	Cooling capacity (kW)							Power input (W)			Rated current (A)		
				Capacity for each room (kW)				Total capacity (kW)			Min.	Standard	Max.	220V	230V	240V
				A	B	C	D	Min.	Standard	Max.						
1 unit	20	SEER	4.00	2.00	-	-	-	1.8	2.0	3.4	480	500	950	2.4	2.3	2.2
	25		3.68	2.50	-	-	-	1.8	2.5	3.8	480	680	1080	3.2	3.1	3.0
	35		3.47	3.50	-	-	-	1.8	3.5	4.5	480	1010	1240	4.7	4.5	4.3
	50		3.27	5.00	-	-	-	1.8	5.0	6.2	480	1530	2100	7.0	6.7	6.4
	60		3.19	6.00	-	-	-	1.8	6.0	6.9	480	1880	2700	8.6	8.3	7.9
2 units	20 + 20	7.20	4.76	2.00	2.00	-	-	3.0	4.0	6.1	550	840	1910	4.0	3.8	3.6
	20 + 25		4.55	2.00	2.50	-	-	3.0	4.5	6.4	550	990	2060	4.6	4.4	4.3
	20 + 35		4.17	2.00	3.50	-	-	3.0	5.5	6.9	550	1320	2320	6.1	5.8	5.6
	20 + 50		3.60	2.03	5.07	-	-	3.0	7.1	7.7	550	1970	2750	9.0	8.7	8.3
	20 + 60		3.60	1.78	5.33	-	-	3.0	7.1	7.7	550	1970	2750	9.0	8.7	8.3
	25 + 25		4.35	2.50	2.50	-	-	3.0	5.0	6.8	550	1150	2270	5.4	5.1	4.9
	25 + 35		4.01	2.46	3.44	-	-	3.0	5.9	7.2	550	1470	2470	6.8	6.5	6.2
	25 + 50		3.60	2.37	4.73	-	-	3.0	7.1	7.7	550	1970	2750	9.0	8.7	8.3
	25 + 60		3.60	2.09	5.01	-	-	3.0	7.1	7.7	550	1970	2750	9.0	8.7	8.3
	35 + 35		3.60	3.55	3.55	-	-	3.0	7.1	7.7	550	1970	2750	9.0	8.7	8.3
	35 + 50		3.60	2.92	4.18	-	-	3.0	7.1	7.7	550	1970	2750	9.0	8.7	8.3
	35 + 60		3.60	2.62	4.48	-	-	3.0	7.1	7.7	550	1970	2750	9.0	8.7	8.3
	50 + 50		3.60	3.55	3.55	-	-	3.0	7.1	7.7	550	1970	2750	9.0	8.7	8.3
	50 + 60		3.60	3.23	3.87	-	-	3.0	7.1	7.7	550	1970	2750	9.0	8.7	8.3
	60 + 60		3.60	3.55	3.55	-	-	3.0	7.1	7.7	550	1970	2750	9.0	8.7	8.3
3 units	20 + 20 + 20	7.80	4.84	2.00	2.00	2.00	-	3.7	6.0	8.2	670	1240	2750	5.8	5.5	5.3
	20 + 20 + 25	7.80	4.68	2.00	2.00	2.50	-	3.7	6.5	8.2	670	1390	2750	6.4	6.1	5.9
	20 + 20 + 35	7.80	4.67	1.89	1.89	3.31	-	3.7	7.1	8.2	670	1520	2750	7.0	6.7	6.4
	20 + 20 + 50	7.80	4.67	1.58	1.58	3.94	-	3.7	7.1	8.2	670	1520	2750	7.0	6.7	6.4
	20 + 20 + 60	7.80	4.67	1.42	1.42	4.26	-	3.7	7.1	8.2	670	1520	2750	7.0	6.7	6.4
	20 + 25 + 25	7.80	4.67	2.03	2.54	2.54	-	3.7	7.1	8.2	670	1520	2750	7.0	6.7	6.4
	20 + 25 + 35	7.80	4.67	1.78	2.22	3.11	-	3.7	7.1	8.2	670	1520	2750	7.0	6.7	6.4
	20 + 25 + 50	7.80	4.67	1.49	1.87	3.74	-	3.7	7.1	8.2	670	1520	2750	7.0	6.7	6.4
	20 + 25 + 60	7.80	4.67	1.35	1.69	4.06	-	3.7	7.1	8.2	670	1520	2750	7.0	6.7	6.4
	20 + 35 + 35	7.80	4.67	1.58	2.76	2.76	-	3.7	7.1	8.2	670	1520	2750	7.0	6.7	6.4
	20 + 35 + 50	7.80	4.67	1.35	2.37	3.38	-	3.7	7.1	8.2	670	1520	2750	7.0	6.7	6.4
	20 + 35 + 60	7.80	4.67	1.23	2.16	3.70	-	3.7	7.1	8.2	670	1520	2750	7.0	6.7	6.4
	20 + 50 + 50	7.80	4.67	1.18	2.96	2.96	-	3.7	7.1	8.2	670	1520	2750	7.0	6.7	6.4
	25 + 25 + 25	7.80	4.67	2.37	2.37	2.37	-	3.7	7.1	8.2	670	1520	2750	7.0	6.7	6.4
	25 + 25 + 35	7.80	4.67	2.09	2.09	2.92	-	3.7	7.1	8.2	670	1520	2750	7.0	6.7	6.4
	25 + 25 + 50	7.80	4.67	1.78	1.78	3.55	-	3.7	7.1	8.2	670	1520	2750	7.0	6.7	6.4
	25 + 25 + 60	7.80	4.67	1.61	1.61	3.87	-	3.7	7.1	8.2	670	1520	2750	7.0	6.7	6.4
	25 + 35 + 35	7.80	4.67	1.87	2.62	2.62	-	3.7	7.1	8.2	670	1520	2750	7.0	6.7	6.4
	25 + 35 + 50	7.80	4.67	1.61	2.26	3.23	-	3.7	7.1	8.2	670	1520	2750	7.0	6.7	6.4
	25 + 35 + 60	7.80	4.67	1.48	2.07	3.55	-	3.7	7.1	8.2	670	1520	2750	7.0	6.7	6.4
25 + 50 + 50	7.80	4.67	1.42	2.84	2.84	-	3.7	7.1	8.2	670	1520	2750	7.0	6.7	6.4	
35 + 35 + 35	7.80	4.67	2.37	2.37	2.37	-	3.7	7.1	8.2	670	1520	2750	7.0	6.7	6.4	
35 + 35 + 50	7.80	4.67	2.07	2.07	2.96	-	3.7	7.1	8.2	670	1520	2750	7.0	6.7	6.4	
4 units	20 + 20 + 20 + 20	8.30	5.00	1.78	1.78	1.78	1.78	4.4	7.1	8.8	890	1420	2750	6.5	6.2	6.0
	20 + 20 + 20 + 25		5.00	1.67	1.67	1.67	2.09	4.4	7.1	8.8	890	1420	2750	6.5	6.2	6.0
	20 + 20 + 20 + 35		5.00	1.49	1.49	1.49	2.62	4.4	7.1	8.8	890	1420	2750	6.5	6.2	6.0
	20 + 20 + 20 + 50		5.00	1.29	1.29	1.29	3.23	4.4	7.1	8.8	890	1420	2750	6.5	6.2	6.0
	20 + 20 + 20 + 60		5.00	1.18	1.18	1.18	3.55	4.4	7.1	8.8	890	1420	2750	6.5	6.2	6.0
	20 + 20 + 25 + 25		5.00	1.58	1.58	1.97	1.97	4.4	7.1	8.8	890	1420	2750	6.5	6.2	6.0
	20 + 20 + 25 + 35		5.00	1.42	1.42	1.78	2.49	4.4	7.1	8.8	890	1420	2750	6.5	6.2	6.0
	20 + 20 + 25 + 50		5.00	1.23	1.23	1.54	3.09	4.4	7.1	8.8	890	1420	2750	6.5	6.2	6.0
	20 + 20 + 25 + 60		5.00	1.14	1.14	1.42	3.41	4.4	7.1	8.8	890	1420	2750	6.5	6.2	6.0
	20 + 20 + 35 + 35		5.00	1.29	1.29	2.26	2.26	4.4	7.1	8.8	890	1420	2750	6.5	6.2	6.0
	20 + 20 + 35 + 50		5.00	1.14	1.14	1.99	2.84	4.4	7.1	8.8	890	1420	2750	6.5	6.2	6.0
	20 + 25 + 25 + 25		5.00	1.49	1.87	1.87	1.87	4.4	7.1	8.8	890	1420	2750	6.5	6.2	6.0
	20 + 25 + 25 + 35		5.00	1.35	1.69	1.69	2.37	4.4	7.1	8.8	890	1420	2750	6.5	6.2	6.0
	20 + 25 + 25 + 50		5.00	1.18	1.48	1.48	2.96	4.4	7.1	8.8	890	1420	2750	6.5	6.2	6.0
	20 + 25 + 35 + 35		5.00	1.23	1.54	2.16	2.16	4.4	7.1	8.8	890	1420	2750	6.5	6.2	6.0
	20 + 35 + 35 + 35		5.00	1.14	1.99	1.99	1.99	4.4	7.1	8.8	890	1420	2750	6.5	6.2	6.0
	25 + 25 + 25 + 25		5.00	1.78	1.78	1.78	1.78	4.4	7.1	8.8	890	1420	2750	6.5	6.2	6.0
	25 + 25 + 25 + 35		5.00	1.61	1.61	1.61	2.26	4.4	7.1	8.8	890	1420	2750	6.5	6.2	6.0
	25 + 25 + 25 + 50		5.00	1.42	1.42	1.42	2.84	4.4	7.1	8.8	890	1420	2750	6.5	6.2	6.0
	25 + 25 + 35 + 35		5.00	1.48	2.07	2.07	2.07	4.4	7.1	8.8	890	1420	2750	6.5	6.2	6.0

SEER = EU Regulation N. 206/2012 – Value measured in according to harmonized rule EN14825.

EER = Value measured in according to harmonized rule EN 14511.

PERFORMANCE TABLES MULTISPLIT R32

SCM 80 ZS-W

HEATING		Seasonal energy efficiency	COP	Heating capacity (kW)							Power input (W)			Rated current (A)		
				Capacity for each room (kW)				Total capacity (kW)			Min.	Standard	Max.	220V	230V	240V
Combined units		SCOP	A	B	C	D	Min.	Standard	Max.							
1 unit	20		3.57	3.00	-	-	-	1.1	3.0	3.7	390	840	1330	4.0	3.8	3.6
	25	3.40	3.40	-	-	-	1.1	3.4	4.2	390	1000	1510	4.7	4.5	4.3	
	35	3.38	4.50	-	-	-	1.1	4.5	5.0	390	1330	1790	6.2	5.9	5.7	
	50	3.26	5.80	-	-	-	1.1	5.8	6.5	390	1780	2310	8.3	7.9	7.6	
	60	3.24	6.80	-	-	-	1.1	6.8	7.5	390	2100	2660	9.7	9.3	8.9	
2 units	20 + 20	4.22	2.70	2.70	-	-	1.5	5.4	7.4	350	1280	1870	6.0	5.7	5.5	
	20 + 25	4.18	2.62	3.28	-	-	1.5	5.9	7.7	350	1410	2130	6.6	6.3	6.0	
	20 + 35	4.11	2.51	4.39	-	-	1.5	6.9	8.3	350	1680	2650	7.8	7.5	7.1	
	20 + 50	4.10	2.46	6.14	-	-	1.5	8.6	9.5	350	2100	3120	9.7	9.3	8.9	
	20 + 60	4.20	4.04	2.33	6.98	-	-	1.5	9.3	9.5	350	2300	3120	10.7	10.2	9.8
	25 + 25	4.16	3.20	3.20	-	-	1.5	6.4	8.1	350	1540	2480	7.1	6.8	6.5	
	25 + 35	4.09	3.08	4.32	-	-	1.5	7.4	8.6	350	1810	2910	8.4	8.0	7.7	
	25 + 50	4.10	2.87	5.57	-	-	1.5	8.6	9.5	350	2100	3120	9.7	9.3	8.9	
	25 + 60	4.20	4.04	2.74	6.56	-	-	1.5	9.3	9.5	350	2300	3120	10.7	10.2	9.8
	35 + 35	4.10	4.30	4.30	-	-	1.5	8.6	9.5	350	2100	3120	9.7	9.3	8.9	
	35 + 50	4.20	4.04	3.83	5.47	-	-	1.5	9.3	9.5	350	2300	3120	10.7	10.2	9.8
	35 + 60	4.20	4.04	3.43	5.87	-	-	1.5	9.3	9.5	350	2300	3120	10.7	10.2	9.8
	50 + 50	4.20	4.04	4.65	4.65	-	-	1.5	9.3	9.5	350	2300	3120	10.7	10.2	9.8
	50 + 60	4.20	4.04	4.23	5.07	-	-	1.5	9.3	9.5	350	2300	3120	10.7	10.2	9.8
	60 + 60	4.20	4.04	4.65	4.65	-	-	1.5	9.3	9.5	350	2300	3120	10.7	10.2	9.8
	3 units	20 + 20 + 20	4.21	2.57	2.57	2.57	-	1.6	7.7	9.6	370	1830	3120	8.5	8.1	7.8
20 + 20 + 25		4.15	2.46	2.46	3.08	-	1.6	8.0	9.6	370	1930	3120	9.0	8.6	8.2	
20 + 20 + 35		4.17	2.29	2.29	4.01	-	1.6	8.6	9.6	370	2060	3120	9.6	9.1	8.8	
20 + 20 + 50		4.30	4.13	2.07	2.07	5.17	-	1.6	9.3	9.6	370	2250	3120	10.4	10.0	9.6
20 + 20 + 60		4.30	4.13	1.86	1.86	5.58	-	1.6	9.3	9.6	370	2250	3120	10.4	10.0	9.6
20 + 25 + 25		4.17	2.46	3.07	3.07	-	1.6	8.6	9.6	370	2060	3120	9.6	9.1	8.8	
20 + 25 + 35		4.30	4.13	2.33	2.91	4.07	-	1.6	9.3	9.6	370	2250	3120	10.4	10.0	9.6
20 + 25 + 50		4.30	4.13	1.96	2.45	4.89	-	1.6	9.3	9.6	370	2250	3120	10.4	10.0	9.6
20 + 25 + 60		4.30	4.13	1.77	2.21	5.31	-	1.6	9.3	9.6	370	2250	3120	10.4	10.0	9.6
20 + 35 + 35		4.30	4.13	2.07	3.62	3.62	-	1.6	9.3	9.6	370	2250	3120	10.4	10.0	9.6
20 + 35 + 50		4.30	4.13	1.77	3.10	4.43	-	1.6	9.3	9.6	370	2250	3120	10.4	10.0	9.6
20 + 35 + 60		4.30	4.13	1.62	2.83	4.85	-	1.6	9.3	9.6	370	2250	3120	10.4	10.0	9.6
20 + 50 + 50		4.30	4.13	1.55	3.88	3.88	-	1.6	9.3	9.6	370	2250	3120	10.4	10.0	9.6
20 + 50 + 60		4.30	4.13	1.43	3.58	4.29	-	1.6	9.3	9.6	370	2250	3120	10.4	10.0	9.6
25 + 25 + 25		4.17	2.87	2.87	2.87	-	1.6	8.6	9.6	370	2060	3120	9.6	9.1	8.8	
25 + 25 + 35		4.30	4.13	2.74	2.74	3.83	-	1.6	9.3	9.6	370	2250	3120	10.4	10.0	9.6
25 + 25 + 50		4.30	4.13	2.33	2.33	4.65	-	1.6	9.3	9.6	370	2250	3120	10.4	10.0	9.6
25 + 25 + 60		4.30	4.13	2.11	2.11	5.07	-	1.6	9.3	9.6	370	2250	3120	10.4	10.0	9.6
25 + 35 + 35		4.30	4.13	2.45	3.43	3.43	-	1.6	9.3	9.6	370	2250	3120	10.4	10.0	9.6
25 + 35 + 50		4.30	4.13	2.11	2.96	4.23	-	1.6	9.3	9.6	370	2250	3120	10.4	10.0	9.6
25 + 35 + 60	4.30	4.13	1.94	2.71	5.65	-	1.6	9.3	9.6	370	2250	3120	10.4	10.0	9.6	
25 + 50 + 50	4.30	4.13	1.86	3.72	3.72	-	1.6	9.3	9.6	370	2250	3120	10.4	10.0	9.6	
25 + 50 + 60	4.30	4.13	1.72	3.44	4.13	-	1.6	9.3	9.6	370	2250	3120	10.4	10.0	9.6	
35 + 35 + 35	4.30	4.13	3.10	3.10	3.10	-	1.6	9.3	9.6	370	2250	3120	10.4	10.0	9.6	
35 + 35 + 50	4.30	4.13	2.71	2.71	3.88	-	1.6	9.3	9.6	370	2250	3120	10.4	10.0	9.6	
35 + 35 + 60	4.30	4.13	2.50	2.50	4.29	-	1.6	9.3	9.6	370	2250	3120	10.4	10.0	9.6	
35 + 50 + 50	4.30	4.13	2.41	3.44	3.44	-	1.6	9.3	9.6	370	2250	3120	10.4	10.0	9.6	
4 units	20 + 20 + 20 + 20	4.60	4.77	2.33	2.33	2.33	2.33	1.7	9.3	9.8	350	1950	3120	9.0	8.6	8.2
	20 + 20 + 20 + 25	4.60	4.77	2.19	2.19	2.19	2.74	1.7	9.3	9.8	350	1950	3120	9.0	8.6	8.2
	20 + 20 + 20 + 35	4.60	4.77	1.96	1.96	1.96	3.43	1.7	9.3	9.8	350	1950	3120	9.0	8.6	8.2
	20 + 20 + 20 + 50	4.60	4.77	1.69	1.69	1.69	4.23	1.7	9.3	9.8	350	1950	3120	9.0	8.6	8.2
	20 + 20 + 20 + 60	4.60	4.77	1.55	1.55	1.55	4.65	1.7	9.3	9.8	350	1950	3120	9.0	8.6	8.2
	20 + 20 + 25 + 25	4.60	4.77	2.07	2.07	2.58	2.58	1.7	9.3	9.8	350	1950	3120	9.0	8.6	8.2
	20 + 20 + 25 + 35	4.60	4.77	1.86	1.86	2.33	3.26	1.7	9.3	9.8	350	1950	3120	9.0	8.6	8.2
	20 + 20 + 25 + 50	4.60	4.77	1.62	1.62	2.02	4.04	1.7	9.3	9.8	350	1950	3120	9.0	8.6	8.2
	20 + 20 + 25 + 60	4.60	4.77	1.49	1.49	1.86	4.46	1.7	9.3	9.8	350	1950	3120	9.0	8.6	8.2
	20 + 20 + 35 + 35	4.60	4.77	1.69	1.69	2.96	2.96	1.7	9.3	9.8	350	1950	3120	9.0	8.6	8.2
	20 + 20 + 35 + 50	4.60	4.77	1.49	1.49	2.60	3.72	1.7	9.3	9.8	350	1950	3120	9.0	8.6	8.2
	20 + 20 + 35 + 60	4.60	4.77	1.38	1.38	2.41	4.13	1.7	9.3	9.8	350	1950	3120	9.0	8.6	8.2
	20 + 25 + 25 + 25	4.60	4.77	1.96	2.45	2.45	2.45	1.7	9.3	9.8	350	1950	3120	9.0	8.6	8.2
	20 + 25 + 25 + 35	4.60	4.77	1.77	2.21	2.21	3.10	1.7	9.3	9.8	350	1950	3120	9.0	8.6	8.2
	20 + 25 + 25 + 50	4.60	4.77	1.55	1.94	1.94	3.88	1.7	9.3	9.8	350	1950	3120	9.0	8.6	8.2
	20 + 25 + 25 + 60	4.60	4.77	1.43	1.79	1.79	4.29	1.7	9.3	9.8	350	1950	3120	9.0	8.6	8.2
	20 + 25 + 35 + 35	4.60	4.77	1.62	2.02	2.83	2.83	1.7	9.3	9.8	350	1950	3120	9.0	8.6	8.2
	20 + 25 + 35 + 50	4.60	4.77	1.43	1.79	2.50	3.58	1.7	9.3	9.8	350	1950	3120	9.0	8.6	8.2
	20 + 35 + 35 + 35	4.60	4.77	1.49	2.60	2.60	2.60	1.7	9.3	9.8	350	1950	3120	9.0	8.6	8.2
	25 + 25 + 25 + 25	4.60	4.77	2.33	2.33	2.33	2.33	1.7	9.3	9.8	350	1950	3120	9.0	8.6	8.2
	25 + 25 + 25 + 35	4.60	4.77	2.11	2.11	2.11	2.96	1.7	9.3	9.8	350	1950	3120	9.0	8.6	8.2
	25 + 25 + 25 + 50	4.60	4.77	1.86	1.86	1.86	3.72	1.7	9.3	9.8	350	1950	3120	9.0	8.6	8.2
	25 + 25 + 25 + 60	4.60	4.77	1.72	1.72	1.72	4.13	1.7	9.3	9.8	350	1950	3120	9.0	8.6	8.2
	25 + 25 + 35 + 35	4.60	4.77	1.94	1.94	2.71	2.71	1.7	9.3	9.8	350	1950	3120	9.0	8.6	8.2
25 + 25 + 35 + 50	4.60	4.77	1.72	1.72	2.41	3.44	1.7	9.3	9.8	350	1950	3120	9.0	8.6	8.2	
25 + 35 + 35 + 35	4.60	4.77	1.79	2.50	2.50	2.50	1.7	9.3	9.8	350	1950	3120	9.0	8.6	8.2	

SCOP = EU Regulation N. 206/2012 – Value measured in according to harmonized rule EN14825.
COP = Value measured in according to harmonized rule EN 14511.

PERFORMANCE TABLES MULTISPLIT R32

R32

SCM 80 ZS-W

COOLING		Seasonal energy efficiency	EER	Cooling capacity (kW)							Power input (W)			Rated current (A)		
				Capacity for each room (kW)				Total capacity (kW)			Min.	Standard	Max.	220V	230V	240V
Combined units	SEER	A	B	C	D	Min.	Standard	Max.								
		1 unit	20	4.00	2.00	-	-	-	1.8	2.0	2.8	480	500	950	2.4	2.3
25	3.68		2.50	-	-	-	1.8	2.5	3.4	480	680	1080	3.2	3.1	3.0	
35	3.47		3.50	-	-	-	1.8	3.5	3.9	480	1010	1240	4.7	4.5	4.3	
50	3.27		5.00	-	-	-	1.8	5.0	6.1	480	1530	2100	7.0	6.7	6.4	
60	3.19		6.00	-	-	-	1.8	6.0	7.0	480	1880	2700	8.6	8.3	7.9	
2 units	20 + 20	4.76	2.00	2.00	-	-	3.0	4.0	6.1	550	840	1910	4.0	3.8	3.6	
	20 + 25	4.55	2.00	2.50	-	-	3.0	4.5	6.4	550	990	2060	4.6	4.4	4.3	
	20 + 35	4.17	2.00	3.50	-	-	3.0	5.5	6.9	550	1320	2320	6.1	5.8	5.6	
	20 + 50	3.60	2.03	5.07	-	-	3.0	7.1	8.5	550	1970	2830	9.0	8.7	8.3	
	20 + 60	7.10	3.31	2.00	6.00	-	-	3.0	8.0	8.5	550	2420	2830	11.1	10.6	10.2
	25 + 25	4.35	2.50	2.50	-	-	3.0	5.0	6.8	550	1150	2270	5.4	5.1	4.9	
	25 + 35	3.78	2.46	3.44	-	-	3.0	5.9	7.2	550	1560	2470	7.2	6.9	6.6	
	25 + 50	3.54	2.47	4.93	-	-	3.0	7.4	8.5	550	2090	2830	9.6	9.2	8.8	
	25 + 60	7.10	3.31	2.35	5.65	-	-	3.0	8.0	8.5	550	2420	2830	11.1	10.6	10.2
	35 + 35	3.60	3.55	3.55	-	-	3.0	7.1	8.5	550	1970	2830	9.0	8.7	8.3	
	35 + 50	7.10	3.31	3.29	4.71	-	-	3.0	8.0	8.5	550	2420	2830	11.1	10.6	10.2
	35 + 60	7.10	3.31	2.95	5.05	-	-	3.0	8.0	8.5	550	2420	2830	11.1	10.6	10.2
	50 + 50	7.10	3.31	4.00	4.00	-	-	3.0	8.0	8.5	550	2420	2830	11.1	10.6	10.2
	50 + 60	7.10	3.31	3.64	4.36	-	-	3.0	8.0	8.5	550	2420	2830	11.1	10.6	10.2
	60 + 60	7.10	3.31	4.00	4.00	-	-	3.0	8.0	8.5	550	2420	2830	11.1	10.6	10.2
	3 units	20 + 20 + 20	4.84	2.00	2.00	2.00	-	3.7	6.0	8.8	670	1240	2830	5.8	5.5	5.3
20 + 20 + 25		4.68	2.00	2.00	2.50	-	3.7	6.5	8.8	670	1390	2830	6.4	6.1	5.9	
20 + 20 + 35		4.67	1.89	1.89	3.31	-	3.7	7.1	8.8	670	1520	2830	7.0	6.7	6.4	
20 + 20 + 50		7.70	4.19	1.78	1.78	4.44	-	3.7	8.0	8.8	670	1910	2830	8.8	8.4	8.0
20 + 20 + 60		7.70	4.19	1.60	1.60	4.80	-	3.7	8.0	8.8	670	1910	2830	8.8	8.4	8.0
20 + 25 + 25		4.67	2.03	2.54	2.54	-	3.7	7.1	8.8	670	1520	2830	7.0	6.7	6.4	
20 + 25 + 35		7.70	4.19	2.00	2.50	3.50	-	3.7	8.0	8.8	670	1910	2830	8.8	8.4	8.0
20 + 25 + 50		7.70	4.19	1.68	2.11	4.21	-	3.7	8.0	8.8	670	1910	2830	8.8	8.4	8.0
20 + 25 + 60		7.70	4.19	1.52	1.90	4.57	-	3.7	8.0	8.8	670	1910	2830	8.8	8.4	8.0
20 + 35 + 35		7.70	4.19	1.78	3.11	3.11	-	3.7	8.0	8.8	670	1910	2830	8.8	8.4	8.0
20 + 35 + 50		7.70	4.19	1.52	2.67	3.81	-	3.7	8.0	8.8	670	1910	2830	8.8	8.4	8.0
20 + 35 + 60		7.70	4.19	1.39	2.43	4.17	-	3.7	8.0	8.8	670	1910	2830	8.8	8.4	8.0
20 + 50 + 50		7.70	4.19	1.33	3.33	3.33	-	3.7	8.0	8.8	670	1910	2830	8.8	8.4	8.0
20 + 50 + 60		7.70	4.19	1.23	3.08	3.69	-	3.7	8.0	8.8	670	1910	2830	8.8	8.4	8.0
25 + 25 + 25		4.67	2.37	2.37	2.37	-	3.7	7.1	8.8	670	1520	2830	7.0	6.7	6.4	
25 + 25 + 35		7.70	4.19	2.35	2.35	3.29	-	3.7	8.0	8.8	670	1910	2830	8.8	8.4	8.0
25 + 25 + 50		7.70	4.19	2.00	2.00	4.00	-	3.7	8.0	8.8	670	1910	2830	8.8	8.4	8.0
25 + 25 + 60		7.70	4.19	1.82	1.82	4.36	-	3.7	8.0	8.8	670	1910	2830	8.8	8.4	8.0
25 + 35 + 35		7.70	4.19	2.11	2.95	2.95	-	3.7	8.0	8.8	670	1910	2830	8.8	8.4	8.0
25 + 35 + 50		7.70	4.19	1.82	2.55	3.64	-	3.7	8.0	8.8	670	1910	2830	8.8	8.4	8.0
25 + 35 + 60		7.70	4.19	1.67	2.33	4.00	-	3.7	8.0	8.8	670	1910	2830	8.8	8.4	8.0
25 + 50 + 50		7.70	4.19	1.60	3.20	3.20	-	3.7	8.0	8.8	670	1910	2830	8.8	8.4	8.0
25 + 50 + 60	7.70	4.19	1.48	2.96	3.56	-	3.7	8.0	8.8	670	1910	2830	8.8	8.4	8.0	
35 + 35 + 35	7.70	4.19	2.67	2.67	2.67	-	3.7	8.0	8.8	670	1910	2830	8.8	8.4	8.0	
35 + 35 + 50	7.70	4.19	2.33	2.33	3.33	-	3.7	8.0	8.8	670	1910	2830	8.8	8.4	8.0	
35 + 35 + 60	7.70	4.19	2.15	2.15	3.69	-	3.7	8.0	8.8	670	1910	2830	8.8	8.4	8.0	
35 + 50 + 50	7.70	4.19	2.07	2.96	2.96	-	3.7	8.0	8.8	670	1910	2830	8.8	8.4	8.0	
4 units	20 + 20 + 20 + 20	8.20	4.71	2.00	2.00	2.00	2.00	4.4	8.0	9.2	890	1700	2830	7.8	7.5	7.2
	20 + 20 + 20 + 25	8.20	4.71	1.88	1.88	1.88	2.35	4.4	8.0	9.2	890	1700	2830	7.8	7.5	7.2
	20 + 20 + 20 + 35	8.20	4.71	1.68	1.68	1.68	2.95	4.4	8.0	9.2	890	1700	2830	7.8	7.5	7.2
	20 + 20 + 20 + 50	8.20	4.71	1.45	1.45	1.45	3.64	4.4	8.0	9.2	890	1700	2830	7.8	7.5	7.2
	20 + 20 + 20 + 60	8.20	4.71	1.33	1.33	1.33	4.00	4.4	8.0	9.2	890	1700	2830	7.8	7.5	7.2
	20 + 20 + 25 + 25	8.20	4.71	1.78	1.78	2.22	2.22	4.4	8.0	9.2	890	1700	2830	7.8	7.5	7.2
	20 + 20 + 25 + 35	8.20	4.71	1.60	1.60	2.00	2.80	4.4	8.0	9.2	890	1700	2830	7.8	7.5	7.2
	20 + 20 + 25 + 50	8.20	4.71	1.39	1.39	1.74	3.48	4.4	8.0	9.2	890	1700	2830	7.8	7.5	7.2
	20 + 20 + 25 + 60	8.20	4.71	1.28	1.28	1.60	3.84	4.4	8.0	9.2	890	1700	2830	7.8	7.5	7.2
	20 + 20 + 35 + 35	8.20	4.71	1.45	1.45	2.55	2.55	4.4	8.0	9.2	890	1700	2830	7.8	7.5	7.2
	20 + 20 + 35 + 50	8.20	4.71	1.28	1.28	2.24	3.20	4.4	8.0	9.2	890	1700	2830	7.8	7.5	7.2
	20 + 20 + 35 + 60	8.20	4.71	1.19	1.19	2.07	3.56	4.4	8.0	9.2	890	1700	2830	7.8	7.5	7.2
	20 + 25 + 25 + 25	8.20	4.71	1.68	2.11	2.11	2.11	4.4	8.0	9.2	890	1700	2830	7.8	7.5	7.2
	20 + 25 + 25 + 35	8.20	4.71	1.52	1.90	1.90	2.67	4.4	8.0	9.2	890	1700	2830	7.8	7.5	7.2
	20 + 25 + 25 + 50	8.20	4.71	1.33	1.67	1.67	3.33	4.4	8.0	9.2	890	1700	2830	7.8	7.5	7.2
	20 + 25 + 25 + 60	8.20	4.71	1.23	1.54	1.54	3.69	4.4	8.0	9.2	890	1700	2830	7.8	7.5	7.2
	20 + 25 + 35 + 35	8.20	4.71	1.39	1.74	2.43	2.43	4.4	8.0	9.2	890	1700	2830	7.8	7.5	7.2
	20 + 25 + 35 + 50	8.20	4.71	1.23	1.54	2.15	3.08	4.4	8.0	9.2	890	1700	2830	7.8	7.5	7.2
	20 + 25 + 35 + 60	8.20	4.71	1.18	1.24	2.24	2.24	4.4	8.0	9.2	890	1700	2830	7.8	7.5	7.2
	25 + 25 + 25 + 25	8.20	4.71	2.00	2.00	2.00	2.00	4.4	8.0	9.2	890	1700	2830	7.8	7.5	7.2
	25 + 25 + 25 + 35	8.20	4.71	1.82	1.82	1.82	2.55	4.4	8.0	9.2	890	1700	2830	7.8	7.5	7.2
	25 + 25 + 25 + 50	8.20	4.71	1.60	1.60	1.60	3.20	4.4	8.0	9.2	890	1700	2830	7.8	7.5	7.2
	25 + 25 + 25 + 60	8.20	4.71	1.48	1.48	1.48	3.56	4.4	8.0	9.2	890	1700	2830	7.8	7.5	7.2
	25 + 25 + 35 + 35	8.20	4.71	1.67	1.67	2.33	2.33	4.4	8.0	9.2	890	1700	2830	7.8	7.5	7.2
	25 + 25 + 35 + 50	8.20	4.71	1.48	1.48	2.07	2.96	4.4	8.0	9.2	890	1700	2830	7.8	7.5	7.2
	25 + 35 + 35 + 35	8.20	4.71	1.54	2.15	2.15	2.15	4.4	8.0	9.2	890	1700	2830	7.8	7.5	7.2

SEER = EU Regulation N. 206/2012 – Value measured in according to harmonized rule EN14825.
 EER = Value measured in according to harmonized rule EN 14511.

PERFORMANCE TABLES MULTISPLIT R32

SCM 100 ZS-W

HEATING		Seasonal energy efficiency	COP	Heating capacity (kW)									Power input (W)			Rated current (A)		
				Capacity for each room (kW)					Total capacity (kW)				Min.	Standard	Max.	220V	230V	240V
Combined units	SCOP	A	B	C	D	E	Min.	Standard	Max.	Min.	Standard	Max.						
													1 unit	20		2.83	3.00	-
25		2.98	3.40	-	-	-	-	0.9	3.4	4.0	490	1140		1400	5.4	5.2	5.0	
35		3.33	4.50	-	-	-	-	0.9	4.5	4.8	490	1350		1570	6.3	6.1	5.8	
50		3.60	5.80	-	-	-	-	0.9	5.8	6.2	490	1610		1770	7.4	7.1	6.8	
60		3.78	6.80	-	-	-	-	0.9	6.8	7.1	490	1800		1920	8.3	7.9	7.6	
71		3.94	8.00	-	-	-	-	0.9	8.0	8.1	490	2030		2110	9.3	8.9	8.5	
	80		4.05	9.00	-	-	-	-	0.9	9.0	9.1	490	2220	2260	10.2	9.7	9.3	
2 units	20+20		4.62	2.70	2.70	-	-	-	1.2	5.4	7.0	460	1170	1610	5.5	5.2	5.0	
	20+25		4.50	2.62	3.28	-	-	-	1.2	5.9	7.3	460	1310	1690	6.0	5.8	5.5	
	20+35		4.37	2.51	4.39	-	-	-	1.2	6.9	7.9	460	1580	1860	7.3	6.9	6.6	
	20+50		4.13	2.51	6.29	-	-	-	1.2	8.8	9.2	460	2130	2240	9.8	9.4	9.0	
	20+60		4.03	2.45	7.35	-	-	-	1.2	9.8	10.3	460	2430	2580	11.2	10.7	10.2	
	20+71	4.10	4.00	2.31	8.19	-	-	-	1.2	10.5	11.2	460	2620	2900	12.0	11.5	11.0	
	20+80	4.10	4.00	2.10	8.40	-	-	-	1.2	10.5	11.2	460	2620	2900	12.0	11.5	11.0	
	25+25		4.44	3.20	3.20	-	-	-	1.2	6.4	7.7	460	1440	1810	6.6	6.3	6.1	
	25+35		4.26	3.25	4.55	-	-	-	1.2	7.8	8.2	460	1830	1950	8.4	8.0	7.7	
	25+50		4.11	3.07	6.13	-	-	-	1.2	9.2	9.6	460	2240	2370	10.3	9.8	9.4	
	25+60		4.00	3.00	7.20	-	-	-	1.2	10.2	10.7	460	2550	2710	11.7	11.2	10.7	
	25+71	4.10	4.00	2.73	7.77	-	-	-	1.2	10.5	11.2	460	2620	2900	12.0	11.5	11.0	
	25+80	4.10	4.00	2.50	8.00	-	-	-	1.2	10.5	11.2	460	2620	2900	12.0	11.5	11.0	
	35+35		4.13	4.50	4.50	-	-	-	1.2	9.0	9.4	460	2180	2310	10.0	9.6	9.2	
	35+50		4.02	4.24	6.06	-	-	-	1.2	10.3	10.8	460	2560	2740	11.8	11.2	10.8	
	35+60	4.10	4.00	3.87	6.63	-	-	-	1.2	10.5	11.2	460	2620	2900	12.0	11.5	11.0	
	35+71	4.10	4.00	3.47	7.03	-	-	-	1.2	10.5	11.2	460	2620	2900	12.0	11.5	11.0	
	35+80	4.10	4.00	3.20	7.30	-	-	-	1.2	10.5	11.2	460	2620	2900	12.0	11.5	11.0	
	50+50	4.10	4.00	5.25	5.25	-	-	-	1.2	10.5	11.2	460	2620	2900	12.0	11.5	11.0	
	50+60	4.10	4.00	4.77	5.73	-	-	-	1.2	10.5	11.2	460	2620	2900	12.0	11.5	11.0	
	50+71	4.10	4.00	4.34	6.16	-	-	-	1.2	10.5	11.2	460	2620	2900	12.0	11.5	11.0	
	50+80	4.10	4.00	4.04	6.46	-	-	-	1.2	10.5	11.2	460	2620	2900	12.0	11.5	11.0	
60+60	4.10	4.00	5.25	5.25	-	-	-	1.2	10.5	11.2	460	2620	2900	12.0	11.5	11.0		
60+71	4.10	4.00	4.81	5.69	-	-	-	1.2	10.5	11.2	460	2620	2900	12.0	11.5	11.0		
60+80	4.10	4.00	4.50	6.00	-	-	-	1.2	10.5	11.2	460	2620	2900	12.0	11.5	11.0		
71+71	4.10	4.00	5.25	5.25	-	-	-	1.2	10.5	11.2	460	2620	2900	12.0	11.5	11.0		
71+80	4.10	4.00	4.94	5.56	-	-	-	1.2	10.5	11.2	460	2620	2900	12.0	11.5	11.0		
80+80	4.10	4.00	5.25	5.25	-	-	-	1.2	10.5	11.2	460	2620	2900	12.0	11.5	11.0		
3 units	20+20+20		4.21	3.00	3.00	3.00	-	-	1.4	9.0	9.6	430	2140	2320	9.8	9.4	9.0	
	20+20+25		4.16	2.89	2.89	3.62	-	-	1.4	9.4	10.0	430	2260	2440	10.4	9.9	9.5	
	20+20+35		4.13	2.80	2.80	4.90	-	-	1.4	10.5	11.3	430	2540	2900	11.7	11.2	10.7	
	20+20+50	4.20	4.13	2.33	2.33	5.83	-	-	1.4	10.5	11.3	430	2540	2900	11.7	11.2	10.7	
	20+20+60	4.20	4.13	2.10	2.10	6.30	-	-	1.4	10.5	11.3	430	2540	2900	11.7	11.2	10.7	
	20+20+71	4.20	4.13	1.89	1.89	6.72	-	-	1.4	10.5	11.3	430	2540	2900	11.7	11.2	10.7	
	20+20+80	4.20	4.13	1.75	1.75	7.00	-	-	1.4	10.5	11.3	430	2540	2900	11.7	11.2	10.7	
	20+25+25		4.13	3.00	3.75	3.75	-	-	1.4	10.5	11.3	430	2540	2900	11.7	11.2	10.7	
	20+25+35		4.13	2.63	3.28	4.59	-	-	1.4	10.5	11.3	430	2540	2900	11.7	11.2	10.7	
	20+25+50	4.20	4.13	2.21	2.76	5.53	-	-	1.4	10.5	11.3	430	2540	2900	11.7	11.2	10.7	
	20+25+60	4.20	4.13	2.00	2.50	6.00	-	-	1.4	10.5	11.3	430	2540	2900	11.7	11.2	10.7	
	20+35+35	4.20	4.13	2.33	4.08	4.08	-	-	1.4	10.5	11.3	430	2540	2900	11.7	11.2	10.7	
	20+35+50	4.20	4.13	2.00	3.50	5.00	-	-	1.4	10.5	11.3	430	2540	2900	11.7	11.2	10.7	
	20+35+60	4.20	4.13	1.83	3.20	5.48	-	-	1.4	10.5	11.3	430	2540	2900	11.7	11.2	10.7	
	20+35+71	4.20	4.13	1.67	2.92	5.92	-	-	1.4	10.5	11.3	430	2540	2900	11.7	11.2	10.7	
	20+35+80	4.20	4.13	1.56	2.72	6.22	-	-	1.4	10.5	11.3	430	2540	2900	11.7	11.2	10.7	
	20+50+50	4.20	4.13	1.75	4.38	4.38	-	-	1.4	10.5	11.3	430	2540	2900	11.7	11.2	10.7	
	20+50+60	4.20	4.13	1.62	4.04	4.85	-	-	1.4	10.5	11.3	430	2540	2900	11.7	11.2	10.7	
	20+50+71	4.20	4.13	1.49	3.72	5.29	-	-	1.4	10.5	11.3	430	2540	2900	11.7	11.2	10.7	
	20+50+80	4.20	4.13	1.40	3.50	5.60	-	-	1.4	10.5	11.3	430	2540	2900	11.7	11.2	10.7	
	20+60+60	4.20	4.13	1.50	4.50	4.50	-	-	1.4	10.5	11.3	430	2540	2900	11.7	11.2	10.7	
	20+60+71	4.20	4.13	1.39	4.17	4.94	-	-	1.4	10.5	11.3	430	2540	2900	11.7	11.2	10.7	
	20+60+80	4.20	4.13	1.31	3.94	5.25	-	-	1.4	10.5	11.3	430	2540	2900	11.7	11.2	10.7	
	25+25+25		4.13	3.50	3.50	3.50	-	-	1.4	10.5	11.3	430	2540	2900	11.7	11.2	10.7	
	25+25+35		4.13	3.09	3.09	4.32	-	-	1.4	10.5	11.3	430	2540	2900	11.7	11.2	10.7	
	25+25+50	4.20	4.13	2.63	2.63	5.25	-	-	1.4	10.5	11.3	430	2540	2900	11.7	11.2	10.7	
	25+25+60	4.20	4.13	2.39	2.39	5.73	-	-	1.4	10.5	11.3	430	2540	2900	11.7	11.2	10.7	
	25+25+71	4.20	4.13	2.17	2.17	6.16	-	-	1.4	10.5	11.3	430	2540	2900	11.7	11.2	10.7	
	25+25+80	4.20	4.13	2.02	2.02	6.46	-	-	1.4	10.5	11.3	430	2540	2900	11.7	11.2	10.7	
	25+35+35	4.20	4.13	2.76	3.87	3.87	-	-	1.4	10.5	11.3	430	2540	2900	11.7	11.2	10.7	
	25+35+50	4.20	4.13	2.39	3.34	4.77	-	-	1.4	10.5	11.3	430	2540	2900	11.7	11.2	10.7	
	25+35+60	4.20	4.13	2.19	3.06	5.25	-	-	1.4	10.5	11.3	430	2540	2900	11.7	11.2	10.7	
25+35+71	4.20	4.13	2.00	2.81	5.69	-	-	1.4	10.5	11.3	430	2540	2900	11.7	11.2	10.7		
25+35+80	4.20	4.13	1.88	2.63	6.00	-	-	1.4	10.5	11.3	430	2540	2900	11.7	11.2	10.7		
25+50+50	4.20	4.13	2.10	4.20	4.20	-	-	1.4	10.5	11.3	430	2540	2900	11.7	11.2	10.7		
25+50+60	4.20	4.13	1.94	3.89	4.67	-	-	1.4	10.5	11.3	430	2540	2900	11.7	11.2	10.7		
25+50+71	4.20	4.13	1.80	3.60	5.11	-	-	1.4	10.5	11.3	430	2540	2900	11.7	11.2	10.7		
25+50+80	4.20	4.13	1.69	3.39	5.42	-	-	1.4	10.5	11.3	430	2540	2900	11.7	11.2	10.7		

SCOP = EU Regulation N. 206/2012 - Value measured in according to harmonized rule EN14825.
 COP = Value measured in according to harmonized rule EN 14511.

PERFORMANCE TABLES MULTISPLIT R32

R32

SCM 100 ZS-W

HEATING		Seasonal energy efficiency	COP	Heating capacity (kW)									Power input (W)			Rated current (A)		
				Capacity for each room (kW)					Total capacity (kW)				Min.	Standard	Max.	220V	230V	240V
				A	B	C	D	E	Min.	Standard	Max.							
3 units	25+60+60	4.20	4.13	1.81	4.34	4.34	-	-	1.4	10.5	11.3	430	2540	2900	11.7	11.2	10.7	
	25+60+71	4.20	4.13	1.68	4.04	4.78	-	-	1.4	10.5	11.3	430	2540	2900	11.7	11.2	10.7	
	35+35+35	4.20	4.13	3.50	3.50	3.50	-	-	1.4	10.5	11.3	430	2540	2900	11.7	11.2	10.7	
	35+35+50	4.20	4.13	3.06	3.06	4.38	-	-	1.4	10.5	11.3	430	2540	2900	11.7	11.2	10.7	
	35+35+60	4.20	4.13	2.83	2.83	4.85	-	-	1.4	10.5	11.3	430	2540	2900	11.7	11.2	10.7	
	35+35+71	4.20	4.13	2.61	2.61	5.29	-	-	1.4	10.5	11.3	430	2540	2900	11.7	11.2	10.7	
	35+35+80	4.20	4.13	2.45	2.45	5.60	-	-	1.4	10.5	11.3	430	2540	2900	11.7	11.2	10.7	
	35+50+50	4.20	4.13	2.72	3.89	3.89	-	-	1.4	10.5	11.3	430	2540	2900	11.7	11.2	10.7	
	35+50+60	4.20	4.13	2.53	3.62	4.34	-	-	1.4	10.5	11.3	430	2540	2900	11.7	11.2	10.7	
	35+50+71	4.20	4.13	2.36	3.37	4.78	-	-	1.4	10.5	11.3	430	2540	2900	11.7	11.2	10.7	
	35+60+60	4.20	4.13	2.37	4.06	4.06	-	-	1.4	10.5	11.3	430	2540	2900	11.7	11.2	10.7	
50+50+50	4.20	4.13	3.50	3.50	3.50	-	-	1.4	10.5	11.3	430	2540	2900	11.7	11.2	10.7		
50+50+60	4.20	4.13	3.28	3.28	3.94	-	-	1.4	10.5	11.3	430	2540	2900	11.7	11.2	10.7		
4 units	20+20+20+20	4.27	4.27	2.63	2.63	2.63	2.63	-	1.6	10.5	11.4	400	2460	2900	11.3	10.8	10.4	
	20+20+20+25	4.27	4.27	2.47	2.47	2.47	3.09	-	1.6	10.5	11.4	400	2460	2900	11.3	10.8	10.4	
	20+20+20+35	4.40	4.27	2.21	2.21	2.21	3.87	-	1.6	10.5	11.4	400	2460	2900	11.3	10.8	10.4	
	20+20+20+50	4.40	4.27	1.91	1.91	1.91	4.77	-	1.6	10.5	11.4	400	2460	2900	11.3	10.8	10.4	
	20+20+20+60	4.40	4.27	1.75	1.75	1.75	5.25	-	1.6	10.5	11.4	400	2460	2900	11.3	10.8	10.4	
	20+20+20+71	4.40	4.27	1.60	1.60	1.60	5.69	-	1.6	10.5	11.4	400	2460	2900	11.3	10.8	10.4	
	20+20+20+80	4.40	4.27	1.50	1.50	1.50	6.00	-	1.6	10.5	11.4	400	2460	2900	11.3	10.8	10.4	
	20+20+25+25	4.40	4.27	2.33	2.33	2.92	2.92	-	1.6	10.5	11.4	400	2460	2900	11.3	10.8	10.4	
	20+20+25+35	4.40	4.27	2.10	2.10	2.63	3.68	-	1.6	10.5	11.4	400	2460	2900	11.3	10.8	10.4	
	20+20+25+50	4.40	4.27	1.83	1.83	2.28	4.57	-	1.6	10.5	11.4	400	2460	2900	11.3	10.8	10.4	
	20+20+25+60	4.40	4.27	1.68	1.68	2.10	5.04	-	1.6	10.5	11.4	400	2460	2900	11.3	10.8	10.4	
	20+20+25+71	4.40	4.27	1.54	1.54	1.93	5.48	-	1.6	10.5	11.4	400	2460	2900	11.3	10.8	10.4	
	20+20+25+80	4.40	4.27	1.45	1.45	1.81	5.79	-	1.6	10.5	11.4	400	2460	2900	11.3	10.8	10.4	
	20+20+35+35	4.40	4.27	1.91	1.91	3.34	3.34	-	1.6	10.5	11.4	400	2460	2900	11.3	10.8	10.4	
	20+20+35+50	4.40	4.27	1.68	1.68	2.94	4.20	-	1.6	10.5	11.4	400	2460	2900	11.3	10.8	10.4	
	20+20+35+60	4.40	4.27	1.56	1.56	2.72	4.67	-	1.6	10.5	11.4	400	2460	2900	11.3	10.8	10.4	
	20+20+35+71	4.40	4.27	1.44	1.44	2.52	5.11	-	1.6	10.5	11.4	400	2460	2900	11.3	10.8	10.4	
	20+20+35+80	4.40	4.27	1.35	1.35	2.37	5.42	-	1.6	10.5	11.4	400	2460	2900	11.3	10.8	10.4	
	20+20+50+50	4.40	4.27	1.50	1.50	3.75	3.75	-	1.6	10.5	11.4	400	2460	2900	11.3	10.8	10.4	
	20+20+50+60	4.40	4.27	1.40	1.40	3.50	4.20	-	1.6	10.5	11.4	400	2460	2900	11.3	10.8	10.4	
	20+20+60+60	4.40	4.27	1.31	1.31	3.94	3.94	-	1.6	10.5	11.4	400	2460	2900	11.3	10.8	10.4	
	20+25+25+25	4.40	4.27	2.21	2.76	2.76	2.76	-	1.6	10.5	11.4	400	2460	2900	11.3	10.8	10.4	
	20+25+25+35	4.40	4.27	2.00	2.50	2.50	3.50	-	1.6	10.5	11.4	400	2460	2900	11.3	10.8	10.4	
	20+25+25+50	4.40	4.27	1.75	2.19	2.19	4.38	-	1.6	10.5	11.4	400	2460	2900	11.3	10.8	10.4	
	20+25+25+60	4.40	4.27	1.62	2.02	2.02	4.85	-	1.6	10.5	11.4	400	2460	2900	11.3	10.8	10.4	
	20+25+25+71	4.40	4.27	1.49	1.86	1.86	5.29	-	1.6	10.5	11.4	400	2460	2900	11.3	10.8	10.4	
	20+25+25+80	4.40	4.27	1.40	1.75	1.75	5.60	-	1.6	10.5	11.4	400	2460	2900	11.3	10.8	10.4	
	20+25+35+35	4.40	4.27	1.83	2.28	3.20	3.20	-	1.6	10.5	11.4	400	2460	2900	11.3	10.8	10.4	
	20+25+35+50	4.40	4.27	1.62	2.02	2.83	4.04	-	1.6	10.5	11.4	400	2460	2900	11.3	10.8	10.4	
	20+25+35+60	4.40	4.27	1.50	1.88	2.63	4.50	-	1.6	10.5	11.4	400	2460	2900	11.3	10.8	10.4	
	20+25+35+71	4.40	4.27	1.39	1.74	2.43	4.94	-	1.6	10.5	11.4	400	2460	2900	11.3	10.8	10.4	
	20+25+35+80	4.40	4.27	1.31	1.64	2.30	5.25	-	1.6	10.5	11.4	400	2460	2900	11.3	10.8	10.4	
	20+25+50+50	4.40	4.27	1.45	1.81	3.62	3.62	-	1.6	10.5	11.4	400	2460	2900	11.3	10.8	10.4	
	20+25+50+60	4.40	4.27	1.35	1.69	3.39	4.06	-	1.6	10.5	11.4	400	2460	2900	11.3	10.8	10.4	
	20+35+35+35	4.40	4.27	1.68	2.94	2.94	2.94	-	1.6	10.5	11.4	400	2460	2900	11.3	10.8	10.4	
	20+35+35+50	4.40	4.27	1.50	2.63	2.63	3.75	-	1.6	10.5	11.4	400	2460	2900	11.3	10.8	10.4	
	20+35+35+60	4.40	4.27	1.40	2.45	2.45	4.20	-	1.6	10.5	11.4	400	2460	2900	11.3	10.8	10.4	
	20+35+50+50	4.40	4.27	1.35	2.37	3.39	3.39	-	1.6	10.5	11.4	400	2460	2900	11.3	10.8	10.4	
	25+25+25+25	4.40	4.27	2.63	2.63	2.63	2.63	-	1.6	10.5	11.4	400	2460	2900	11.3	10.8	10.4	
	25+25+25+35	4.40	4.27	2.39	2.39	2.39	3.34	-	1.6	10.5	11.4	400	2460	2900	11.3	10.8	10.4	
	25+25+25+50	4.40	4.27	2.10	2.10	2.10	4.20	-	1.6	10.5	11.4	400	2460	2900	11.3	10.8	10.4	
	25+25+25+60	4.40	4.27	1.94	1.94	1.94	4.67	-	1.6	10.5	11.4	400	2460	2900	11.3	10.8	10.4	
	25+25+25+71	4.40	4.27	1.80	1.80	1.80	5.11	-	1.6	10.5	11.4	400	2460	2900	11.3	10.8	10.4	
	25+25+25+80	4.40	4.27	1.69	1.69	1.69	5.42	-	1.6	10.5	11.4	400	2460	2900	11.3	10.8	10.4	
	25+25+35+35	4.40	4.27	2.19	2.19	3.06	3.06	-	1.6	10.5	11.4	400	2460	2900	11.3	10.8	10.4	
	25+25+35+50	4.40	4.27	1.94	1.94	2.72	3.89	-	1.6	10.5	11.4	400	2460	2900	11.3	10.8	10.4	
25+25+35+60	4.40	4.27	1.81	1.81	2.53	4.34	-	1.6	10.5	11.4	400	2460	2900	11.3	10.8	10.4		
25+25+35+71	4.40	4.27	1.68	1.68	2.36	4.78	-	1.6	10.5	11.4	400	2460	2900	11.3	10.8	10.4		
25+25+50+50	4.40	4.27	1.75	1.75	3.50	3.50	-	1.6	10.5	11.4	400	2460	2900	11.3	10.8	10.4		
25+25+50+60	4.40	4.27	1.64	1.64	3.28	3.94	-	1.6	10.5	11.4	400	2460	2900	11.3	10.8	10.4		
25+35+35+35	4.40	4.27	2.02	2.83	2.83	2.83	-	1.6	10.5	11.4	400	2460	2900	11.3	10.8	10.4		
25+35+35+50	4.40	4.27	1.81	2.53	2.53	3.62	-	1.6	10.5	11.4	400	2460	2900	11.3	10.8	10.4		
25+35+35+60	4.40	4.27	1.69	2.37	2.37	4.06	-	1.6	10.5	11.4	400	2460	2900	11.3	10.8	10.4		
25+35+50+50	4.40	4.27	1.64	2.30	3.28	3.28	-	1.6	10.5	11.4	400	2460	2900	11.3	10.8	10.4		
35+35+35+35	4.40	4.27	2.63	2.63	2.63	2.63	-	1.6	10.5									

PERFORMANCE TABLES MULTISPLIT R32

SCM 100 ZS-W

HEATING		Seasonal energy efficiency	COP	Heating capacity (kW)									Power input (W)			Rated current (A)		
				Capacity for each room (kW)					Total capacity (kW)				Min.	Standard	Max.	220V	230V	240V
				A	B	C	D	E	Min.	Standard	Max.							
5 units	20+20+20+20+20	4.50	4.41	2.10	2.10	2.10	2.10	2.10	1.8	10.5	11.5	370	2380	2900	10.9	10.5	10.0	
	20+20+20+20+25	4.50	4.41	2.00	2.00	2.00	2.00	2.50	1.8	10.5	11.5	370	2380	2900	10.9	10.5	10.0	
	20+20+20+20+35	4.50	4.41	1.83	1.83	1.83	1.83	3.20	1.8	10.5	11.5	370	2380	2900	10.9	10.5	10.0	
	20+20+20+20+50	4.50	4.41	1.62	1.62	1.62	1.62	4.04	1.8	10.5	11.5	370	2380	2900	10.9	10.5	10.0	
	20+20+20+20+60	4.50	4.41	1.50	1.50	1.50	1.50	4.50	1.8	10.5	11.5	370	2380	2900	10.9	10.5	10.0	
	20+20+20+25+25	4.50	4.41	1.91	1.91	1.91	2.39	2.39	1.8	10.5	11.5	370	2380	2900	10.9	10.5	10.0	
	20+20+20+25+35	4.50	4.41	1.75	1.75	1.75	2.19	3.06	1.8	10.5	11.5	370	2380	2900	10.9	10.5	10.0	
	20+20+20+25+50	4.50	4.41	1.56	1.56	1.56	1.94	3.89	1.8	10.5	11.5	370	2380	2900	10.9	10.5	10.0	
	20+20+20+25+60	4.50	4.41	1.45	1.45	1.45	1.81	4.34	1.8	10.5	11.5	370	2380	2900	10.9	10.5	10.0	
	20+20+20+35+35	4.50	4.41	1.62	1.62	1.62	2.83	2.83	1.8	10.5	11.5	370	2380	2900	10.9	10.5	10.0	
	20+20+20+35+50	4.50	4.41	1.45	1.45	1.45	2.53	3.62	1.8	10.5	11.5	370	2380	2900	10.9	10.5	10.0	
	20+20+20+35+60	4.50	4.41	1.35	1.35	1.35	2.37	4.06	1.8	10.5	11.5	370	2380	2900	10.9	10.5	10.0	
	20+20+25+25+25	4.50	4.41	1.83	1.83	2.28	2.28	2.28	1.8	10.5	11.5	370	2380	2900	10.9	10.5	10.0	
	20+20+25+25+35	4.50	4.41	1.68	1.68	2.10	2.10	2.94	1.8	10.5	11.5	370	2380	2900	10.9	10.5	10.0	
	20+20+25+25+50	4.50	4.41	1.50	1.50	1.88	1.88	3.75	1.8	10.5	11.5	370	2380	2900	10.9	10.5	10.0	
	20+20+25+25+60	4.50	4.41	1.40	1.40	1.75	1.75	4.20	1.8	10.5	11.5	370	2380	2900	10.9	10.5	10.0	
	20+20+35+35+35	4.50	4.41	1.56	1.56	1.94	2.72	2.72	1.8	10.5	11.5	370	2380	2900	10.9	10.5	10.0	
	20+20+35+35+50	4.50	4.41	1.40	1.40	1.75	2.45	3.50	1.8	10.5	11.5	370	2380	2900	10.9	10.5	10.0	
	20+20+35+35+60	4.50	4.41	1.31	1.31	1.64	2.30	3.94	1.8	10.5	11.5	370	2380	2900	10.9	10.5	10.0	
	20+20+35+35+35	4.50	4.41	1.45	1.45	2.53	2.53	2.53	1.8	10.5	11.5	370	2380	2900	10.9	10.5	10.0	
	20+20+35+35+50	4.50	4.41	1.31	1.31	2.30	2.30	3.28	1.8	10.5	11.5	370	2380	2900	10.9	10.5	10.0	
	20+25+25+25+25	4.50	4.41	1.75	2.19	2.19	2.19	2.19	1.8	10.5	11.5	370	2380	2900	10.9	10.5	10.0	
	20+25+25+25+35	4.50	4.41	1.62	2.02	2.02	2.02	2.83	1.8	10.5	11.5	370	2380	2900	10.9	10.5	10.0	
	20+25+25+25+50	4.50	4.41	1.45	1.81	1.81	1.81	3.62	1.8	10.5	11.5	370	2380	2900	10.9	10.5	10.0	
	20+25+25+25+60	4.50	4.41	1.35	1.69	1.69	1.69	4.06	1.8	10.5	11.5	370	2380	2900	10.9	10.5	10.0	
	20+25+35+35+35	4.50	4.41	1.50	1.88	1.88	2.63	2.63	1.8	10.5	11.5	370	2380	2900	10.9	10.5	10.0	
	20+25+35+35+50	4.50	4.41	1.35	1.69	1.69	2.37	3.39	1.8	10.5	11.5	370	2380	2900	10.9	10.5	10.0	
	20+25+35+35+35	4.50	4.41	1.40	1.75	2.45	2.45	2.45	1.8	10.5	11.5	370	2380	2900	10.9	10.5	10.0	
	20+35+35+35+35	4.50	4.41	1.31	2.30	2.30	2.30	2.30	1.8	10.5	11.5	370	2380	2900	10.9	10.5	10.0	
	25+25+25+25+25	4.50	4.41	2.10	2.10	2.10	2.10	2.10	1.8	10.5	11.5	370	2380	2900	10.9	10.5	10.0	
25+25+25+25+35	4.50	4.41	1.94	1.94	1.94	1.94	2.72	1.8	10.5	11.5	370	2380	2900	10.9	10.5	10.0		
25+25+25+25+50	4.50	4.41	1.75	1.75	1.75	1.75	3.50	1.8	10.5	11.5	370	2380	2900	10.9	10.5	10.0		
25+25+25+25+60	4.50	4.41	1.64	1.64	1.64	1.64	3.94	1.8	10.5	11.5	370	2380	2900	10.9	10.5	10.0		
25+25+35+35+35	4.50	4.41	1.81	1.81	1.81	2.53	2.53	1.8	10.5	11.5	370	2380	2900	10.9	10.5	10.0		
25+25+35+35+50	4.50	4.41	1.64	1.64	1.64	2.30	3.28	1.8	10.5	11.5	370	2380	2900	10.9	10.5	10.0		
25+25+35+35+35	4.50	4.41	1.69	1.69	2.37	2.37	2.37	1.8	10.5	11.5	370	2380	2900	10.9	10.5	10.0		

SCOP = EU Regulation N. 206/2012 – Value measured in according to harmonized rule EN14825.
 COP = Value measured in according to harmonized rule EN 14511.

PERFORMANCE TABLES MULTISPLIT R32

SCM 100 ZS-W

COOLING		Seasonal energy efficiency	EER	Cooling capacity (kW)									Power input (W)			Rated current (A)		
				Capacity for each room (kW)					Total capacity (kW)				Min.	Standard	Max.	220V	230V	240V
				A	B	C	D	E	Min.	Standard	Max.							
1 unit	20		3.77	2.00	-	-	-	-	1.7	2.0	2.7	500	530	950	2.5	2.4	2.3	
	25		3.62	2.50	-	-	-	-	1.7	2.5	3.2	500	690	1008	3.3	3.1	3.0	
	35		3.47	3.50	-	-	-	-	1.7	3.5	3.7	500	1010	1340	4.8	4.6	4.4	
	50		3.36	5.00	-	-	-	-	1.7	5.0	5.8	500	1490	1730	6.9	6.6	6.3	
	60		3.31	6.00	-	-	-	-	1.7	6.0	6.7	500	1810	1990	8.3	8.0	7.6	
	71		3.27	7.10	-	-	-	-	1.7	7.1	7.2	500	2170	2270	10.1	9.6	9.2	
2 units	20 + 20		4.71	2.00	2.00	-	-	-	1.9	4.0	5.8	495	850	1430	4.0	3.8	3.7	
	20 + 25		4.46	2.00	2.50	-	-	-	1.9	4.5	6.1	495	1010	1540	4.7	4.5	4.3	
	20 + 35		4.14	2.00	3.50	-	-	-	1.9	5.5	6.6	495	1330	1720	6.2	5.9	5.7	
	20 + 50		3.72	2.00	5.00	-	-	-	1.9	7.0	7.7	495	1880	2170	8.6	8.2	7.9	
	20 + 60		3.48	2.00	6.00	-	-	-	1.9	8.0	8.8	495	2300	2690	10.7	10.2	9.8	
	20 + 71		6.60	3.19	2.00	7.10	-	-	-	1.9	9.1	10.0	495	2850	3420	13.2	12.6	12.1
	20 + 80		6.60	2.90	2.00	8.00	-	-	-	1.9	10.0	10.3	495	3450	3650	16.0	15.3	14.7
	25 + 25		6.60	4.27	2.50	2.50	-	-	-	1.9	5.0	6.5	495	1170	1690	5.4	5.2	5.0
	25 + 35		6.60	3.75	2.50	3.50	-	-	-	1.9	6.0	6.8	495	1600	1800	7.4	7.1	6.8
	25 + 50		6.60	3.61	2.50	5.00	-	-	-	1.9	7.5	8.4	495	2080	2490	9.6	9.2	8.8
	25 + 60		6.60	3.23	2.50	6.00	-	-	-	1.9	8.5	9.4	495	2630	3020	12.2	11.7	11.2
	25 + 71		6.60	3.06	2.50	7.10	-	-	-	1.9	9.6	10.2	495	3140	3570	14.6	13.9	13.4
	25 + 80		6.60	2.90	2.38	7.62	-	-	-	1.9	10.0	10.3	495	3450	3650	16.0	15.3	14.7
	35 + 35		6.60	3.72	3.50	3.50	-	-	-	1.9	7.0	7.7	495	1880	2170	8.6	8.2	7.9
	35 + 50		6.60	3.23	3.50	5.00	-	-	-	1.9	8.5	9.4	495	2630	3020	12.2	11.7	11.2
	35 + 60		6.60	3.08	3.50	6.00	-	-	-	1.9	9.5	10.2	495	3080	3570	14.3	13.7	13.1
	35 + 71		6.60	2.90	3.30	6.70	-	-	-	1.9	10.0	10.3	495	3450	3650	16.0	15.3	14.7
	35 + 80		6.60	2.90	3.04	6.96	-	-	-	1.9	10.0	10.3	495	3450	3650	16.0	15.3	14.7
	50 + 50		6.60	2.90	5.00	5.00	-	-	-	1.9	10.0	10.3	495	3450	3650	16.0	15.3	14.7
	50 + 60		6.60	2.90	4.55	5.45	-	-	-	1.9	10.0	10.3	495	3450	3650	16.0	15.3	14.7
	50 + 71		6.60	2.90	4.13	5.87	-	-	-	1.9	10.0	10.3	495	3450	3650	16.0	15.3	14.7
	50 + 80		6.60	2.90	3.85	6.15	-	-	-	1.9	10.0	10.3	495	3450	3650	16.0	15.3	14.7
	60 + 60		6.60	2.90	5.00	5.00	-	-	-	1.9	10.0	10.3	495	3450	3650	16.0	15.3	14.7
	60 + 71		6.60	2.90	4.58	5.42	-	-	-	1.9	10.0	10.3	495	3450	3650	16.0	15.3	14.7
	60 + 80		6.60	2.90	4.29	5.71	-	-	-	1.9	10.0	10.3	495	3450	3650	16.0	15.3	14.7
	71 + 71		6.60	2.90	5.00	5.00	-	-	-	1.9	10.0	10.3	495	3450	3650	16.0	15.3	14.7
	71 + 80		6.60	2.90	4.70	5.30	-	-	-	1.9	10.0	10.3	495	3450	3650	16.0	15.3	14.7
	80 + 80		6.60	2.90	5.00	5.00	-	-	-	1.9	10.0	10.3	495	3450	3650	16.0	15.3	14.7
3 units	20+20+20		4.20	2.00	2.00	2.00	-	-	2.1	6.0	7.4	490	1430	1930	6.6	6.3	6.1	
	20+20+25		4.06	2.00	2.00	2.50	-	-	2.1	6.5	7.7	490	1600	2050	7.4	7.1	6.8	
	20+20+35		3.81	2.00	2.00	3.50	-	-	2.1	7.5	8.6	490	1970	2430	9.1	8.7	8.4	
	20+20+50		7.30	3.45	2.00	2.00	5.00	-	-	2.1	9.0	9.6	490	2610	2920	12.1	11.6	11.1
	20+20+60		7.30	3.10	2.00	2.00	6.00	-	-	2.1	10.0	10.7	490	3230	3650	15.0	14.3	13.7
	20+20+71		7.30	3.10	1.80	1.80	6.40	-	-	2.1	10.0	10.7	490	3230	3650	15.0	14.3	13.7
	20+20+80		7.30	3.10	1.67	1.67	6.67	-	-	2.1	10.0	10.7	490	3230	3650	15.0	14.3	13.7
	20+25+25		7.30	3.93	2.00	2.50	2.50	-	-	2.1	7.0	8.0	490	1780	2170	8.2	7.8	7.5
	20+25+35		7.30	3.69	2.00	2.50	3.50	-	-	2.1	8.0	9.0	490	2170	2160	10.1	9.6	9.2
	20+25+50		7.30	3.31	2.00	2.50	5.00	-	-	2.1	9.5	10.3	490	2870	3340	13.3	12.7	12.2
	20+25+60		7.30	3.10	1.90	2.38	5.71	-	-	2.1	10.0	10.7	490	3230	3650	15.0	14.3	13.7
	20+35+35		7.30	3.45	2.00	3.50	3.50	-	-	2.1	9.0	9.6	490	2610	2920	12.1	11.6	11.1
	20+35+50		7.30	3.10	1.90	3.33	4.76	-	-	2.1	10.0	10.7	490	3230	3650	15.0	14.3	13.7
	20+35+60		7.30	3.10	1.74	3.04	5.22	-	-	2.1	10.0	10.7	490	3230	3650	15.0	14.3	13.7
	20+35+71		7.30	3.10	1.59	2.78	5.63	-	-	2.1	10.0	10.7	490	3230	3650	15.0	14.3	13.7
	20+35+80		7.30	3.10	1.48	2.59	5.93	-	-	2.1	10.0	10.7	490	3230	3650	15.0	14.3	13.7
	20+50+50		7.30	3.10	1.67	4.17	4.17	-	-	2.1	10.0	10.7	490	3230	3650	15.0	14.3	13.7
	20+50+60		7.30	3.10	1.54	3.85	4.62	-	-	2.1	10.0	10.7	490	3230	3650	15.0	14.3	13.7
	20+50+71		7.30	3.10	1.42	3.55	5.04	-	-	2.1	10.0	10.7	490	3230	3650	15.0	14.3	13.7
	20+50+80		7.30	3.10	1.33	3.33	5.33	-	-	2.1	10.0	10.7	490	3230	3650	15.0	14.3	13.7
	20+60+60		7.30	3.10	1.43	4.29	4.29	-	-	2.1	10.0	10.7	490	3230	3650	15.0	14.3	13.7
	20+60+71		7.30	3.10	1.32	3.97	4.70	-	-	2.1	10.0	10.7	490	3230	3650	15.0	14.3	13.7
	20+60+80		7.30	3.10	1.25	3.75	5.00	-	-	2.1	10.0	10.7	490	3230	3650	15.0	14.3	13.7
	25+25+25		7.30	3.81	2.50	2.50	2.50	-	-	2.1	7.5	8.6	490	1970	2430	9.1	8.7	8.4
	25+25+35		7.30	3.57	2.50	2.50	3.50	-	-	2.1	8.5	9.2	490	2380	2710	11.0	10.6	10.1
	25+25+50		7.30	3.10	2.50	2.50	5.00	-	-	2.1	10.0	10.7	490	3230	3650	15.0	14.3	13.7
	25+25+60		7.30	3.10	2.27	2.27	5.45	-	-	2.1	10.0	10.7	490	3230	3650	15.0	14.3	13.7
	25+25+71		7.30	3.10	2.07	2.07	5.87	-	-	2.1	10.0	10.7	490	3230	3650	15.0	14.3	13.7
	25+25+80		7.30	3.10	1.92	1.92	6.15	-	-	2.1	10.0	10.7	490	3230	3650	15.0	14.3	13.7
	25+35+35		7.30	3.31	2.50	3.50	3.50	-	-	2.1	9.5	10.3	490	2870	3340	13.3	12.7	12.2
	25+35+50		7.30	3.10	2.27	3.18	4.55	-	-	2.1	10.0	10.7	490	3230	3650	15.0	14.3	13.7
	25+35+60		7.30	3.10	2.08	2.92	5.00	-	-	2.1	10.0	10.7	490	3230	3650	15.0	14.3	13.7
	25+35+71		7.30	3.10	1.91	2.67	5.42	-	-	2.1	10.0	10.7	490	3230	3650	15.0	14.3	13.7
	25+35+80		7.30	3.10	1.79	2.50	5.71	-	-	2.1	10.0	10.7	490	3230	3650	15.0	14.3	13.7
	25+50+50		7.30	3.10	2.00	4.00	4.00	-	-	2.1	10.0	10.7	490	3230	3650	15.0	14.3	13.7
	25+50+60		7.30	3.10	1.85	3.70	4.44	-	-	2.1	10.0	10.7	490	3230	3650	15.0	14.3	13.7
25+50+71	7.30	3.10	1.71	3.42	4.86	-	-	2.1	10.0	10.7	490	3230	3650	15.0	14.3	13.7		
25+50+80	7.30	3.10	1.61	3.23	5.16	-	-	2.1	10.0	10.7	490	3230	3650	15.0	14.3	13.7		

SEER = EU Regulation N. 206/2012 – Value measured in according to harmonized rule EN14825.
 EER = Value measured in according to harmonized rule EN 14

PERFORMANCE TABLES MULTISPLIT R32

R32

SCM 100 ZS-W

COOLING		Seasonal energy efficiency	EER	Cooling capacity (kW)									Power input (W)			Rated current (A)		
				Capacity for each room (kW)					Total capacity (kW)				Min.	Standard	Max.	220V	230V	240V
Combined units		SEER	A	B	C	D	E	Min.	Standard	Max.								
3 units	25+60+60										7.30	3.10	1.72	4.14	4.14	-	-	2.1
	25+60+71	7.30	3.10	1.60	3.85	4.55	-	-	2.1	10.0	10.7	490	3230	3650	15.0	14.3	13.7	
	35+35+35	7.30	3.10	3.33	3.33	3.33	-	-	2.1	10.0	10.7	490	3230	3650	15.0	14.3	13.7	
	35+35+50	7.30	3.10	2.92	2.92	4.17	-	-	2.1	10.0	10.7	490	3230	3650	15.0	14.3	13.7	
	35+35+60	7.30	3.10	2.69	2.69	4.62	-	-	2.1	10.0	10.7	490	3230	3650	15.0	14.3	13.7	
	35+35+71	7.30	3.10	2.48	2.48	5.04	-	-	2.1	10.0	10.7	490	3230	3650	15.0	14.3	13.7	
	35+35+80	7.30	3.10	2.33	2.33	5.33	-	-	2.1	10.0	10.7	490	3230	3650	15.0	14.3	13.7	
	35+50+50	7.30	3.10	2.59	3.70	3.70	-	-	2.1	10.0	10.7	490	3230	3650	15.0	14.3	13.7	
	35+50+60	7.30	3.10	2.41	3.45	4.14	-	-	2.1	10.0	10.7	490	3230	3650	15.0	14.3	13.7	
	35+50+71	7.30	3.10	2.24	3.21	4.55	-	-	2.1	10.0	10.7	490	3230	3650	15.0	14.3	13.7	
	35+60+60	7.30	3.10	2.26	3.87	3.87	-	-	2.1	10.0	10.7	490	3230	3650	15.0	14.3	13.7	
	50+50+50	7.30	3.10	3.33	3.33	3.33	-	-	2.1	10.0	10.7	490	3230	3650	15.0	14.3	13.7	
50+50+60	7.30	3.10	3.13	3.13	3.75	-	-	2.1	10.0	10.7	490	3230	3650	15.0	14.3	13.7		
4 units	20+20+20+20		3.96	2.00	2.00	2.00	2.00	-	2.3	8.0	8.8	485	2020	2330	9.4	9.0	8.6	
	20+20+20+25		3.85	2.00	2.00	2.00	2.50	-	2.3	8.5	9.4	485	2210	2590	10.3	9.8	9.4	
	20+20+20+35	7.90	3.60	2.00	2.00	2.00	3.50	-	2.3	9.5	10.5	485	2640	3150	12.2	11.7	11.2	
	20+20+20+50	7.90	3.39	1.82	1.82	1.82	4.55	-	2.3	10.0	11.3	485	2950	3650	13.7	13.1	12.5	
	20+20+20+60	7.90	3.39	1.67	1.67	1.67	5.00	-	2.3	10.0	11.3	485	2950	3650	13.7	13.1	12.5	
	20+20+20+71	7.90	3.39	1.53	1.53	1.53	5.42	-	2.3	10.0	11.3	485	2950	3650	13.7	13.1	12.5	
	20+20+20+80	7.90	3.39	1.43	1.43	1.43	5.71	-	2.3	10.0	11.3	485	2950	3650	13.7	13.1	12.5	
	20+20+25+25	7.90	3.72	2.00	2.00	2.50	2.50	-	2.3	9.0	9.9	485	2420	2830	11.2	10.7	10.3	
	20+20+25+35	7.90	3.39	2.00	2.00	2.50	3.50	-	2.3	10.0	11.3	485	2950	3650	13.7	13.1	12.5	
	20+20+25+50	7.90	3.39	1.74	1.74	2.17	4.35	-	2.3	10.0	11.3	485	2950	3650	13.7	13.1	12.5	
	20+20+25+60	7.90	3.39	1.60	1.60	2.00	4.80	-	2.3	10.0	11.3	485	2950	3650	13.7	13.1	12.5	
	20+20+25+71	7.90	3.39	1.47	1.47	1.84	5.22	-	2.3	10.0	11.3	485	2950	3650	13.7	13.1	12.5	
	20+20+25+80	7.90	3.39	1.38	1.38	1.72	5.52	-	2.3	10.0	11.3	485	2950	3650	13.7	13.1	12.5	
	20+20+35+35	7.90	3.39	1.82	1.82	3.18	3.18	-	2.3	10.0	11.3	485	2950	3650	13.7	13.1	12.5	
	20+20+35+50	7.90	3.39	1.60	1.60	2.80	4.00	-	2.3	10.0	11.3	485	2950	3650	13.7	13.1	12.5	
	20+20+35+60	7.90	3.39	1.48	1.48	2.59	4.44	-	2.3	10.0	11.3	485	2950	3650	13.7	13.1	12.5	
	20+20+35+71	7.90	3.39	1.37	1.37	2.40	4.86	-	2.3	10.0	11.3	485	2950	3650	13.7	13.1	12.5	
	20+20+35+80	7.90	3.39	1.29	1.29	2.26	5.16	-	2.3	10.0	11.3	485	2950	3650	13.7	13.1	12.5	
	20+20+50+50	7.90	3.39	1.43	1.43	3.57	3.57	-	2.3	10.0	11.3	485	2950	3650	13.7	13.1	12.5	
	20+20+50+60	7.90	3.39	1.33	1.33	3.33	4.00	-	2.3	10.0	11.3	485	2950	3650	13.7	13.1	12.5	
	20+20+60+60	7.90	3.39	1.25	1.25	3.75	3.75	-	2.3	10.0	11.3	485	2950	3650	13.7	13.1	12.5	
	20+25+25+25	7.90	3.60	2.00	2.00	2.50	2.50	-	2.3	9.5	10.5	485	2640	3150	12.2	11.7	11.2	
	20+25+25+35	7.90	3.39	1.90	2.38	2.38	3.33	-	2.3	10.0	11.1	485	2950	3650	13.7	13.1	12.5	
	20+25+25+50	7.90	3.39	1.67	2.08	2.08	4.17	-	2.3	10.0	11.1	485	2950	3650	13.7	13.1	12.5	
	20+25+25+60	7.90	3.39	1.54	1.92	1.92	4.62	-	2.3	10.0	11.1	485	2950	3650	13.7	13.1	12.5	
	20+25+25+71	7.90	3.39	1.42	1.77	1.77	5.04	-	2.3	10.0	11.1	485	2950	3650	13.7	13.1	12.5	
	20+25+25+80	7.90	3.39	1.33	1.67	1.67	5.33	-	2.3	10.0	11.1	485	2950	3650	13.7	13.1	12.5	
	20+25+35+35	7.90	3.39	1.74	2.17	3.04	3.04	-	2.3	10.0	11.1	485	2950	3650	13.7	13.1	12.5	
	20+25+35+50	7.90	3.39	1.54	1.92	2.69	3.85	-	2.3	10.0	11.1	485	2950	3650	13.7	13.1	12.5	
	20+25+35+60	7.90	3.39	1.43	1.79	2.50	4.29	-	2.3	10.0	11.1	485	2950	3650	13.7	13.1	12.5	
	20+25+35+71	7.90	3.39	1.32	1.66	2.32	4.70	-	2.3	10.0	11.1	485	2950	3650	13.7	13.1	12.5	
	20+25+35+80	7.90	3.39	1.25	1.56	2.19	5.00	-	2.3	10.0	11.1	485	2950	3650	13.7	13.1	12.5	
	20+25+50+50	7.90	3.39	1.38	1.72	3.45	3.45	-	2.3	10.0	11.1	485	2950	3650	13.7	13.1	12.5	
	20+25+50+60	7.90	3.39	1.29	1.61	3.23	3.87	-	2.3	10.0	11.1	485	2950	3650	13.7	13.1	12.5	
	20+35+35+35	7.90	3.39	1.60	2.80	2.80	2.80	-	2.3	10.0	11.1	485	2950	3650	13.7	13.1	12.5	
	20+35+35+50	7.90	3.39	1.43	2.50	2.50	3.57	-	2.3	10.0	11.1	485	2950	3650	13.7	13.1	12.5	
	20+35+35+60	7.90	3.39	1.33	2.33	2.33	4.00	-	2.3	10.0	11.1	485	2950	3650	13.7	13.1	12.5	
	20+35+50+50	7.90	3.39	1.29	2.26	3.23	3.23	-	2.3	10.0	11.1	485	2950	3650	13.7	13.1	12.5	
	25+25+25+25	7.90	3.39	2.50	2.50	2.50	2.50	-	2.3	10.0	11.1	485	2950	3650	13.7	13.1	12.5	
	25+25+25+35	7.90	3.39	2.27	2.27	2.27	3.18	-	2.3	10.0	11.1	485	2950	3650	13.7	13.1	12.5	
	25+25+25+50	7.90	3.39	2.00	2.00	2.00	4.00	-	2.3	10.0	11.1	485	2950	3650	13.7	13.1	12.5	
	25+25+25+60	7.90	3.39	1.85	1.85	1.85	4.44	-	2.3	10.0	11.1	485	2950	3650	13.7	13.1	12.5	
	25+25+25+71	7.90	3.39	1.71	1.71	1.71	4.86	-	2.3	10.0	11.1	485	2950	3650	13.7	13.1	12.5	
25+25+25+80	7.90	3.39	1.61	1.61	1.61	5.16	-	2.3	10.0	11.1	485	2950	3650	13.7	13.1	12.5		
25+25+35+35	7.90	3.39	2.08	2.08	2.92	2.92	-	2.3	10.0	11.1	485	2950	3650	13.7	13.1	12.5		
25+25+35+50	7.90	3.39	1.85	1.85	2.59	3.70	-	2.3	10.0	11.1	485	2950	3650	13.7	13.1	12.5		
25+25+35+60	7.90	3.39	1.72	1.72	2.41	4.14	-	2.3	10.0	11.1	485	2950	3650	13.7	13.1	12.5		
25+25+35+71	7.90	3.39	1.60	1.60	2.24	4.55	-	2.3	10.0	11.1	485	2950	3650	13.7	13.1	12.5		
25+25+50+50	7.90	3.39	1.67	1.67	3.33	3.33	-	2.3	10.0	11.1	485	2950	3650	13.7	13.1	12.5		
25+25+50+60	7.90	3.39	1.56	1.56	3.13	3.75	-	2.3	10.0	11.1	485	2950	3650	13.7	13.1	12.5		
25+35+35+35	7.90	3.39	1.92	2.69	2.69	2.69	-	2.3	10.0	11.1	485	2950	3650	13.7	13.1	12.5		
25+35+35+50	7.90	3.39	1.72	2.41	2.41	3.45	-	2.3	10.0	11.1	485	2950	3650	13.7	13.1	12.5		
25+35+35+60	7.90	3.39	1.61	2.26	2.26	3.87	-	2.3	10.0	11.1	485	2950	3650	13.7	13.1	12.5		
25+35+50+50	7.90	3.39	1.56	2.19	3.13	3.13	-	2.3	10.0	11.1	485	2950	3650	13.7	13.1	12.5		
35+35+35+35	7.90	3.39	2.50	2.50	2.50	2.50	-	2.3	10.0	11.1	485	2950	3650	13.7	13.1	12.5		
35+35+35+50	7.90	3.39	2.26	2.26	2.26	3.23	-	2.3	10.0	11.1	485	2950	3650	13.7	13.1	12.5		

SEER = EU Regulation N. 206/2012 – Value measured in according to harmonized rule EN14825.
EER = Value measured in according to harmonized rule EN 14511.

PERFORMANCE TABLES MULTISPLIT R32

SCM 100 ZS-W

COOLING		Seasonal energy efficiency	EER	Cooling capacity (kW)									Power input (W)			Rated current (A)		
				Capacity for each room (kW)					Total capacity (kW)				Min.	Standard	Max.	220V	230V	240V
				A	B	C	D	E	Min.	Standard	Max.							
5 units	20+20+20+20+20	8.60	3.70	2.00	2.00	2.00	2.00	2.00	2.5	10.0	11.5	480	2700	3650	12.4	11.9	11.4	
	20+20+20+20+25	8.60	3.70	1.90	1.90	1.90	1.90	2.38	2.5	10.0	11.5	480	2700	3650	12.4	11.9	11.4	
	20+20+20+20+35	8.60	3.70	1.74	1.74	1.74	1.74	3.04	2.5	10.0	11.5	480	2700	3650	12.4	11.9	11.4	
	20+20+20+20+50	8.60	3.70	1.54	1.54	1.54	1.54	3.85	2.5	10.0	11.5	480	2700	3650	12.4	11.9	11.4	
	20+20+20+20+60	8.60	3.70	1.43	1.43	1.43	1.43	4.29	2.5	10.0	11.5	480	2700	3650	12.4	11.9	11.4	
	20+20+20+25+25	8.60	3.70	1.82	1.82	1.82	2.27	2.27	2.5	10.0	11.5	480	2700	3650	12.4	11.9	11.4	
	20+20+20+25+35	8.60	3.70	1.67	1.67	1.67	2.08	2.92	2.5	10.0	11.5	480	2700	3650	12.4	11.9	11.4	
	20+20+20+25+50	8.60	3.70	1.48	1.48	1.48	1.85	3.70	2.5	10.0	11.5	480	2700	3650	12.4	11.9	11.4	
	20+20+20+25+60	8.60	3.70	1.38	1.38	1.38	1.72	4.14	2.5	10.0	11.5	480	2700	3650	12.4	11.9	11.4	
	20+20+20+35+35	8.60	3.70	1.54	1.54	1.54	2.69	2.69	2.5	10.0	11.5	480	2700	3650	12.4	11.9	11.4	
	20+20+20+35+50	8.60	3.70	1.38	1.38	1.38	2.41	3.45	2.5	10.0	11.5	480	2700	3650	12.4	11.9	11.4	
	20+20+20+35+60	8.60	3.70	1.29	1.29	1.29	2.26	3.87	2.5	10.0	11.5	480	2700	3650	12.4	11.9	11.4	
	20+20+25+25+25	8.60	3.70	1.74	1.74	2.17	2.17	2.17	2.5	10.0	11.5	480	2700	3650	12.4	11.9	11.4	
	20+20+25+25+35	8.60	3.70	1.60	1.60	2.00	2.00	2.80	2.5	10.0	11.5	480	2700	3650	12.4	11.9	11.4	
	20+20+25+25+50	8.60	3.70	1.43	1.43	1.79	1.79	3.57	2.5	10.0	11.5	480	2700	3650	12.4	11.9	11.4	
	20+20+25+25+60	8.60	3.70	1.33	1.33	1.67	1.67	4.00	2.5	10.0	11.5	480	2700	3650	12.4	11.9	11.4	
	20+20+35+35+35	8.60	3.70	1.48	1.48	1.85	2.59	2.59	2.5	10.0	11.5	480	2700	3650	12.4	11.9	11.4	
	20+20+35+35+50	8.60	3.70	1.33	1.33	1.67	2.33	3.33	2.5	10.0	11.5	480	2700	3650	12.4	11.9	11.4	
	20+20+35+35+60	8.60	3.70	1.25	1.25	1.56	2.19	3.75	2.5	10.0	11.5	480	2700	3650	12.4	11.9	11.4	
	20+20+35+35+35	8.60	3.70	1.38	1.38	2.41	2.41	2.41	2.5	10.0	11.5	480	2700	3650	12.4	11.9	11.4	
	20+20+35+35+50	8.60	3.70	1.25	1.25	2.19	2.19	3.13	2.5	10.0	11.5	480	2700	3650	12.4	11.9	11.4	
	20+25+25+25+25	8.60	3.70	1.67	2.08	2.08	2.08	2.08	2.5	10.0	11.5	480	2700	3650	12.4	11.9	11.4	
	20+25+25+25+35	8.60	3.70	1.54	1.92	1.92	1.92	2.69	2.5	10.0	11.5	480	2700	3650	12.4	11.9	11.4	
	20+25+25+25+50	8.60	3.70	1.38	1.72	1.72	1.72	3.45	2.5	10.0	11.5	480	2700	3650	12.4	11.9	11.4	
	20+25+25+25+60	8.60	3.70	1.29	1.61	1.61	1.61	3.87	2.5	10.0	11.5	480	2700	3650	12.4	11.9	11.4	
	20+25+35+35+35	8.60	3.70	1.43	1.79	1.79	2.50	2.50	2.5	10.0	11.5	480	2700	3650	12.4	11.9	11.4	
	20+25+35+35+50	8.60	3.70	1.29	1.61	1.61	2.26	3.23	2.5	10.0	11.5	480	2700	3650	12.4	11.9	11.4	
	20+25+35+35+35	8.60	3.70	1.33	1.67	2.33	2.33	2.33	2.5	10.0	11.5	480	2700	3650	12.4	11.9	11.4	
	20+35+35+35+35	8.60	3.70	1.25	2.19	2.19	2.19	2.19	2.5	10.0	11.5	480	2700	3650	12.4	11.9	11.4	
	25+25+25+25+25	8.60	3.70	2.00	2.00	2.00	2.00	2.00	2.5	10.0	11.5	480	2700	3650	12.4	11.9	11.4	
25+25+25+25+35	8.60	3.70	1.85	1.85	1.85	1.85	2.59	2.5	10.0	11.5	480	2700	3650	12.4	11.9	11.4		
25+25+25+25+50	8.60	3.70	1.67	1.67	1.67	1.67	3.33	2.5	10.0	11.5	480	2700	3650	12.4	11.9	11.4		
25+25+25+25+60	8.60	3.70	1.56	1.56	1.56	1.56	3.75	2.5	10.0	11.5	480	2700	3650	12.4	11.9	11.4		
25+25+35+35+35	8.60	3.70	1.72	1.72	1.72	2.41	2.41	2.5	10.0	11.5	480	2700	3650	12.4	11.9	11.4		
25+25+35+35+50	8.60	3.70	1.56	1.56	1.56	2.19	3.13	2.5	10.0	11.5	480	2700	3650	12.4	11.9	11.4		
25+25+35+35+35	8.60	3.70	1.61	1.61	2.26	2.26	2.26	2.5	10.0	11.5	480	2700	3650	12.4	11.9	11.4		

SEER = EU Regulation N. 206/2012 – Value measured in according to harmonized rule EN14825.
 EER = Value measured in according to harmonized rule EN 14511.



Due to the continuous technological evolution of the products, we reserve the right to vary the technical specifications within this catalog at any time and without giving notice. The products depicted are only examples of the application types. The data is measured under the following conditions (ISO-T1). Cooling: internal ambient temperature 27°C DB, 19°C WB and external temperature 35°C DB; heating: internal ambient temperature 20°C DB, and external temperature 7°C DB, 6°C WB. The energy efficiency values refer to measurements carried out following the harmonized standard EN 14511:3.



04-2024



TERMAL SALES S.r.l.



Via della Salute 14 | 40132 Bologna | Italia
tel. +39 051 41 33 111 | fax +39 051 41 33 112
www.mitsubishi-termal.it